



Is Now Part of



**ON Semiconductor®**

To learn more about ON Semiconductor, please visit our website at  
[www.onsemi.com](http://www.onsemi.com)

ON Semiconductor and the ON Semiconductor logo are trademarks of Semiconductor Components Industries, LLC dba ON Semiconductor or its subsidiaries in the United States and/or other countries. ON Semiconductor owns the rights to a number of patents, trademarks, copyrights, trade secrets, and other intellectual property. A listing of ON Semiconductor's product/patent coverage may be accessed at [www.onsemi.com/site/pdf/Patent-Marking.pdf](http://www.onsemi.com/site/pdf/Patent-Marking.pdf). ON Semiconductor reserves the right to make changes without further notice to any products herein. ON Semiconductor makes no warranty, representation or guarantee regarding the suitability of its products for any particular purpose, nor does ON Semiconductor assume any liability arising out of the application or use of any product or circuit, and specifically disclaims any and all liability, including without limitation special, consequential or incidental damages. Buyer is responsible for its products and applications using ON Semiconductor products, including compliance with all laws, regulations and safety requirements or standards, regardless of any support or applications information provided by ON Semiconductor. "Typical" parameters which may be provided in ON Semiconductor data sheets and/or specifications can and do vary in different applications and actual performance may vary over time. All operating parameters, including "Typicals" must be validated for each customer application by customer's technical experts. ON Semiconductor does not convey any license under its patent rights nor the rights of others. ON Semiconductor products are not designed, intended, or authorized for use as a critical component in life support systems or any FDA Class 3 medical devices or medical devices with a same or similar classification in a foreign jurisdiction or any devices intended for implantation in the human body. Should Buyer purchase or use ON Semiconductor products for any such unintended or unauthorized application, Buyer shall indemnify and hold ON Semiconductor and its officers, employees, subsidiaries, affiliates, and distributors harmless against all claims, costs, damages, and expenses, and reasonable attorney fees arising out of, directly or indirectly, any claim of personal injury or death associated with such unintended or unauthorized use, even if such claim alleges that ON Semiconductor was negligent regarding the design or manufacture of the part. ON Semiconductor is an Equal Opportunity/Affirmative Action Employer. This literature is subject to all applicable copyright laws and is not for resale in any manner.



April 2015

# FGA40T65SHDF

## 650 V, 40 A Field Stop Trench IGBT

### Features

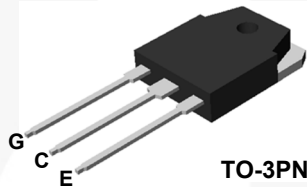
- Maximum Junction Temperature :  $T_J = 175^{\circ}\text{C}$
- Positive Temperature Co-efficient for Easy Parallel Operating
- High Current Capability
- Low Saturation Voltage:  $V_{CE(sat)} = 1.45\text{ V}$  ( Typ.) @  $I_C = 40\text{ A}$
- 100% of the Parts tested for  $I_{LM}(1)$
- High Input Impedance
- Fast Switching
- Tighten Parameter Distribution
- RoHS Compliant

### General Description

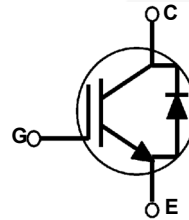
Using novel field stop IGBT technology, Fairchild's new series of field stop 3<sup>rd</sup> generation IGBTs offer superior conduction and switching performance and easy parallel operation. This device is well suited for the resonant or soft switching application such as induction heating and MWO.

### Applications

- Induction Heating, MWO



TO-3PN



### Absolute Maximum Ratings $T_C = 25^{\circ}\text{C}$ unless otherwise noted

| Symbol      | Description   | FGA40T65SHDF | Unit               |
|-------------|---|--------------|--------------------|
| $V_{CES}$   | Collector to Emitter Voltage  | 650          | V                  |
| $V_{GES}$   | Gate to Emitter Voltage   | $\pm 20$     | V                  |
|             | Transient Gate to Emitter Voltage                                       | $\pm 30$     | V                  |
| $I_C$       | Collector Current @ $T_C = 25^{\circ}\text{C}$                          | 80           | A                  |
|             | Collector Current @ $T_C = 100^{\circ}\text{C}$                         | 40           | A                  |
| $I_{LM}(1)$ | Pulsed Collector Current @ $T_C = 25^{\circ}\text{C}$                   | 120          | A                  |
| $I_{CM}(2)$ | Pulsed Collector Current  | 120          | A                  |
| $I_F$       | Diode Forward Current @ $T_C = 25^{\circ}\text{C}$                      | 40           | A                  |
|             | Diode Forward Current @ $T_C = 100^{\circ}\text{C}$                     | 20           | A                  |
| $I_{FM}$    | Pulsed Diode Maximum Forward Current                                    | 60           | A                  |
| $P_D$       | Maximum Power Dissipation @ $T_C = 25^{\circ}\text{C}$                  | 268          | W                  |
|             | Maximum Power Dissipation @ $T_C = 100^{\circ}\text{C}$                 | 134          | W                  |
| $T_J$       | Operating Junction Temperature  | -55 to +175  | $^{\circ}\text{C}$ |
| $T_{stg}$   | Storage Temperature Range   | -55 to +175  | $^{\circ}\text{C}$ |
| $T_L$       | Maximum Lead Temp. for soldering Purposes, 1/8" from case for 5 seconds | 300          | $^{\circ}\text{C}$ |

#### Notes:

1.  $V_{CC} = 400\text{ V}$ ,  $V_{GE} = 15\text{ V}$ ,  $I_C = 120\text{ A}$ ,  $R_G = 30\ \Omega$ , Inductive Load
2. Repetitive rating: Pulse width limited by max. junction temperature

FGA40T65SHDF — 650 V, 40 A Field Stop Trench IGBT

## Thermal Characteristics

| Symbol                  | Parameter                                     | FGA40T65SHDF | Unit                        |
|-------------------------|---|--------------|-----------------------------|
| $R_{\theta JC}$ (IGBT)  | Thermal Resistance, Junction to Case, Max.    | 0.56         | $^{\circ}\text{C}/\text{W}$ |
| $R_{\theta JC}$ (Diode) | Thermal Resistance, Junction to Case, Max.    | 1.75         | $^{\circ}\text{C}/\text{W}$ |
| $R_{\theta JA}$         | Thermal Resistance, Junction to Ambient, Max. | 40           | $^{\circ}\text{C}/\text{W}$ |

## Package Marking and Ordering Information

| Part Number  | Top Mark     | Package | Packing Method | Reel Size | Tape Width | Quantity |
|--------------|--------------|---------|----------------|-----------|------------|----------|
| FGA40T65SHDF | FGA40T65SHDF | TO-3PN  | Tube           | -         | -          | 30       |

## Electrical Characteristics of the IGBT $T_C = 25^{\circ}\text{C}$ unless otherwise noted

| Symbol                           | Parameter                                    | Test Conditions   | Min. | Typ. | Max.      | Unit                        |
|----------------------------------|--|---|------|------|-----------|-----------------------------|
| <b>Off Characteristics</b>       |  |   |      |      |           |                             |
| $BV_{CES}$                       | Collector to Emitter Breakdown Voltage       | $V_{GE} = 0\text{ V}, I_C = 1\text{ mA}$  | 650  | -    | -         | V                           |
| $\Delta BV_{CES}/\Delta T_J$     | Temperature Coefficient of Breakdown Voltage | $V_{GE} = 0\text{ V}, I_C = 1\text{ mA}$  | -    | 0.6  | -         | $\text{V}/^{\circ}\text{C}$ |
| $I_{CES}$                        | Collector Cut-Off Current                    | $V_{CE} = V_{CES}, V_{GE} = 0\text{ V}$   | -    | -    | 250       | $\mu\text{A}$               |
| $I_{GES}$                        | G-E Leakage Current                          | $V_{GE} = V_{GES}, V_{CE} = 0\text{ V}$   | -    | -    | $\pm 400$ | nA                          |
| <b>On Characteristics</b>        |  |   |      |      |           |                             |
| $V_{GE(th)}$                     | G-E Threshold Voltage                        | $I_C = 40\text{ mA}, V_{CE} = V_{GE}$   | 4.0  | 5.5  | 7.5       | V                           |
| $V_{CE(sat)}$                    | Collector to Emitter Saturation Voltage      | $I_C = 40\text{ A}, V_{GE} = 15\text{ V}$   | -    | 1.45 | 1.81      | V                           |
|                                  |  | $I_C = 40\text{ A}, V_{GE} = 15\text{ V}, T_C = 175^{\circ}\text{C}$  | -    | 1.8  | -         | V                           |
| <b>Dynamic Characteristics</b>   |  |   |      |      |           |                             |
| $C_{ies}$                        | Input Capacitance                            | $V_{CE} = 30\text{ V}, V_{GE} = 0\text{ V}, f = 1\text{ MHz}$   | -    | 1982 | -         | pF                          |
| $C_{oes}$                        | Output Capacitance                           |   | -    | 70   | -         | pF                          |
| $C_{res}$                        | Reverse Transfer Capacitance                 |   | -    | 25   | -         | pF                          |
| <b>Switching Characteristics</b> |  |   |      |      |           |                             |
| $T_{d(on)}$                      | Turn-On Delay Time                           | $V_{CC} = 400\text{ V}, I_C = 40\text{ A}, R_G = 6\ \Omega, V_{GE} = 15\text{ V}, \text{Inductive Load}, T_C = 25^{\circ}\text{C}$  | -    | 18   | -         | ns                          |
| $T_r$                            | Rise Time                                    |   | -    | 27   | -         | ns                          |
| $T_{d(off)}$                     | Turn-Off Delay Time                          |   | -    | 64   | -         | ns                          |
| $T_f$                            | Fall Time                                    |   | -    | 3    | -         | ns                          |
| $E_{on}$                         | Turn-On Switching Loss                       |   | -    | 1.22 | -         | mJ                          |
| $E_{off}$                        | Turn-Off Switching Loss                      |   | -    | 0.44 | -         | mJ                          |
| $E_{ts}$                         | Total Switching Loss                         |   | -    | 1.66 | -         | mJ                          |
| $T_{d(on)}$                      | Turn-On Delay Time                           | $V_{CC} = 400\text{ V}, I_C = 40\text{ A}, R_G = 6\ \Omega, V_{GE} = 15\text{ V}, \text{Inductive Load}, T_C = 175^{\circ}\text{C}$ | -    | 18   | -         | ns                          |
| $T_r$                            | Rise Time                                    |   | -    | 31   | -         | ns                          |
| $T_{d(off)}$                     | Turn-Off Delay Time                          |   | -    | 70   | -         | ns                          |
| $T_f$                            | Fall Time                                    |   | -    | 56   | -         | ns                          |
| $E_{on}$                         | Turn-On Switching Loss                       |   | -    | 1.78 | -         | mJ                          |
| $E_{off}$                        | Turn-Off Switching Loss                      |   | -    | 0.78 | -         | mJ                          |
| $E_{ts}$                         | Total Switching Loss                         |   | -    | 2.56 | -         | mJ                          |

**Electrical Characteristics of the IGBT** (Continued)

| Symbol   | Parameter                | Test Conditions   | Min. | Typ. | Max. | Unit |
|----------|--------------------------|---|------|------|------|------|
| $Q_g$    | Total Gate Charge        | $V_{CE} = 400\text{ V}$ , $I_C = 40\text{ A}$ ,<br>$V_{GE} = 15\text{ V}$ | -    | 68   | -    | nC   |
| $Q_{ge}$ | Gate to Emitter Charge   |   | -    | 12   | -    | nC   |
| $Q_{gc}$ | Gate to Collector Charge |   | -    | 25   | -    | nC   |

**Electrical Characteristics of the Diode**  $T_C = 25^\circ\text{C}$  unless otherwise noted

| Symbol    | Parameter                     | Test Conditions  | Min.                      | Typ. | Max. | Unit |               |
|-----------|-------------------------------|--|---------------------------|------|------|------|---------------|
| $V_{FM}$  | Diode Forward Voltage         | $I_F = 20\text{ A}$  | $T_C = 25^\circ\text{C}$  | -    | 1.5  | 1.95 | V             |
|           |                               |  | $T_C = 175^\circ\text{C}$ | -    | 1.37 | -    |               |
| $E_{rec}$ | Reverse Recovery Energy       | $I_F = 20\text{ A}$ , $di_F/dt = 200\text{ A}/\mu\text{s}$ | $T_C = 175^\circ\text{C}$ | -    | 153  | -    | $\mu\text{J}$ |
| $T_{rr}$  | Diode Reverse Recovery Time   |  | $T_C = 25^\circ\text{C}$  | -    | 101  | -    | ns            |
|           |                               |  | $T_C = 175^\circ\text{C}$ | -    | 238  | -    |               |
| $Q_{rr}$  | Diode Reverse Recovery Charge |  | $T_C = 25^\circ\text{C}$  | -    | 343  | -    | nC            |
|           |                               | $T_C = 175^\circ\text{C}$                                  | -                         | 1493 | -    |      |               |

## Typical Performance Characteristics

Figure 1. Typical Output Characteristics

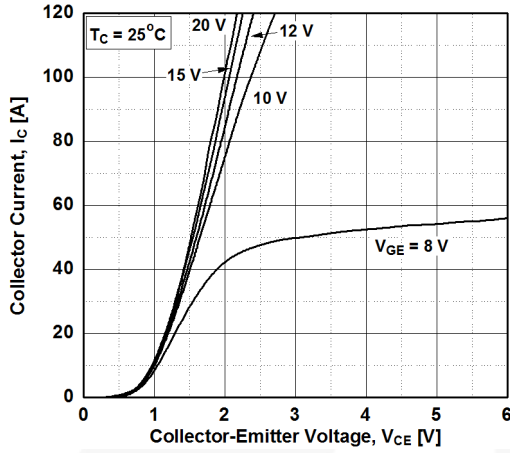


Figure 2. Typical Output Characteristics

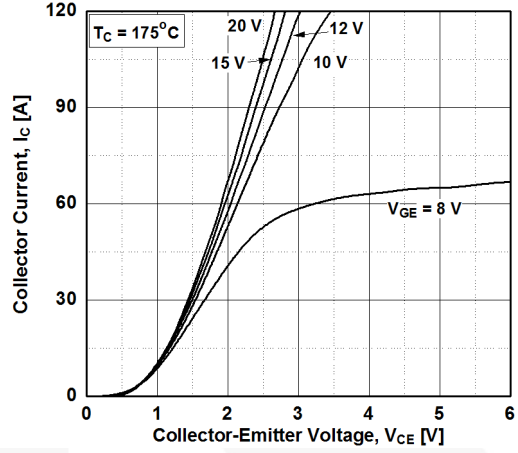


Figure 3. Typical Saturation Voltage Characteristics

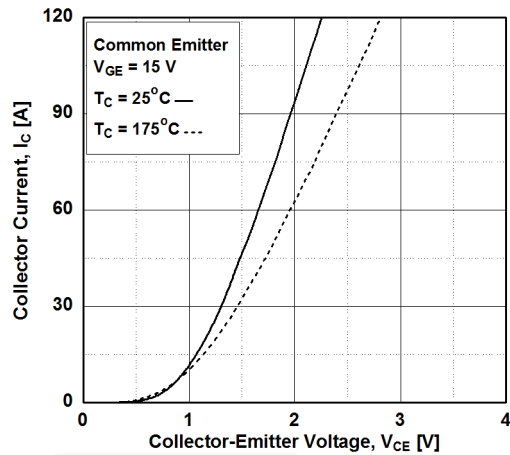


Figure 4. Saturation Voltage vs. Case Temperature at Variant Current Level

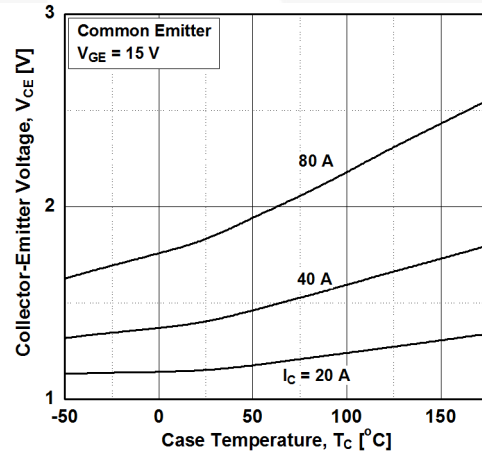


Figure 5. Saturation Voltage vs. VGE

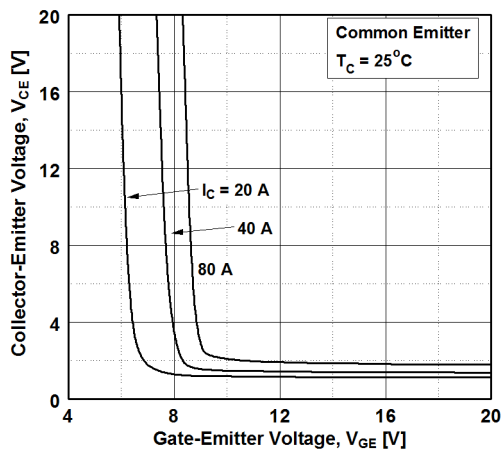
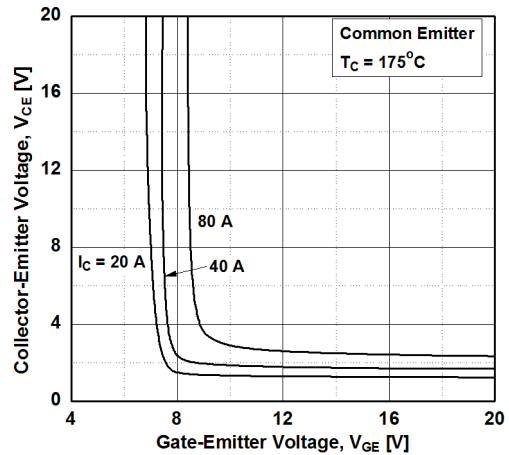
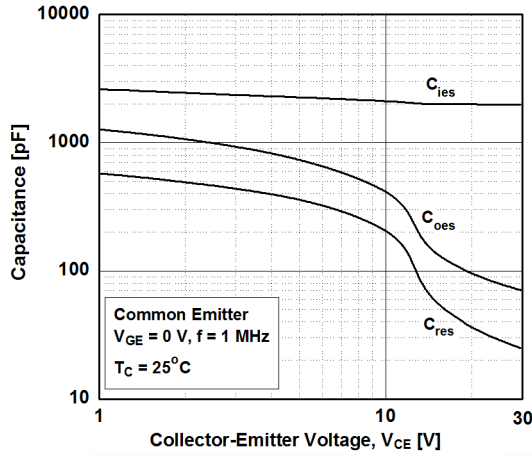


Figure 6. Saturation Voltage vs. VGE

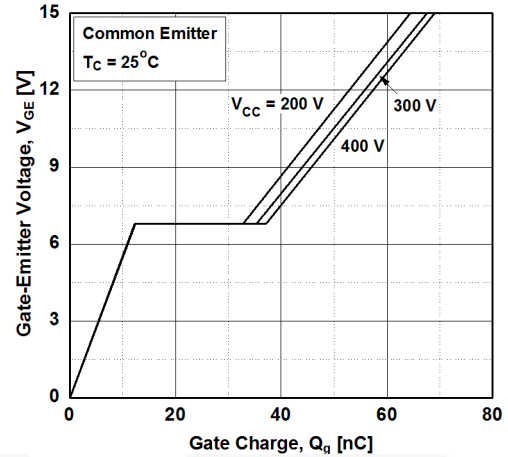


## Typical Performance Characteristics

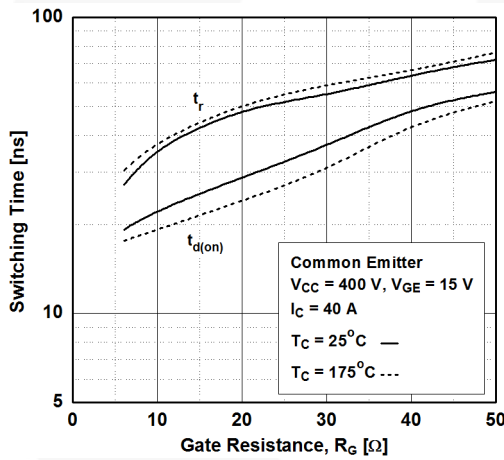
**Figure 7. Capacitance Characteristics**



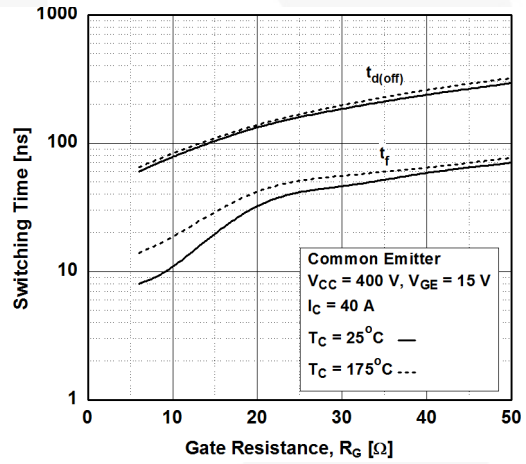
**Figure 8. Gate charge Characteristics**



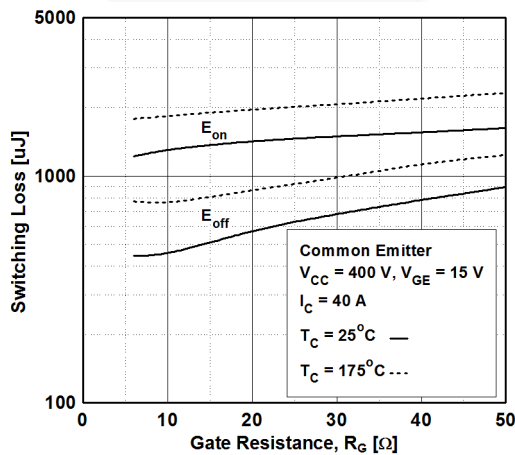
**Figure 9. Turn-on Characteristics vs. Gate Resistance**



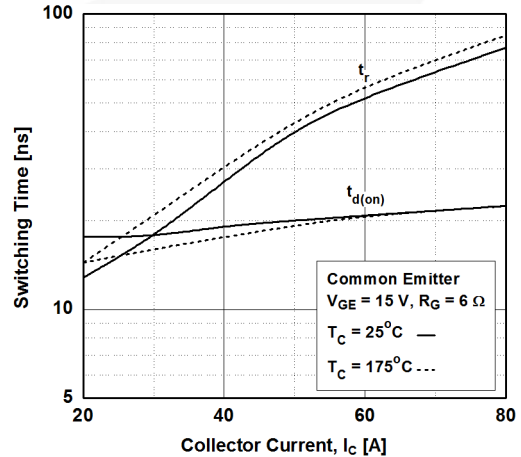
**Figure 10. Turn-off Characteristics vs. Gate Resistance**



**Figure 11. Switching Loss vs. Gate Resistance**

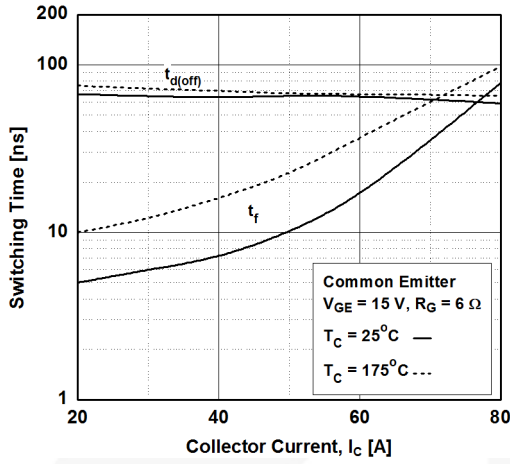


**Figure 12. Turn-on Characteristics vs. Collector Current**

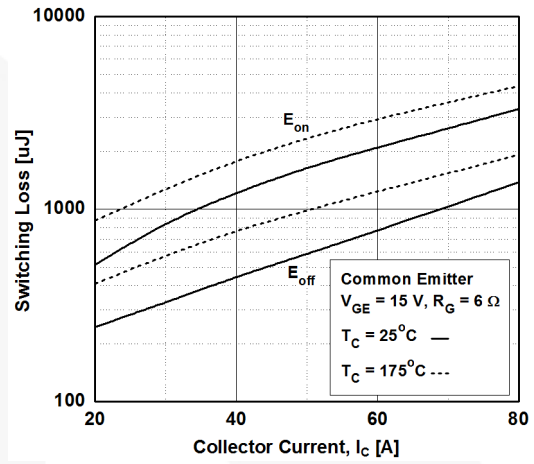


## Typical Performance Characteristics

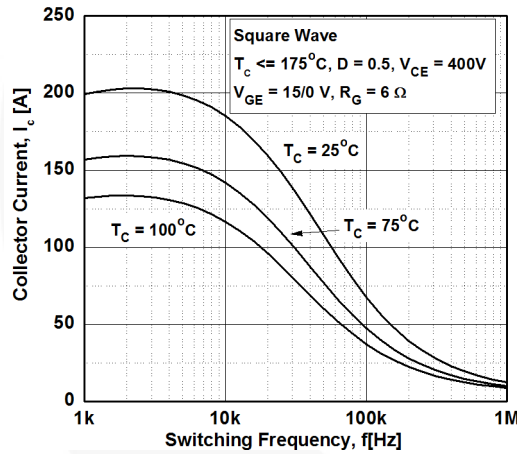
**Figure 13. Turn-off Characteristics vs. Collector Current**



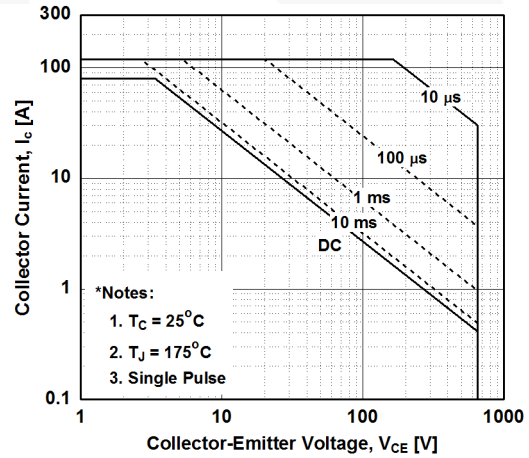
**Figure 14. Switching Loss vs. Collector Current**



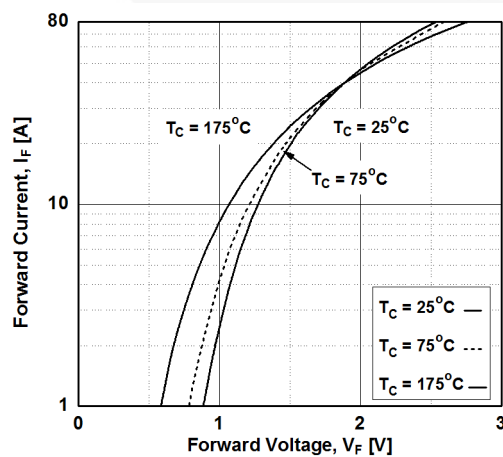
**Figure 15. Load Current Vs. Frequency**



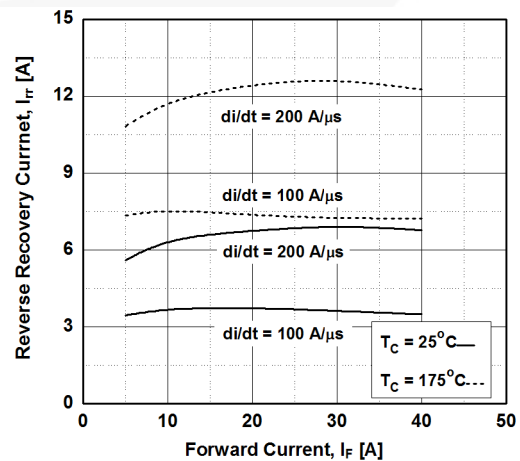
**Figure 16. SOA Characteristics**



**Figure 17. Forward Characteristics**



**Figure 18. Reverse Recovery Current**



## Typical Performance Characteristics

Figure 19. Reverse Recovery Time

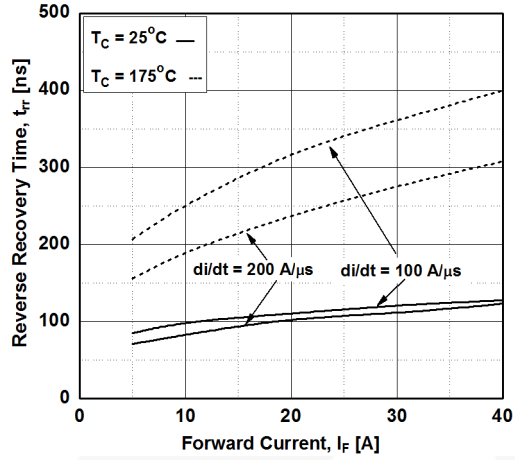


Figure 20. Stored Charge

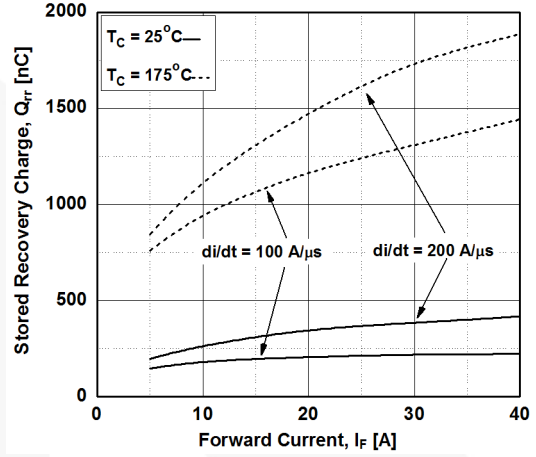


Figure 21. Transient Thermal Impedance of IGBT

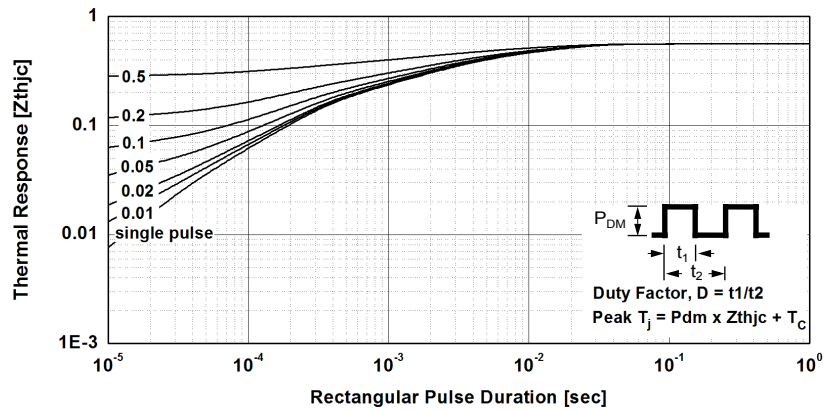
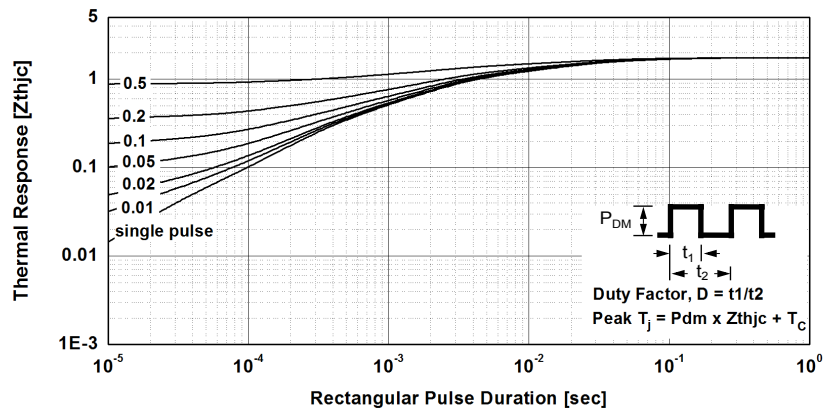


Figure 22. Transient Thermal Impedance of Diode









**TRADEMARKS**

The following includes registered and unregistered trademarks and service marks, owned by Fairchild Semiconductor and/or its global subsidiaries, and is not intended to be an exhaustive list of all such trademarks.

- |                          |  |                                       |                  |
|--------------------------|--|---------------------------------------|------------------|
| AccuPower™               | F-PFS™   | OPTOPLANAR®                           | SYSTEM GENERAL®  |
| AttitudeEngine™          | FRFET®   | Power Supply WebDesigner™             | TinyBoost®       |
| Awinda®                  | Global Power Resource <sup>SM</sup>            | PowerTrench®                          | TinyBuck®        |
| AX-CAP®*                 | GreenBridge™                                   | PowerXS™                              | TinyCalc™        |
| BitSiC™                  | Green FPS™                                     | Programmable Active Droop™            | TinyLogic®       |
| Build it Now™            | Green FPS™ e-Series™                           | QFET®                                 | TINYOPTO™        |
| CorePLUS™                | Gmax™  | QS™                                   | TinyPower™       |
| CorePOWER™               | GTO™   | Quiet Series™                         | TinyPWM™         |
| CROSSVOLT™               | IntelliMAX™                                    | RapidConfigure™                       | TinyWire™        |
| CTL™                     | ISOPLANAR™                                     | Saving our world, 1mW/W/kW at a time™ | TranSiC™         |
| Current Transfer Logic™  | Making Small Speakers Sound Louder and Better™ | SignalWise™                           | TriFault Detect™ |
| DEUXPEED®                | MegaBuck™                                      | SmartMax™                             | TRUECURRENT®*    |
| Dual Cool™               | MICROCOUPLER™                                  | SMART START™                          | μSerDes™         |
| EcoSPARK®                | MicroFET™                                      | Solutions for Your Success™           | UHC®             |
| EfficientMax™            | MicroPak™                                      | SPM®                                  | Ultra FRFET™     |
| ESBC™                    | MicroPak2™                                     | STEALTH™                              | UniFET™          |
| F <sup>®</sup>           | MillerDrive™                                   | SuperFET®                             | VCX™             |
| Fairchild®               | MotionMax™                                     | SuperSOT™-3                           | VisualMax™       |
| Fairchild Semiconductor® | MotionGrid®                                    | SuperSOT™-6                           | VoltagePlus™     |
| FACT Quiet Series™       | MTi®   | SuperSOT™-8                           | XST™             |
| FACT®                    | MTx®   | SupreMOS®                             | Xsens™           |
| FastvCore™               | MVN®   | SyncFET™                              | 仙童®              |
| FETBench™                | mWSaver®                                       | Sync-Lock™                            |                  |
| FPS™                     | OptoHiT™                                       |                                       |                  |
|                          | OPTOLOGIC®                                     |                                       |                  |

\* Trademarks of System General Corporation, used under license by Fairchild Semiconductor.

**DISCLAIMER**

FAIRCHILD SEMICONDUCTOR RESERVES THE RIGHT TO MAKE CHANGES WITHOUT FURTHER NOTICE TO ANY PRODUCTS HEREIN TO IMPROVE RELIABILITY, FUNCTION, OR DESIGN. TO OBTAIN THE LATEST, MOST UP-TO-DATE DATASHEET AND PRODUCT INFORMATION, VISIT OUR WEBSITE AT [HTTP://WWW.FAIRCHILDSEMI.COM](http://www.fairchildsemi.com). FAIRCHILD DOES NOT ASSUME ANY LIABILITY ARISING OUT OF THE APPLICATION OR USE OF ANY PRODUCT OR CIRCUIT DESCRIBED HEREIN; NEITHER DOES IT CONVEY ANY LICENSE UNDER ITS PATENT RIGHTS, NOR THE RIGHTS OF OTHERS. THESE SPECIFICATIONS DO NOT EXPAND THE TERMS OF FAIRCHILD'S WORLDWIDE TERMS AND CONDITIONS, SPECIFICALLY THE WARRANTY THEREIN, WHICH COVERS THESE PRODUCTS.

**AUTHORIZED USE**

Unless otherwise specified in this data sheet, this product is a standard commercial product and is not intended for use in applications that require extraordinary levels of quality and reliability. This product may not be used in the following applications, unless specifically approved in writing by a Fairchild officer: (1) automotive or other transportation, (2) military/aerospace, (3) any safety critical application – including life critical medical equipment – where the failure of the Fairchild product reasonably would be expected to result in personal injury, death or property damage. Customer's use of this product is subject to agreement of this Authorized Use policy. In the event of an unauthorized use of Fairchild's product, Fairchild accepts no liability in the event of product failure. In other respects, this product shall be subject to Fairchild's Worldwide Terms and Conditions of Sale, unless a separate agreement has been signed by both Parties.

**ANTI-COUNTERFEITING POLICY**

Fairchild Semiconductor Corporation's Anti-Counterfeiting Policy. Fairchild's Anti-Counterfeiting Policy is also stated on our external website, [www.fairchildsemi.com](http://www.fairchildsemi.com), under Terms of Use

Counterfeiting of semiconductor parts is a growing problem in the industry. All manufacturers of semiconductor products are experiencing counterfeiting of their parts. Customers who inadvertently purchase counterfeit parts experience many problems such as loss of brand reputation, substandard performance, failed applications, and increased cost of production and manufacturing delays. Fairchild is taking strong measures to protect ourselves and our customers from the proliferation of counterfeit parts. Fairchild strongly encourages customers to purchase Fairchild parts either directly from Fairchild or from Authorized Fairchild Distributors who are listed by country on our web page cited above. Products customers buy either from Fairchild directly or from Authorized Fairchild Distributors are genuine parts, have full traceability, meet Fairchild's quality standards for handling and storage and provide access to Fairchild's full range of up-to-date technical and product information. Fairchild and our Authorized Distributors will stand behind all warranties and will appropriately address any warranty issues that may arise. Fairchild will not provide any warranty coverage or other assistance for parts bought from Unauthorized Sources. Fairchild is committed to combat this global problem and encourage our customers to do their part in stopping this practice by buying direct or from authorized distributors.

**PRODUCT STATUS DEFINITIONS**

**Definition of Terms**

| Datasheet Identification | Product Status        | Definition  |
|--------------------------|-----------------------|---|
| Advance Information      | Formative / In Design | Datasheet contains the design specifications for product development. Specifications may change in any manner without notice.   |
| Preliminary              | First Production      | Datasheet contains preliminary data; supplementary data will be published at a later date. Fairchild Semiconductor reserves the right to make changes at any time without notice to improve design. |
| No Identification Needed | Full Production       | Datasheet contains final specifications. Fairchild Semiconductor reserves the right to make changes at any time without notice to improve the design.   |
| Obsolete                 | Not In Production     | Datasheet contains specifications on a product that is discontinued by Fairchild Semiconductor. The datasheet is for reference information only.  |

Rev. I77

# Mouser Electronics

Authorized Distributor

Click to View Pricing, Inventory, Delivery & Lifecycle Information:

[Fairchild Semiconductor:](#)

[FGA40T65SHDF](#)