

# FGD4536

## 360 V PDP Trench IGBT

### Features

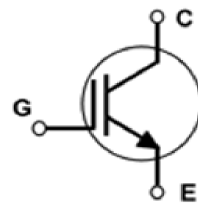
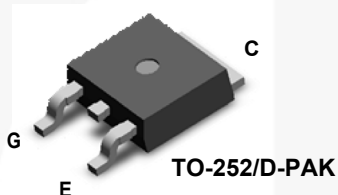
- High Current Capability
- Low Saturation Voltage:  $V_{CE(sat)} = 1.59 \text{ V @ } I_C = 50 \text{ A}$
- High Input Impedance
- Fast Switching
- RoHS Compliant

### Applications

- PDP TV, Consumer Appliances

### General Description

Using novel trench IGBT technology, Fairchild's new series of trench IGBTs offer the optimum performance for consumer appliances and PDP TV applications where low conduction and switching losses are essential.



### Absolute Maximum Ratings

| Symbol                  | Description   | Ratings     | Unit             |
|-------------------------|---|-------------|------------------|
| $V_{CES}$               | Collector to Emitter Voltage  | 360         | V                |
| $V_{GES}$               | Gate to Emitter Voltage   | $\pm 30$    | V                |
| $I_C \text{ pulse(1)*}$ | Pulsed Collector Current @ $T_C = 25^\circ\text{C}$                     | 220         | A                |
| $P_D$                   | Maximum Power Dissipation @ $T_C = 25^\circ\text{C}$                    | 125         | W                |
|                         | Maximum Power Dissipation @ $T_C = 100^\circ\text{C}$                   | 50          | W                |
| $T_J$                   | Operating Junction Temperature  | -55 to +150 | $^\circ\text{C}$ |
| $T_{stg}$               | Storage Temperature Range   | -55 to +150 | $^\circ\text{C}$ |
| $T_L$                   | Maximum Lead Temp. for soldering Purposes, 1/8" from case for 5 seconds | 300         | $^\circ\text{C}$ |

### Thermal Characteristics

| Symbol                       | Parameter                               | Typ. | Max. | Unit               |
|------------------------------|---|------|------|--------------------|
| $R_{\theta JC}(\text{IGBT})$ | Thermal Resistance, Junction to Case    | -    | 1.0  | $^\circ\text{C/W}$ |
| $R_{\theta JA}$              | Thermal Resistance, Junction to Ambient | -    | 62.5 | $^\circ\text{C/W}$ |

**Notes:**

(1) Half Sine Wave,  $D < 0.01$ , pulse width  $< 1 \mu\text{sec}$

\*  $I_{C\_pulse}$  limited by max  $T_J$

## Package Marking and Ordering Information

| Device Marking | Device         | Package      | Reel Size | Tape Width | Quantity |
|----------------|----------------|--------------|-----------|------------|----------|
| FGD4536        | FGD4536TM      | TO252(D-PAK) | 380 mm    | 16 mm      | -        |
| FGD4536        | FGD4536TM_F065 | TO252(D-PAK) | 380 mm    | 16 mm      | -        |

## Electrical Characteristics of the IGBT T<sub>C</sub> = 25°C unless otherwise noted

| Symbol                               | Parameter                                    | Test Conditions  | Min. | Typ. | Max. | Unit    |
|--------------------------------------|--|--|------|------|------|---------|
| <b>Off Characteristics</b>           |  |  |      |      |      |         |
| $BV_{CES}$                           | Collector to Emitter Breakdown Voltage       | $V_{GE} = 0V, I_C = 250 \mu A$   | 360  | -    | -    | V       |
| $\frac{\Delta BV_{CES}}{\Delta T_J}$ | Temperature Coefficient of Breakdown Voltage | $V_{GE} = 0V, I_C = 250 \mu A$   | -    | 0.4  | -    | V/°C    |
| $I_{CES}$                            | Collector Cut-Off Current                    | $V_{CE} = V_{CES}, V_{GE} = 0V$  | -    | -    | 100  | $\mu A$ |
| $I_{GES}$                            | G-E Leakage Current                          | $V_{GE} = V_{GES}, V_{CE} = 0V$  | -    | -    | ±400 | nA      |
| <b>On Characteristics</b>            |  |  |      |      |      |         |
| $V_{GE(th)}$                         | G-E Threshold Voltage                        | $I_C = 250 \mu A, V_{CE} = V_{GE}$   | 2.4  | 3.3  | 4.0  | V       |
| $V_{CE(sat)}$                        | Collector to Emitter Saturation Voltage      | $I_C = 20 A, V_{GE} = 15 V$  | -    | 1.19 | -    | V       |
|                                      |  | $I_C = 30 A, V_{GE} = 15 V$  | -    | 1.33 | -    | V       |
|                                      |  | $I_C = 50 A, V_{GE} = 15 V, T_C = 25^\circ C$  | -    | 1.59 | 1.8  | V       |
|                                      |  | $I_C = 50 A, V_{GE} = 15 V, T_C = 125^\circ C$   | -    | 1.66 | -    | V       |
| <b>Dynamic Characteristics</b>       |  |  |      |      |      |         |
| $C_{ies}$                            | Input Capacitance                            | $V_{CE} = 30 V, V_{GE} = 0 V, f = 1 MHz$   | -    | 1295 | -    | pF      |
| $C_{oes}$                            | Output Capacitance                           |  | -    | 56   | -    | pF      |
| $C_{res}$                            | Reverse Transfer Capacitance                 |  | -    | 43   | -    | pF      |
| <b>Switching Characteristics</b>     |  |  |      |      |      |         |
| $t_{d(on)}$                          | Turn-On Delay Time                           | $V_{CC} = 200 V, I_C = 20 A, R_G = 5 \Omega, V_{GE} = 15 V, Resistive Load, T_C = 25^\circ C$  | -    | 5    | -    | ns      |
| $t_r$                                | Rise Time                                    |  | -    | 20   | -    | ns      |
| $t_{d(off)}$                         | Turn-Off Delay Time                          |  | -    | 41   | -    | ns      |
| $t_f$                                | Fall Time                                    |  | -    | 182  | -    | ns      |
| $t_{d(on)}$                          | Turn-On Delay Time                           | $V_{CC} = 200 V, I_C = 20 A, R_G = 5 \Omega, V_{GE} = 15 V, Resistive Load, T_C = 125^\circ C$ | -    | 5    | -    | ns      |
| $t_r$                                | Rise Time                                    |  | -    | 21   | -    | ns      |
| $t_{d(off)}$                         | Turn-Off Delay Time                          |  | -    | 43   | -    | ns      |
| $t_f$                                | Fall Time                                    |  | -    | 249  | -    | ns      |
| $Q_g$                                | Total Gate Charge                            | $V_{CE} = 200 V, I_C = 20 A, V_{GE} = 15 V$  | -    | 47   | -    | nC      |
| $Q_{ge}$                             | Gate to Emitter Charge                       |  | -    | 5.4  | -    | nC      |
| $Q_{gc}$                             | Gate to Collector Charge                     |  | -    | 15   | -    | nC      |

## Typical Performance Characteristics

Figure 1. Typical Output Characteristics

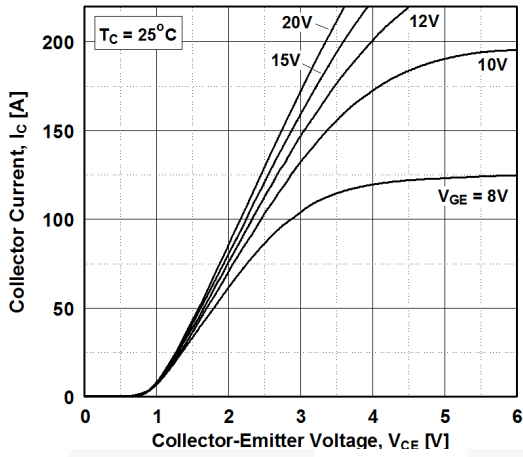


Figure 2. Typical Output Characteristics

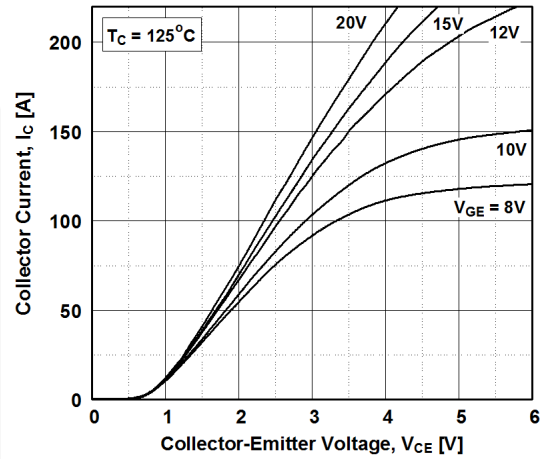


Figure 3. Typical Saturation Voltage Characteristics

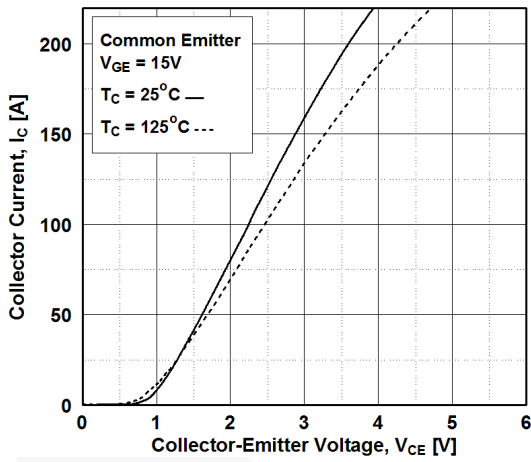


Figure 4. Transfer Characteristics

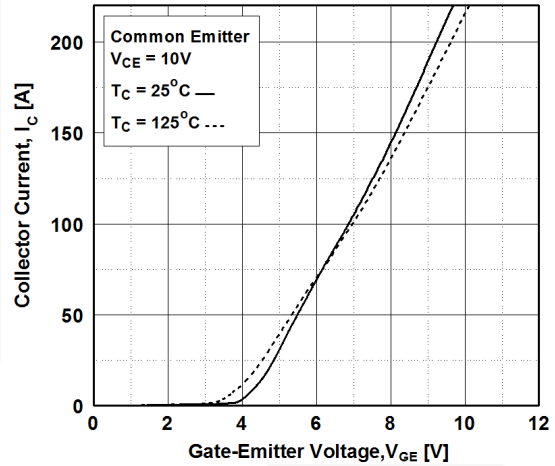


Figure 5. Saturation Voltage vs.  $V_{ge}$

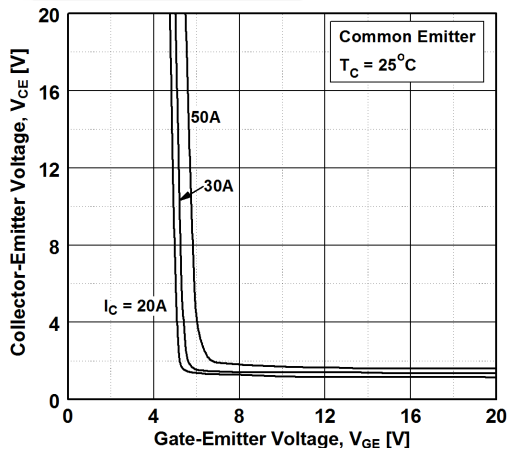
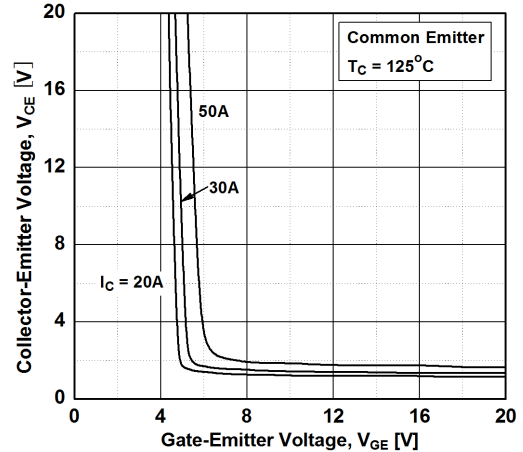
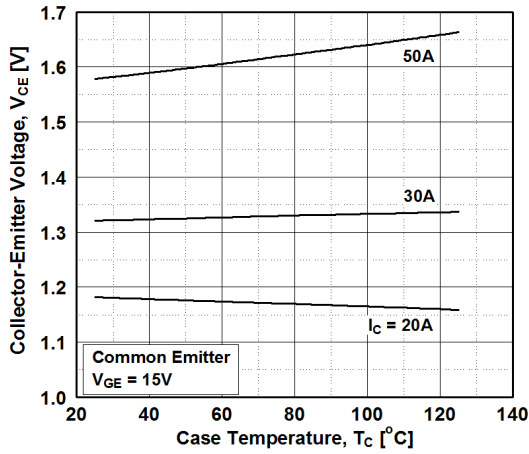


Figure 6. Saturation Voltage vs.  $V_{ge}$

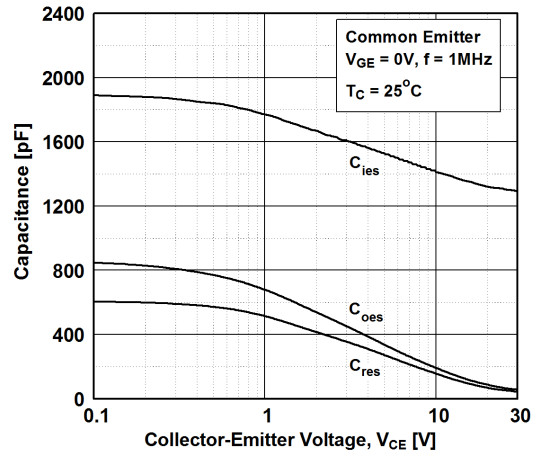


## Typical Performance Characteristics

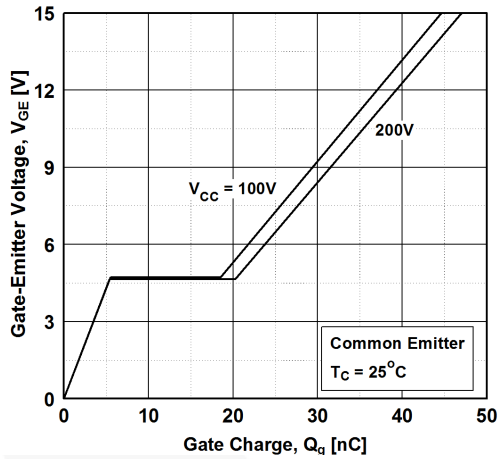
**Figure 7. Saturation Voltage vs. Case Temperature at Variant Current Level**



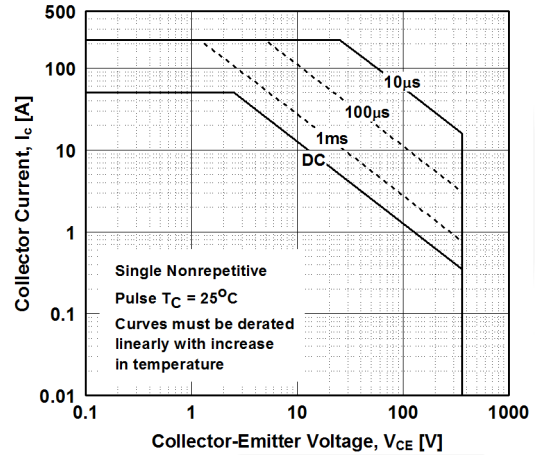
**Figure 8. Capacitance Characteristics**



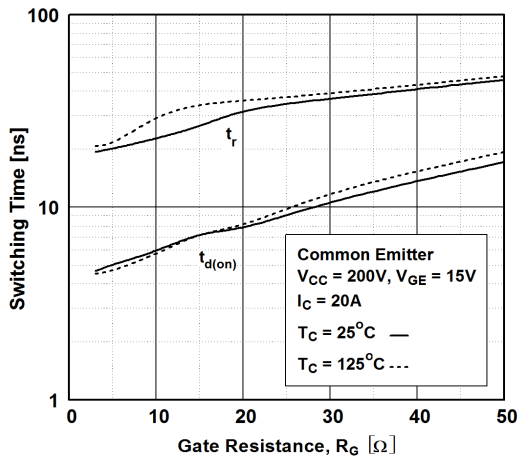
**Figure 9. Gate charge Characteristics**



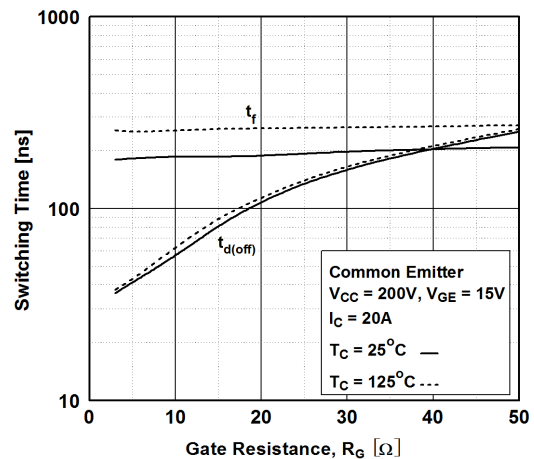
**Figure 10. SOA Characteristics**



**Figure 11. Turn-on Characteristics vs. Gate Resistance**

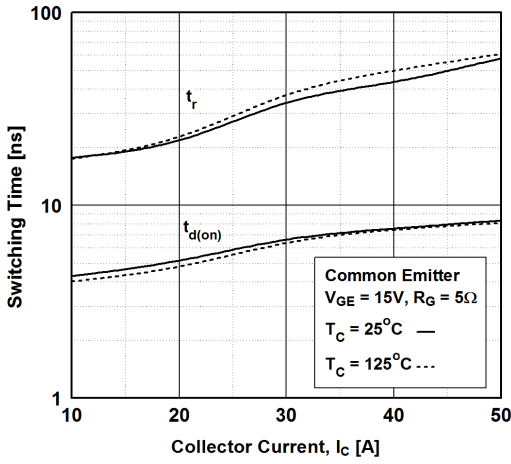


**Figure 12. Turn-off Characteristics vs. Gate Resistance**

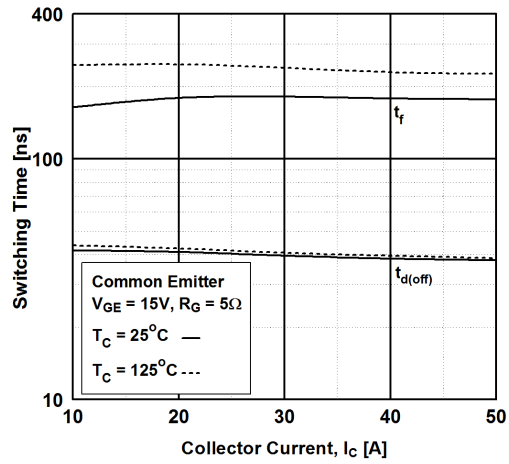


## Typical Performance Characteristics

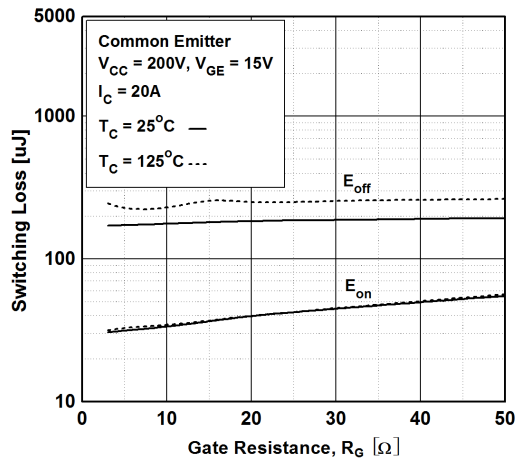
**Figure 13. Turn-on Characteristics vs. Collector Current**



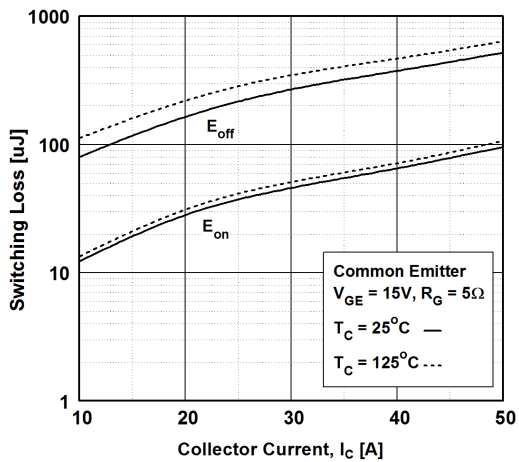
**Figure 14. Turn-off Characteristics vs. Collector Current**



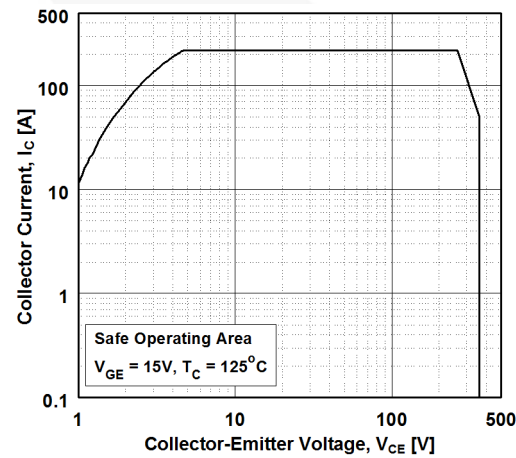
**Figure 15. Switching Loss vs. Gate Resistance**



**Figure 16. Switching Loss vs. Collector Current**

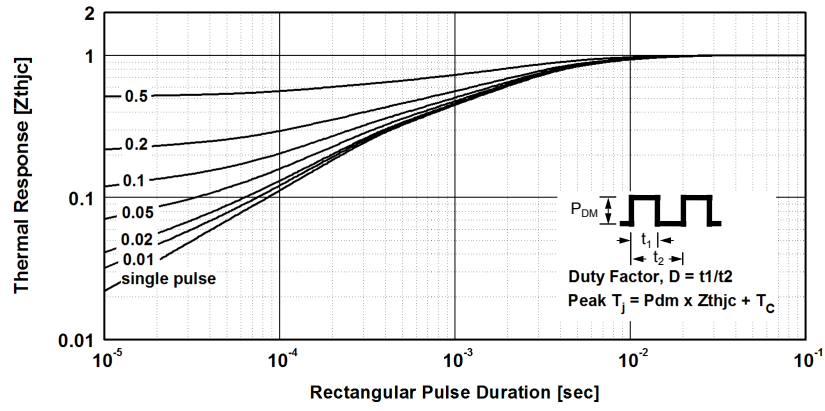


**Figure 17. Turn off Switching SOA Characteristics**

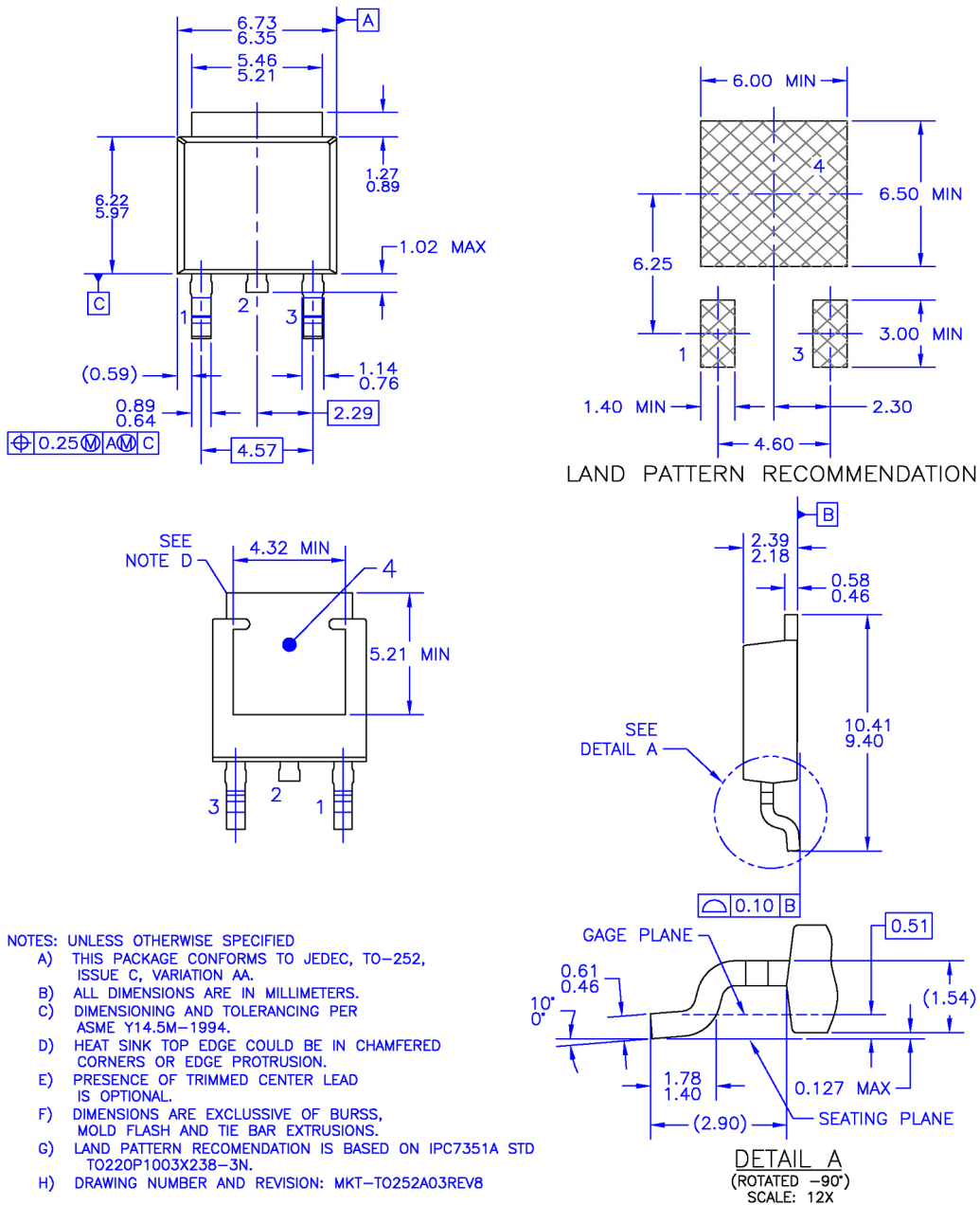


Typical Performance Characteristics

Figure 18. Transient Thermal Impedance of IGBT



### Mechanical Dimensions



**Figure 19. TO252 (D-PAK), MOLDED, 3 LEAD, OPTION AA&AB**

Package drawings are provided as a service to customers considering Fairchild components. Drawings may change in any manner without notice. Please note the revision and/or date on the drawing and contact a Fairchild Semiconductor representative to verify or obtain the most recent revision. Package specifications do not expand the terms of Fairchild's worldwide terms and conditions, specifically the warranty therein, which covers Fairchild products.

Always visit Fairchild Semiconductor's online packaging area for the most recent package drawings:

[http://www.fairchildsemi.com/package/packageDetails.html?id=PN\\_TT252-003](http://www.fairchildsemi.com/package/packageDetails.html?id=PN_TT252-003)

Dimensions in Millimeters





# Mouser Electronics

Authorized Distributor

Click to View Pricing, Inventory, Delivery & Lifecycle Information:

[Fairchild Semiconductor:](#)

[FGD4536TM](#)