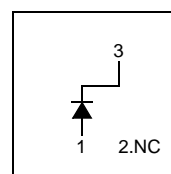
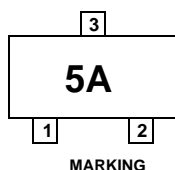
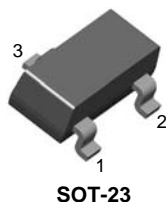


# MMBD6050

## Small Signal Diode



### Connection Diagram



### Absolute Maximum Ratings \* $T_A = 25^\circ\text{C}$ unless otherwise noted

Symbol	Parameter	Value	Units
$V_{RRM}$	Maximum Repetitive Reverse Voltage	70	V
$I_{F(AV)}$	Average Rectified Forward Current	200	mA
$I_{FSM}$	Non-repetitive Peak Forward Surge Current Pulse Width = 1.0 second Pulse Width = 1.0 microsecond	1.0	A
		2.0	A
$T_{STG}$	Storage Temperature Range	-55 to +150	$^\circ\text{C}$
$T_J$	Operating Junction Temperature	-55 to +150	$^\circ\text{C}$

\* These ratings are limiting values above which the serviceability of the diode may be impaired.

#### NOTES:

- 1) These ratings are based on a maximum junction temperature of 150 degrees C.
- 2) These are steady limits. The factory should be consulted on applications involving pulsed or low duty cycle operations.

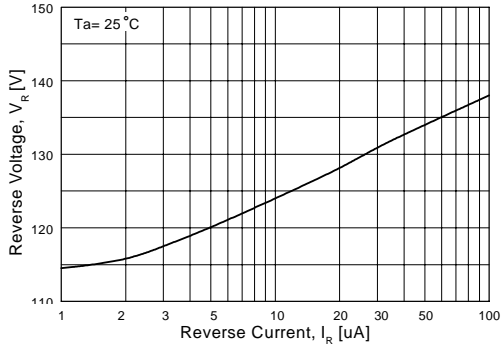
### Thermal Characteristics

Symbol	Parameter	Value	Units
$P_D$	Power Dissipation	350	mW
$R_{\theta JA}$	Thermal Resistance, Junction to Ambient	357	$^\circ\text{C/W}$

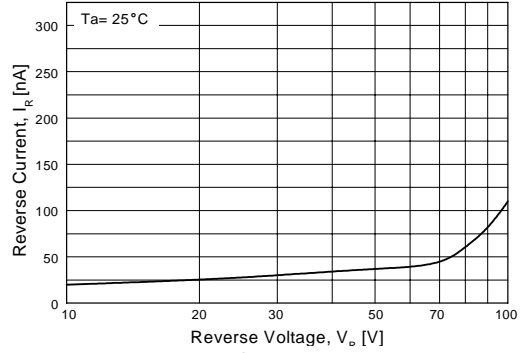
### Electrical Characteristics $T_A = 25^\circ\text{C}$ unless otherwise noted

Symbol	Parameter	Test Conditions	Min.	Max.	Units
$V_R$	Breakdown Voltage	$I_R = 100\mu\text{A}$	70		V
$V_F$	Forward Voltage	$I_F = 1\text{mA}$	0.55	0.7	V
		$I_F = 100\text{mA}$	0.85	1.1	
$I_R$	Reverse Leakage	$V_R = 50\text{V}$		100	nA
$C_T$	Total Capacitance	$V_R = 0\text{V}, f = 1.0\text{MHz}$		2.5	pF
$t_{rr}$	Reverse Recovery Time	$I_F = I_R = 10\text{mA},$ $I_{RR} = 1.0\text{mA}, R_L = 100\Omega$		4.0	ns

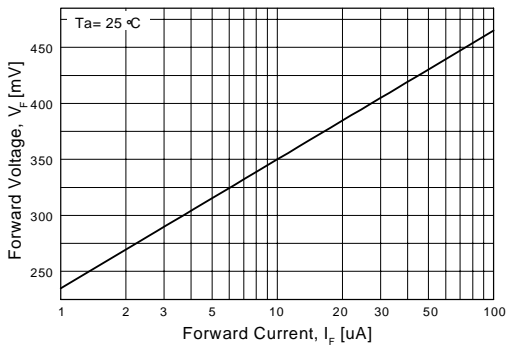
## Typical Performance Characteristics



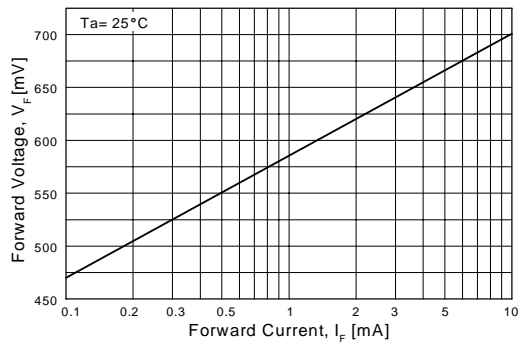
**Figure 1. Reverse Voltage vs Reverse Current  
BV - 1.0 to 100uA**



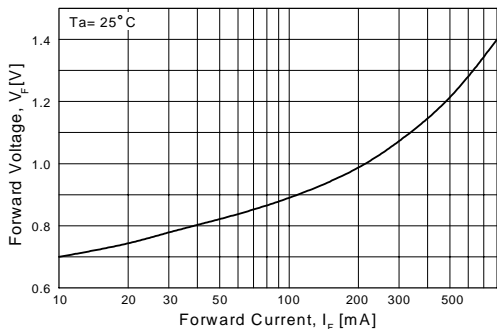
**Figure 2. Reverse Current vs Reverse Voltage  
IR - 10 to 100 V**



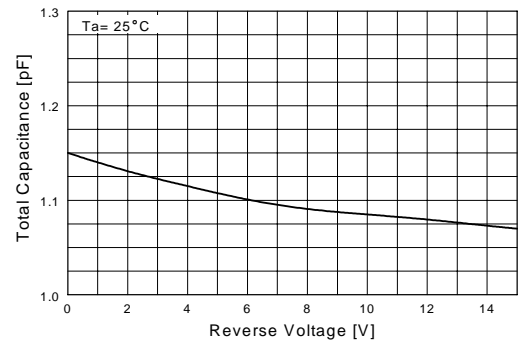
**Figure 3. Forward Voltage vs Forward Current  
VF - 1.0 to 100 uA**



**Figure 4. Forward Voltage vs Forward Current  
VF - 0.1 to 10 mA**

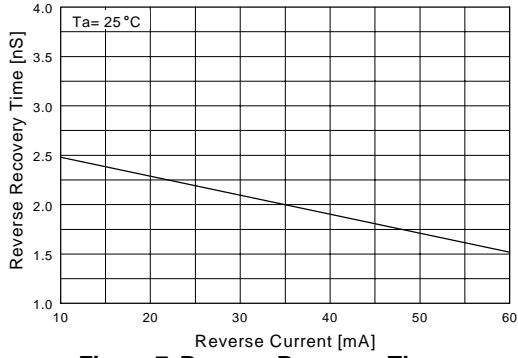


**Figure 5. Forward Voltage vs Forward Current  
VF - 10 - 800 mA**

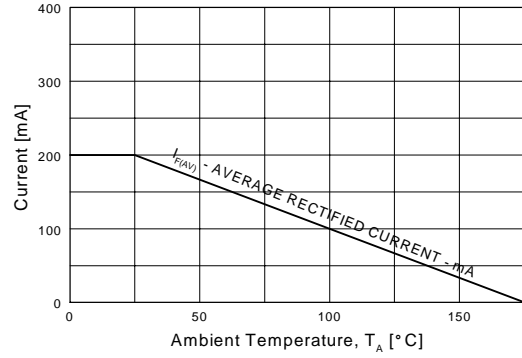


**Figure 6. Total Capacitance vs Reverse Voltage**

Typical Performance Characteristics (Continued)



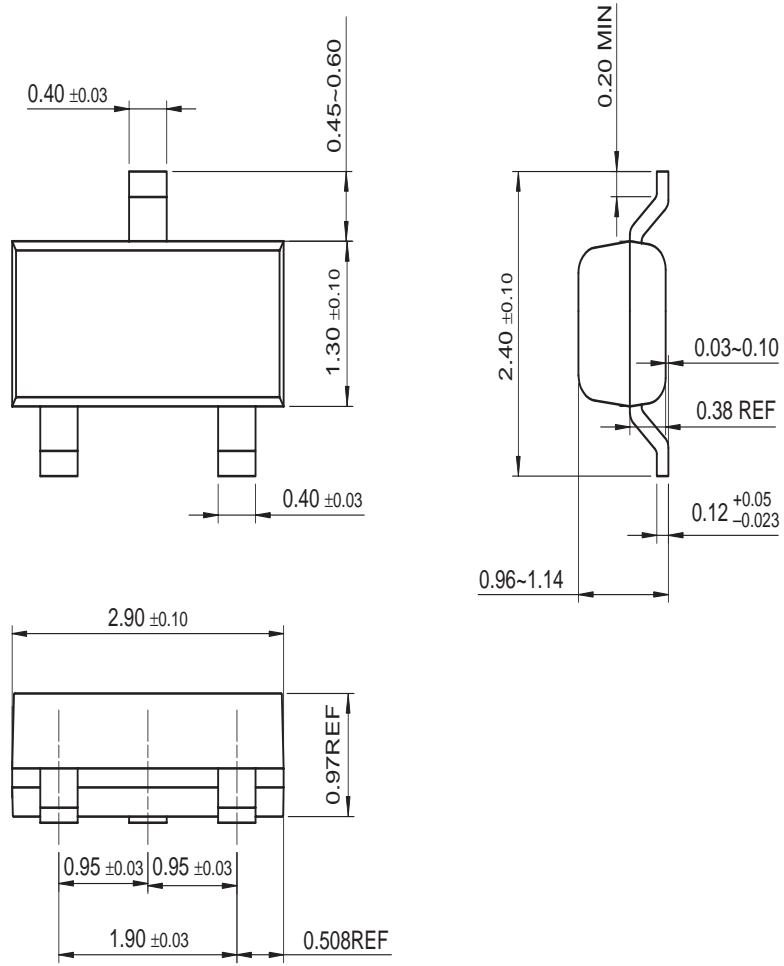
**Figure 7. Reverse Recovery Time vs Reverse Current**  
TRR - IR 10 mA vs 60 mA



**Figure 8. Average Rectified Current ( $I_{F(AV)}$ ) versus Ambient Temperature ( $T_A$ )**

Mechanical Dimensions

SOT-23





## TRADEMARKS

The following are registered and unregistered trademarks Fairchild Semiconductor owns or is authorized to use and is not intended to be an exhaustive list of all such trademarks.

ACEx™	GTO™	PowerSaver™	TinyBuck™
Across the board. Around the world.™	HiSeC™	PowerTrench®	TinyLogic®
ActiveArray™	<i>i-Lo</i> ™	Programmable Active Droop™	TINYOPTO™
Bottomless™	ImpliedDisconnect™	QFET®	TinyPower™
Build it Now™	IntelliMAX™	QST™	TinyWire™
CoolFET™	ISOPLANAR™	QT Optoelectronics™	TruTranslation™
CROSSVOLT™	MICROCOUPLER™	Quiet Series™	μSerDes™
CTL™	MicroPak™	RapidConfigure™	UHC®
<i>Current Transfer Logic</i> ™	MICROWIRE™	RapidConnect™	UniFET™
DOMET™	MSX™	ScalarPump™	VCX™
E <sup>2</sup> CMOS™	MSXPro™	SMART START™	Wire™
EcoSPARK®	OCX™	SPM™	
EnSigna™	OCXPro™	SuperFET™	
FACT Quiet Series™	OPTOLOGIC®	SuperSOT™-3	
FACT®	OPTOPLANAR™®	SuperSOT™-6	
FAST®	PACMAN™	SuperSOT™-8	
FASTr™	POP™	TCM™	
FPS™	Power220®	The Power Franchise®	
FRFET™	Power247®	TinyBoost™	
GlobalOptoisolator™	PowerEdge™		

## DISCLAIMER

FAIRCHILD SEMICONDUCTOR RESERVES THE RIGHT TO MAKE CHANGES WITHOUT FURTHER NOTICE TO ANY PRODUCTS HEREIN TO IMPROVE RELIABILITY, FUNCTION OR DESIGN. FAIRCHILD DOES NOT ASSUME ANY LIABILITY ARISING OUT OF THE APPLICATION OR USE OF ANY PRODUCT OR CIRCUIT DESCRIBED HEREIN; NEITHER DOES IT CONVEY ANY LICENSE UNDER ITS PATENT RIGHTS, NOR THE RIGHTS OF OTHERS. THESE SPECIFICATIONS DO NOT EXPAND THE TERMS OF FAIRCHILD'S WORLDWIDE TERMS AND CONDITIONS, SPECIFICALLY THE WARRANTY THEREIN, WHICH COVERS THESE PRODUCTS.

## LIFE SUPPORT POLICY

FAIRCHILD'S PRODUCTS ARE NOT AUTHORIZED FOR USE AS CRITICAL COMPONENTS IN LIFE SUPPORT DEVICES OR SYSTEMS WITHOUT THE EXPRESS WRITTEN APPROVAL OF FAIRCHILD SEMICONDUCTOR CORPORATION.

As used herein:

1. Life support devices or systems are devices or systems which, (a) are intended for surgical implant into the body, or (b) support or sustain life, or (c) whose failure to perform when properly used in accordance with instructions for use provided in the labeling, can be reasonably expected to result in significant injury to the user.
2. A critical component is any component of a life support device or system whose failure to perform can be reasonably expected to cause the failure of the life support device or system, or to affect its safety or effectiveness.

## PRODUCT STATUS DEFINITIONS

### Definition of Terms

Datasheet Identification	Product Status	Definition
Advance Information	Formative or In Design	This datasheet contains the design specifications for product development. Specifications may change in any manner without notice.
Preliminary	First Production	This datasheet contains preliminary data, and supplementary data will be published at a later date. Fairchild Semiconductor reserves the right to make changes at any time without notice in order to improve design.
No Identification Needed	Full Production	This datasheet contains final specifications. Fairchild Semiconductor reserves the right to make changes at any time without notice in order to improve design.
Obsolete	Not In Production	This datasheet contains specifications on a product that has been discontinued by Fairchild semiconductor. The datasheet is printed for reference information only.

Rev. I23

# Mouser Electronics

Authorized Distributor

Click to View Pricing, Inventory, Delivery & Lifecycle Information:

[Fairchild Semiconductor:](#)

[MMBD6050](#)