

**IRF6710S2TRPbF**  
**IRF6710S2TR1PbF**

DirectFET™ Power MOSFET ②

- RoHS Compliant Containing No Lead and Halogen Free ①
- Low Profile (<0.7 mm)
- Dual Sided Cooling Compatible ①
- Ultra Low Package Inductance
- Optimized for High Frequency Switching ①
- Ideal for CPU Core DC-DC Converters
- Optimized for Control FET Application①
- Compatible with existing Surface Mount Techniques ①
- 100% Rg tested

Typical values (unless otherwise specified)

V <sub>DSS</sub>		V <sub>GS</sub>		R <sub>DS(on)</sub>		R <sub>DS(on)</sub>	
25V max		±20V max		4.5mΩ@ 10V		9.0mΩ@ 4.5V	
Q <sub>g tot</sub>	Q <sub>gd</sub>	Q <sub>gs2</sub>	Q <sub>rr</sub>	Q <sub>oss</sub>	V <sub>gs(th)</sub>		
8.8nC	3.0nC	1.3nC	8.0nC	4.4nC	1.8V		

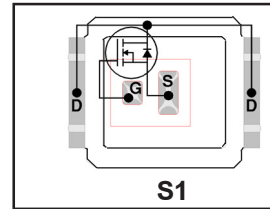

Applicable DirectFET Outline and Substrate Outline ①

<b>S1</b>	S2	SB		M2	M4		L4	L6	L8	
-----------	----	----	--	----	----	--	----	----	----	--

**Description**

The IRF6710S2TRPbF combines the latest HEXFET® Power MOSFET Silicon technology with the advanced DirectFET™ packaging to achieve improved performance in a package that has the footprint of a MICRO-8 and only 0.7 mm profile. The DirectFET package is compatible with existing layout geometries used in power applications, PCB assembly equipment and vapor phase, infra-red or convection soldering techniques, when application note AN-1035 is followed regarding the manufacturing methods and processes. The DirectFET package allows dual sided cooling to maximize thermal transfer in power systems, improving previous best thermal resistance by 80%.

The IRF6710S2TRPbF has low gate resistance and low charge along with ultra low package inductance providing significant reduction in switching losses. The reduced losses make this product ideal for high efficiency DC-DC converters that power the latest generation of processors operating at higher frequencies. The IRF6710S2TRPbF has been optimized for the control FET socket of synchronous buck operating from 12 volt bus converters.

**Absolute Maximum Ratings**

	Parameter	Max.	Units
V <sub>DS</sub>	Drain-to-Source Voltage	25	V
V <sub>GS</sub>	Gate-to-Source Voltage	±20	
I <sub>D</sub> @ T <sub>A</sub> = 25°C	Continuous Drain Current, V <sub>GS</sub> @ 10V ③	12	A
I <sub>D</sub> @ T <sub>A</sub> = 70°C	Continuous Drain Current, V <sub>GS</sub> @ 10V ③	10	
I <sub>D</sub> @ T <sub>C</sub> = 25°C	Continuous Drain Current, V <sub>GS</sub> @ 10V ④	37	
I <sub>DM</sub>	Pulsed Drain Current ⑤	100	
E <sub>AS</sub>	Single Pulse Avalanche Energy ⑥	24	mJ
I <sub>AR</sub>	Avalanche Current ⑤	10	A

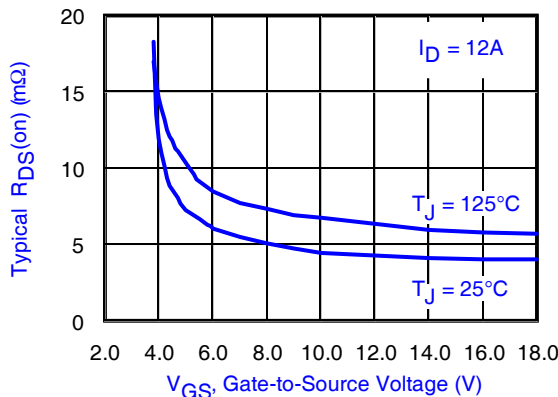

Fig 1. Typical On-Resistance vs. Gate Voltage

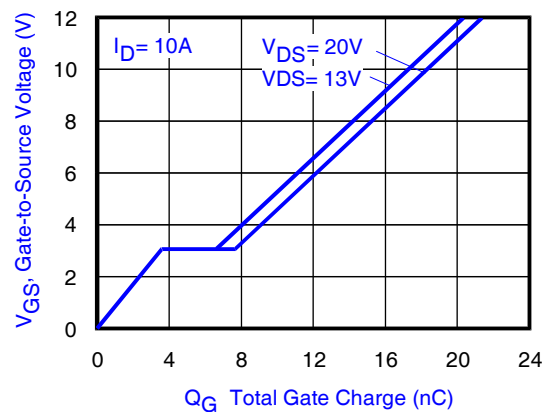

Fig 2. Typical Total Gate Charge vs. Gate-to-Source Voltage

Notes:

- ① Click on this section to link to the appropriate technical paper.
- ② Click on this section to link to the DirectFET Website.
- ③ Surface mounted on 1 in. square Cu board, steady state.

- ④ T<sub>C</sub> measured with thermocouple mounted to top (Drain) of part.
- ⑤ Repetitive rating; pulse width limited by max. junction temperature.
- ⑥ Starting T<sub>J</sub> = 25°C, L = 0.49mH, R<sub>G</sub> = 25Ω, I<sub>AS</sub> = 10A.

## Static @ $T_J = 25^\circ\text{C}$ (unless otherwise specified)

	Parameter	Min.	Typ.	Max.	Units	Conditions
$BV_{DSS}$	Drain-to-Source Breakdown Voltage	25	—	—	V	$V_{GS} = 0V, I_D = 250\mu A$
$\Delta BV_{DSS}/\Delta T_J$	Breakdown Voltage Temp. Coefficient	—	17	—	mV/°C	Reference to $25^\circ\text{C}, I_D = 1\text{mA}$
$R_{DS(on)}$	Static Drain-to-Source On-Resistance	—	4.5	5.9	mΩ	$V_{GS} = 10V, I_D = 12A$ ⑦
		—	9.0	11.9		$V_{GS} = 4.5V, I_D = 10A$ ⑦
$V_{GS(th)}$	Gate Threshold Voltage	1.4	1.8	2.4	V	$V_{DS} = V_{GS}, I_D = 25\mu A$
$\Delta V_{GS(th)}/\Delta T_J$	Gate Threshold Voltage Coefficient	—	-7.0	—	mV/°C	
$I_{DSS}$	Drain-to-Source Leakage Current	—	—	1.0	μA	$V_{DS} = 20V, V_{GS} = 0V$
		—	—	150		$V_{DS} = 20V, V_{GS} = 0V, T_J = 125^\circ\text{C}$
$I_{GSS}$	Gate-to-Source Forward Leakage	—	—	100	nA	$V_{GS} = 20V$
	Gate-to-Source Reverse Leakage	—	—	-100		$V_{GS} = -20V$
$g_{fs}$	Forward Transconductance	21	—	—	S	$V_{DS} = 15V, I_D = 10A$
$Q_g$	Total Gate Charge	—	8.8	13	nC	$V_{DS} = 13V$ $V_{GS} = 4.5V$ $I_D = 10A$ See Fig. 15
$Q_{gs1}$	Pre-Vth Gate-to-Source Charge	—	2.3	—		
$Q_{gs2}$	Post-Vth Gate-to-Source Charge	—	1.3	—		
$Q_{gd}$	Gate-to-Drain Charge	—	3.0	—		
$Q_{godr}$	Gate Charge Overdrive	—	2.2	—		
$Q_{sw}$	Switch Charge ( $Q_{gs2} + Q_{gd}$ )	—	4.3	—		
$Q_{oss}$	Output Charge	—	4.4	—	nC	$V_{DS} = 10V, V_{GS} = 0V$
$R_G$	Gate Resistance	—	0.3	—	Ω	
$t_{d(on)}$	Turn-On Delay Time	—	7.9	—	ns	$V_{DD} = 13V, V_{GS} = 4.5V$ ⑦ $I_D = 10A$ $R_G = 6.2\Omega$
$t_r$	Rise Time	—	20	—		
$t_{d(off)}$	Turn-Off Delay Time	—	5.2	—		
$t_f$	Fall Time	—	6.0	—		
$C_{iss}$	Input Capacitance	—	1190	—	pF	$V_{GS} = 0V$ $V_{DS} = 13V$ $f = 1.0\text{MHz}$
$C_{oss}$	Output Capacitance	—	320	—		
$C_{rss}$	Reverse Transfer Capacitance	—	150	—		

## Diode Characteristics

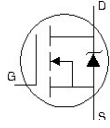
	Parameter	Min.	Typ.	Max.	Units	Conditions
$I_S$	Continuous Source Current (Body Diode)	—	—	19	A	MOSFET symbol showing the integral reverse p-n junction diode. 
$I_{SM}$	Pulsed Source Current (Body Diode) ⑤	—	—	100		
$V_{SD}$	Diode Forward Voltage	—	—	1.0	V	$T_J = 25^\circ\text{C}, I_S = 10A, V_{GS} = 0V$ ⑦
$t_{rr}$	Reverse Recovery Time	—	14	21	ns	$T_J = 25^\circ\text{C}, I_F = 10A$
$Q_{rr}$	Reverse Recovery Charge	—	8.0	12	nC	$di/dt = 200A/\mu s$ ⑦

### Notes:

- ⑤ Repetitive rating; pulse width limited by max. junction temperature.
- ⑦ Pulse width  $\leq 400\mu s$ ; duty cycle  $\leq 2\%$ .

**Absolute Maximum Ratings**

	Parameter	Max.	Units
$P_D @ T_A = 25^\circ\text{C}$	Power Dissipation ③	1.8	W
$P_D @ T_A = 70^\circ\text{C}$	Power Dissipation ③	1.3	
$P_D @ T_C = 25^\circ\text{C}$	Power Dissipation ④	15	
$T_P$	Peak Soldering Temperature	270	°C
$T_J$	Operating Junction and	-55 to + 175	
$T_{STG}$	Storage Temperature Range		

**Thermal Resistance**

	Parameter	Typ.	Max.	Units
$R_{\theta JA}$	Junction-to-Ambient ③ ⑩	—	82	°C/W
$R_{\theta JA}$	Junction-to-Ambient ③ ⑩	12.5	—	
$R_{\theta JA}$	Junction-to-Ambient ⑨ ⑩	20	—	
$R_{\theta JC}$	Junction-to-Case ④ ⑩	—	9.8	
$R_{\theta J-PCB}$	Junction-to-PCB Mounted	1.0	—	
	Linear Derating Factor ③	0.012		W/°C

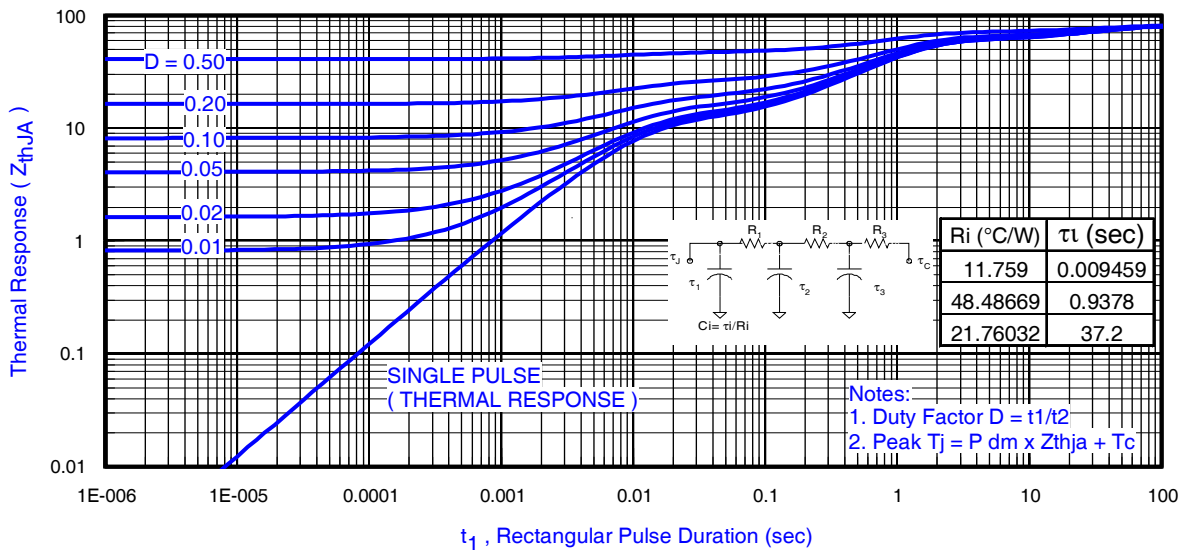

**Fig 3.** Maximum Effective Transient Thermal Impedance, Junction-to-Ambient ①

**Notes:**

- ③ Surface mounted on 1 in. square Cu board, steady state.
- ④  $T_C$  measured with thermocouple incontact with top (Drain) of part.
- ⑤ Used double sided cooling, mounting pad with large heatsink.
- ⑥ Mounted on minimum footprint full size board with metalized back and with small clip heatsink.
- ⑦  $R_{\theta}$  is measured at  $T_J$  of approximately  $90^\circ\text{C}$ .

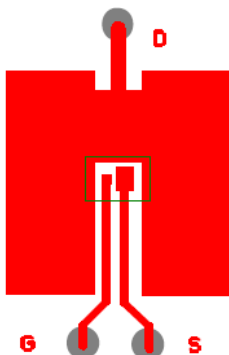

③ Surface mounted on 1 in. square Cu board (still air).

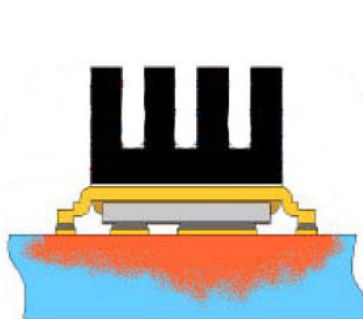

⑥ Mounted on minimum footprint full size board with metalized back and with small clip heatsink. (still air)

# IRF6710S2TR/TR1PbF

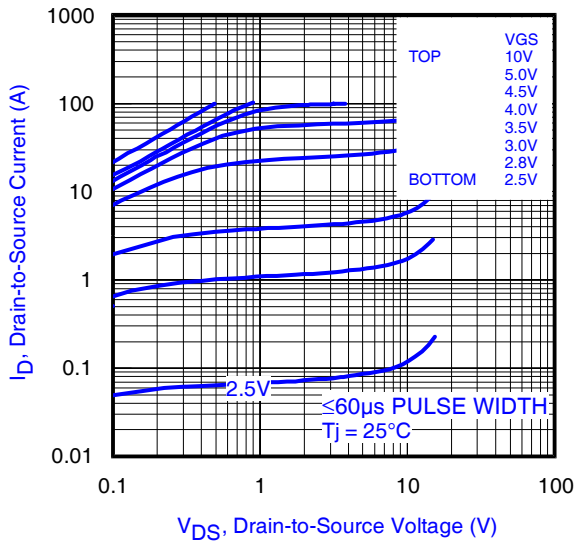

**Fig 4.** Typical Output Characteristics

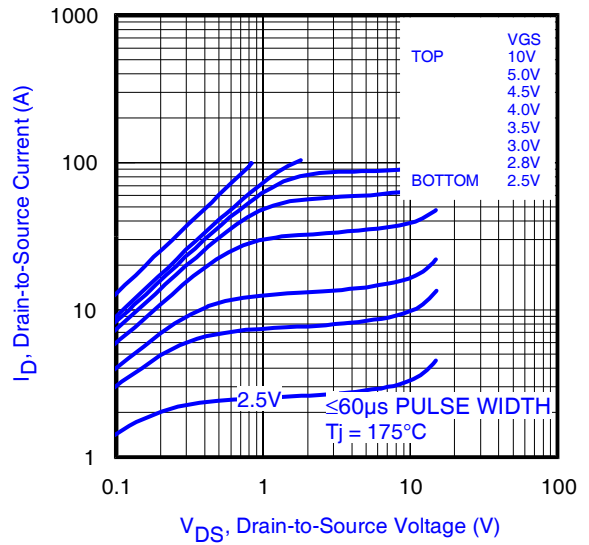

**Fig 5.** Typical Output Characteristics

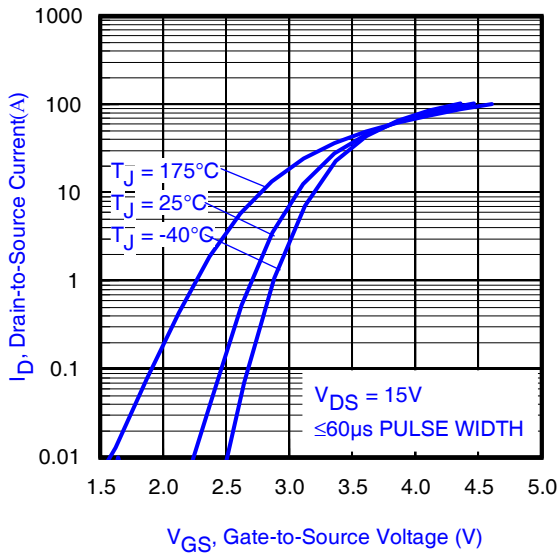

**Fig 6.** Typical Transfer Characteristics

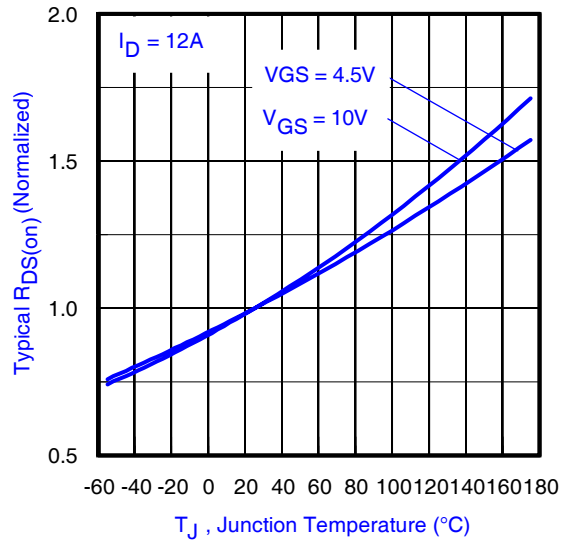

**Fig 7.** Normalized On-Resistance vs. Temperature

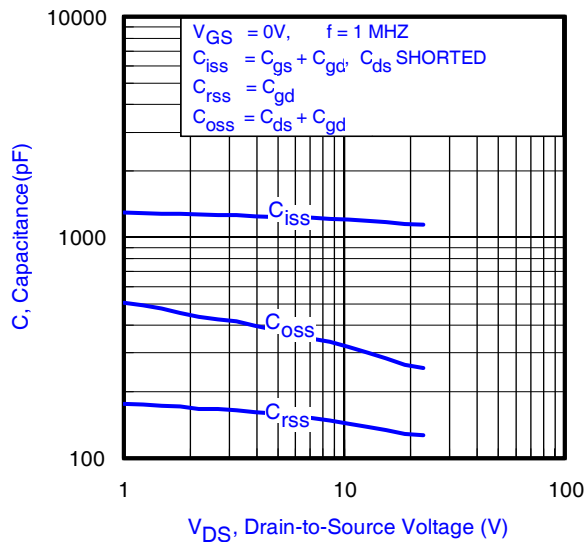

**Fig 8.** Typical Capacitance vs. Drain-to-Source Voltage

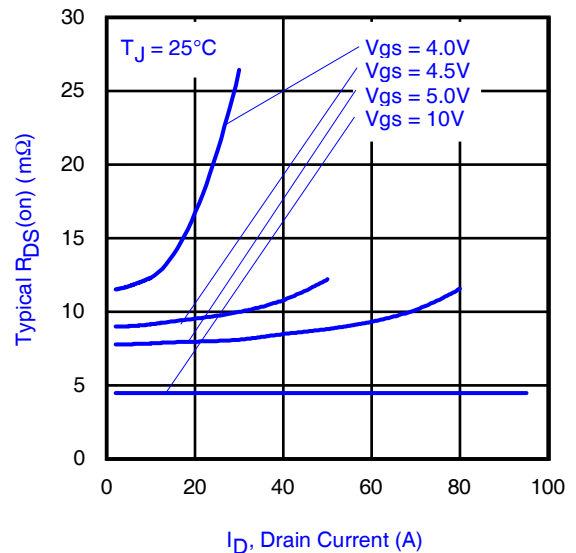

**Fig 9.** Typical On-Resistance vs. Drain Current and Gate Voltage

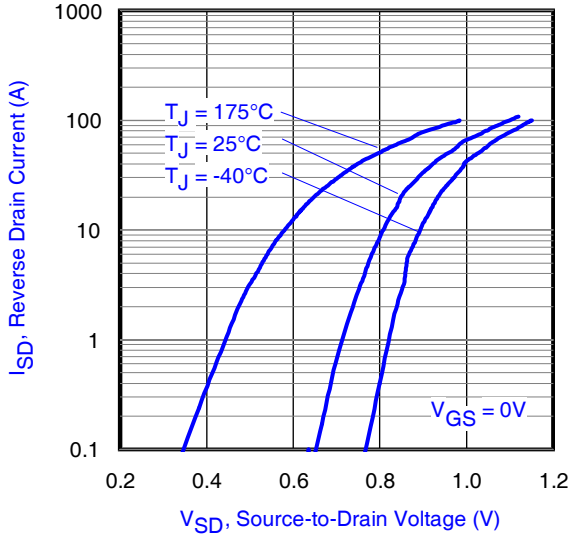

**Fig 10.** Typical Source-Drain Diode Forward Voltage

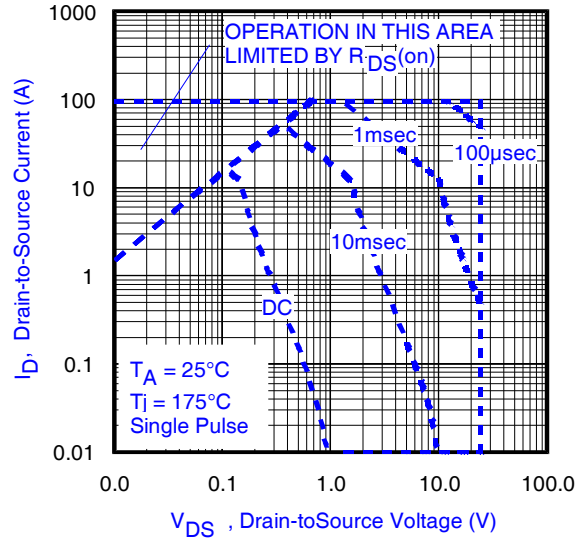

**Fig 11.** Maximum Safe Operating Area

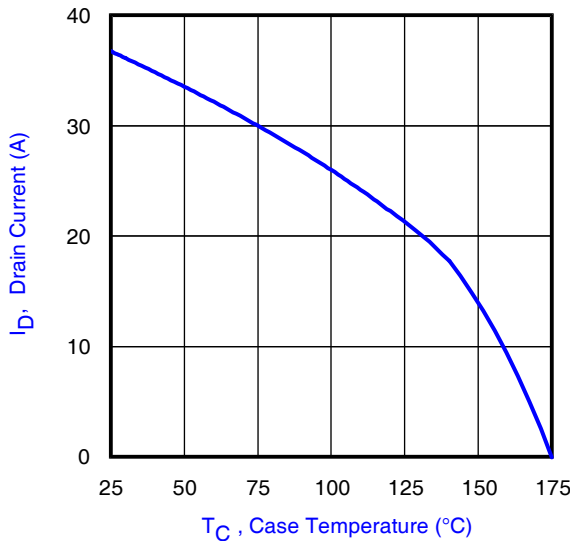

**Fig 12.** Maximum Drain Current vs. Case Temperature

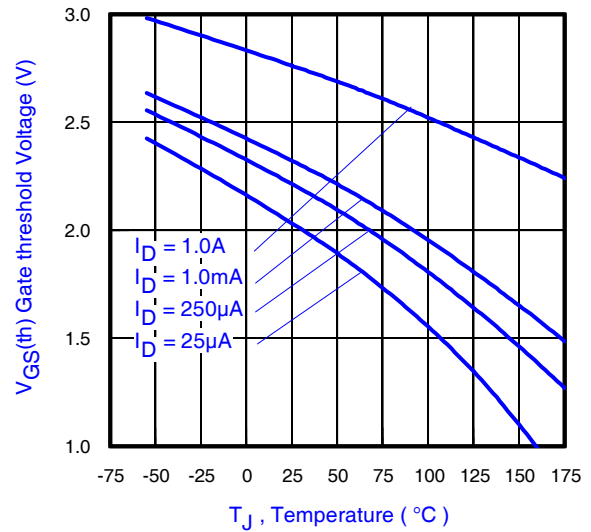

**Fig 13.** Typical Threshold Voltage vs. Junction Temperature

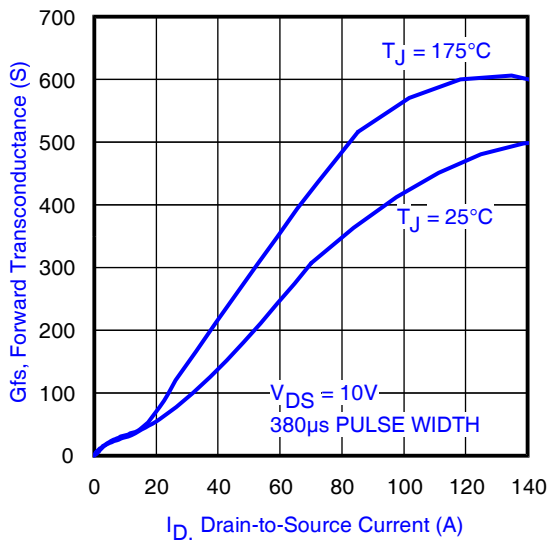

**Fig 14.** Typ. Forward Transconductance vs. Drain Current

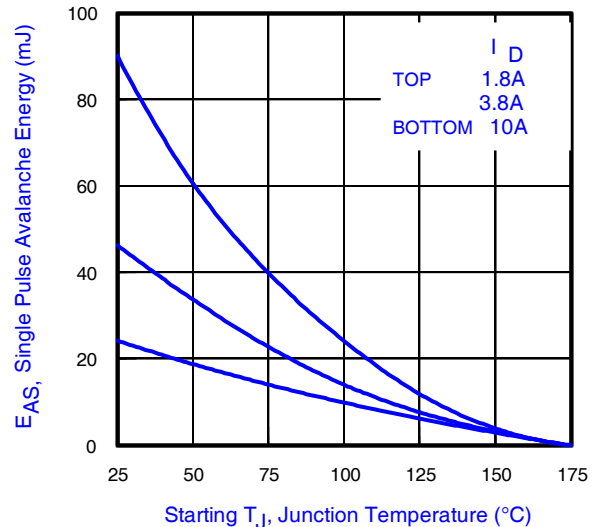

**Fig 15.** Maximum Avalanche Energy vs. Drain Current

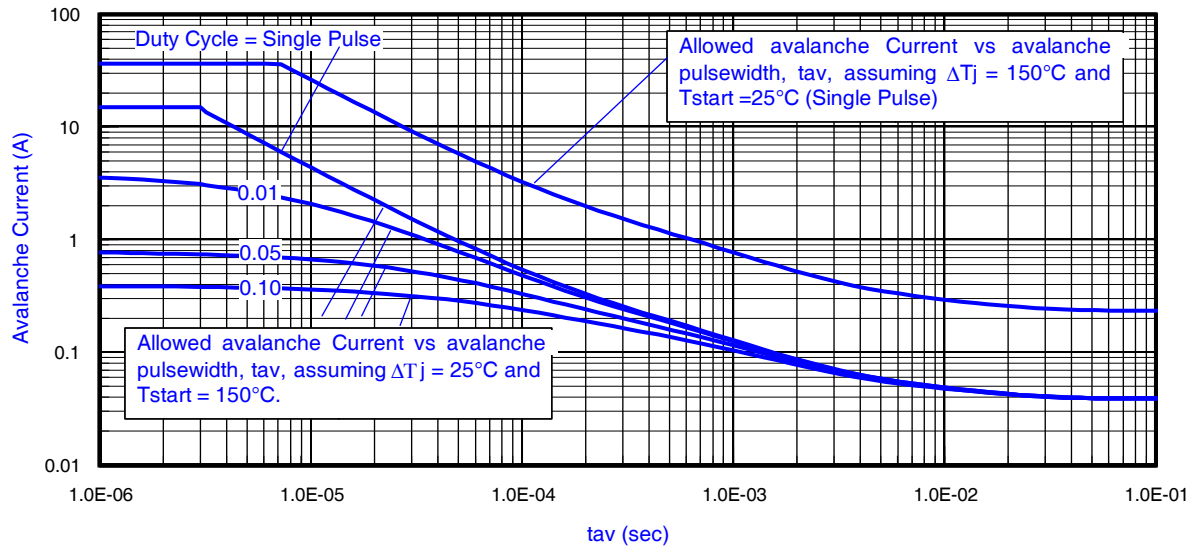

**Fig 16.** Typical Avalanche Current Vs.Pulsewidth

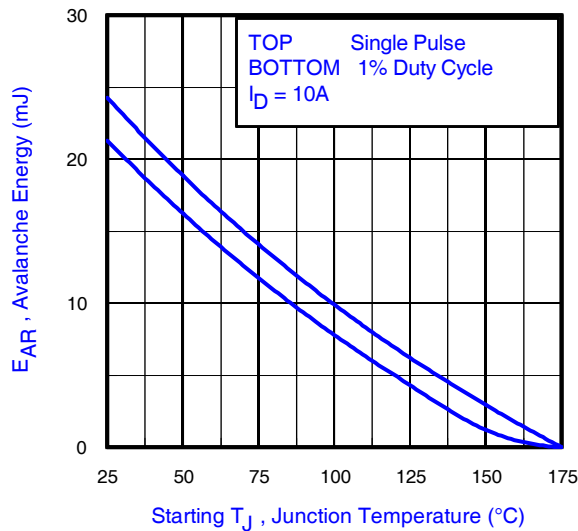

**Fig 17.** Maximum Avalanche Energy vs. Temperature

**Notes on Repetitive Avalanche Curves , Figures 16, 17:**  
**(For further info, see AN-1005 at www.irf.com)**

1. Avalanche failures assumption:  
Purely a thermal phenomenon and failure occurs at a temperature far in excess of  $T_{jmax}$ . This is validated for every part type.
2. Safe operation in Avalanche is allowed as long as  $T_{jmax}$  is not exceeded.
3. Equation below based on circuit and waveforms shown in Figures 19a, 19b.
4.  $P_{D(ave)}$  = Average power dissipation per single avalanche pulse.
5.  $BV$  = Rated breakdown voltage (1.3 factor accounts for voltage increase during avalanche).
6.  $I_{av}$  = Allowable avalanche current.
7.  $\Delta T$  = Allowable rise in junction temperature, not to exceed  $T_{jmax}$  (assumed as 25°C in Figure 16, 17).  
 $t_{av}$  = Average time in avalanche.  
 $D$  = Duty cycle in avalanche =  $t_{av} \cdot f$   
 $Z_{thJC}(D, t_{av})$  = Transient thermal resistance, see figure 11)

$$P_{D(ave)} = 1/2 ( 1.3 \cdot BV \cdot I_{av} ) = \Delta T / Z_{thJC}$$

$$I_{av} = 2\Delta T / [1.3 \cdot BV \cdot Z_{th}]$$

$$E_{AS(AR)} = P_{D(ave)} \cdot t_{av}$$

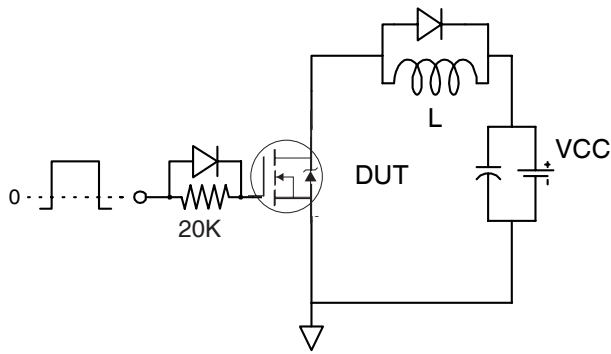

**Fig 18a.** Gate Charge Test Circuit

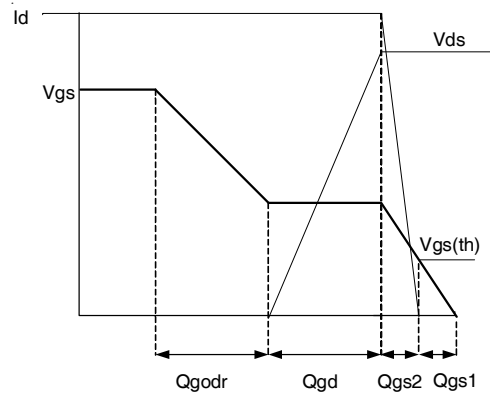

**Fig 18b.** Gate Charge Waveform

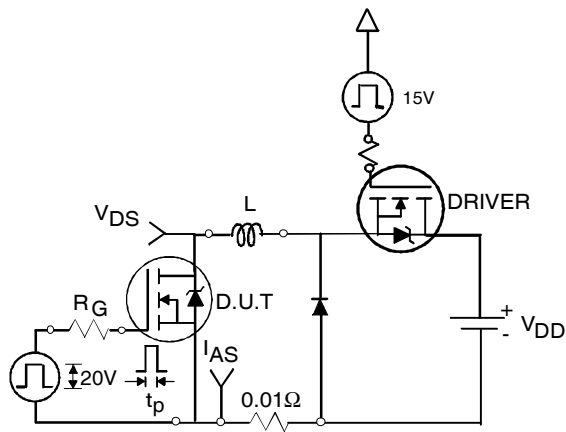

**Fig 19a.** Unclamped Inductive Test Circuit



**Fig 19b.** Unclamped Inductive Waveforms

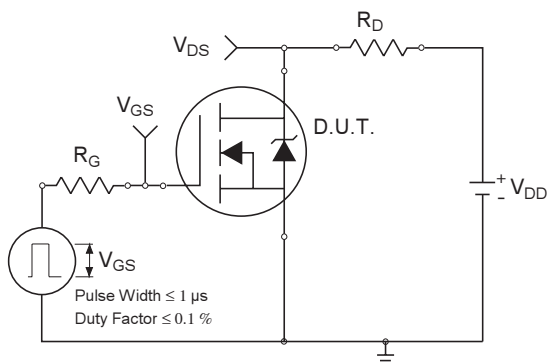

**Fig 20a.** Switching Time Test Circuit

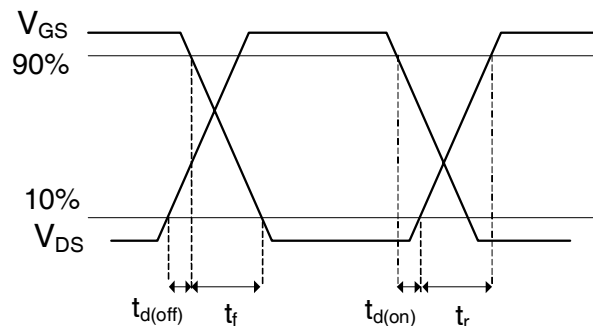

**Fig 20b.** Switching Time Waveforms

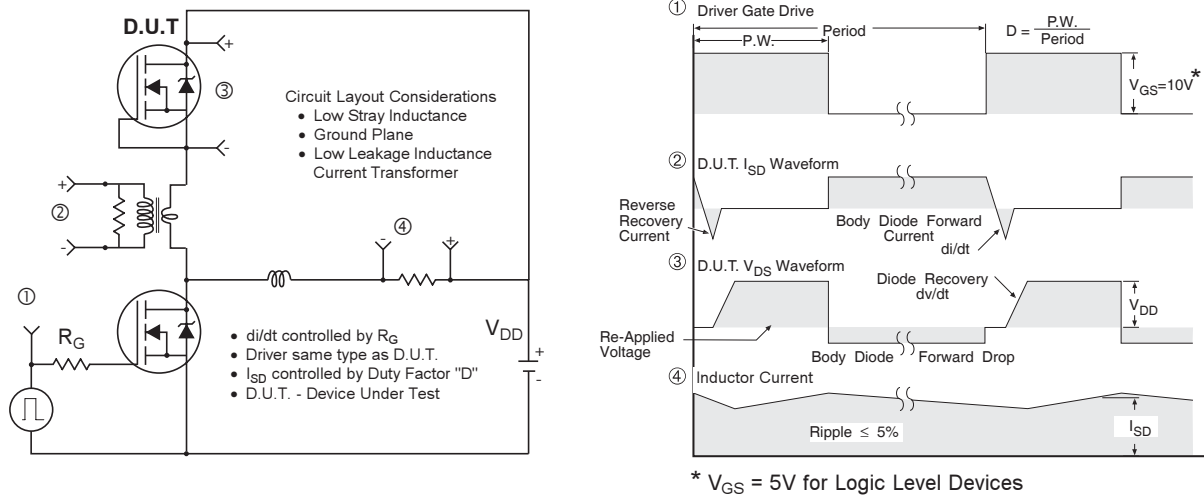
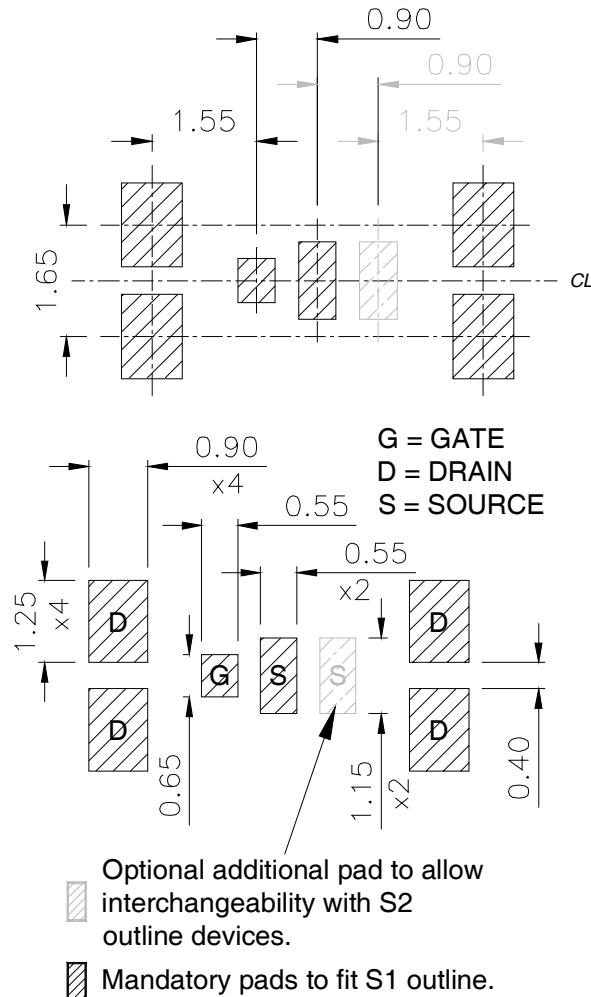

**Fig 19.** Diode Reverse Recovery Test Circuit for N-Channel HEXFET® Power MOSFETs

## DirectFET™ Board Footprint, S1 Outline (Small Size Can).

Please see DirectFET application note AN-1035 for all details regarding the assembly of DirectFET.

This includes all recommendations for stencil and substrate designs.





## DirectFET™ Outline Dimension, S1 Outline (Small Size Can).

Please see AN-1035 for DirectFET assembly details and stencil and substrate design recommendations

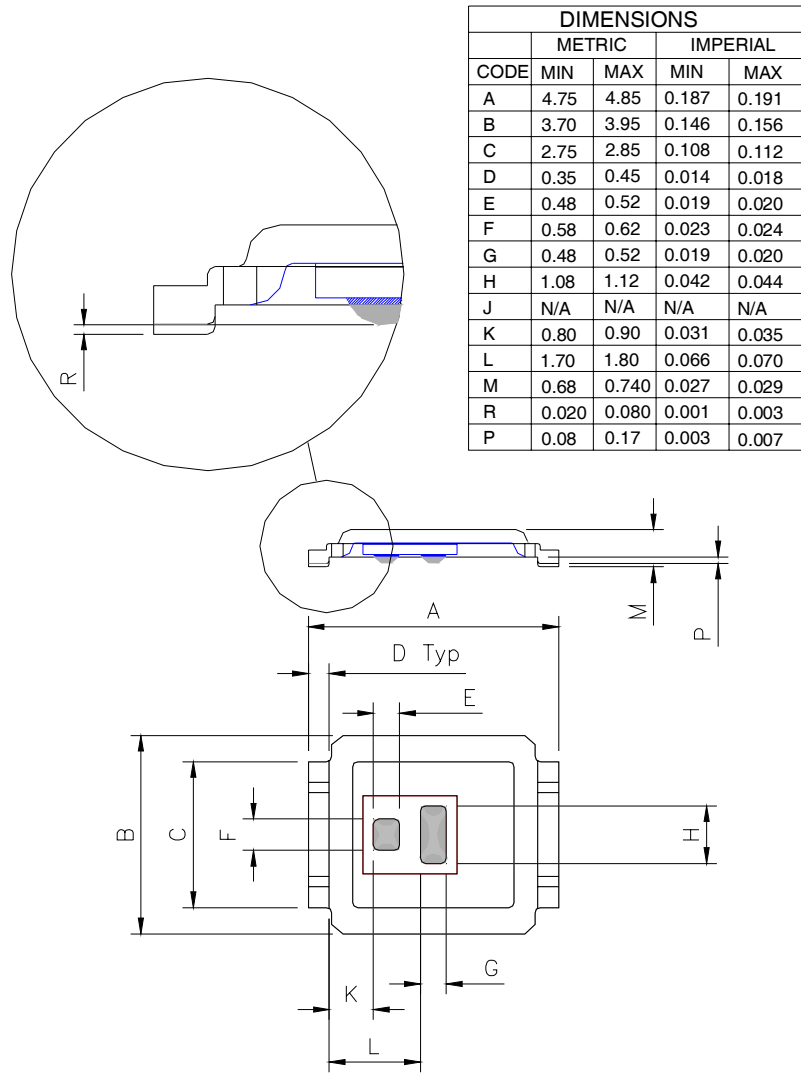

## DirectFET™ Part Marking

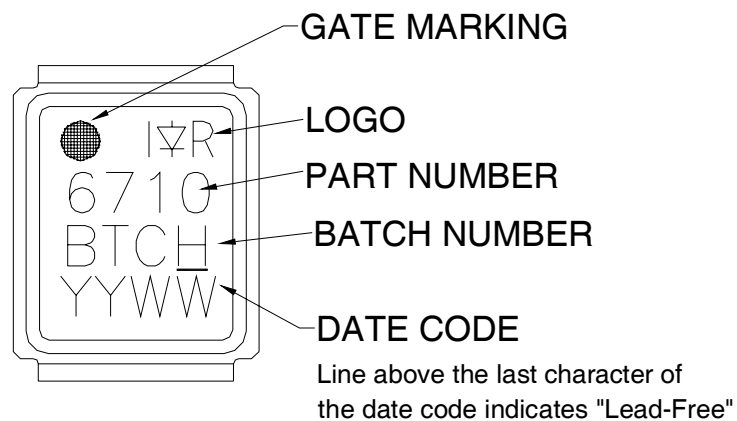

# IRF6710S2TR/TR1PbF

DirectFET™ Tape & Reel Dimension (Showing component orientation).

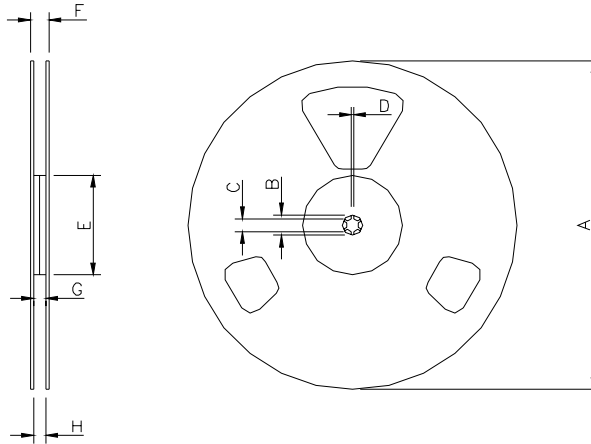

NOTE: Controlling dimensions in mm  
Std reel quantity is 4800 parts. (ordered as IRF6710S2TRPBF). For 1000 parts on 7" reel, order IRF6710S2TR1PBF

REEL DIMENSIONS								
CODE	STANDARD OPTION (QTY 4800)				TR1 OPTION (QTY 1000)			
	METRIC		IMPERIAL		METRIC		IMPERIAL	
A	330.0	N.C	12.992	N.C	177.77	N.C	6.9	N.C
B	20.2	N.C	0.795	N.C	19.06	N.C	0.75	N.C
C	12.8	13.2	0.504	0.520	13.5	12.8	0.53	0.50
D	1.5	N.C	0.059	N.C	1.5	N.C	0.059	N.C
E	100.0	N.C	3.937	N.C	58.72	N.C	2.31	N.C
F	N.C	18.4	N.C	0.724	N.C	13.50	N.C	0.53
G	12.4	14.4	0.488	0.567	11.9	12.01	0.47	N.C
H	11.9	15.4	0.469	0.606	11.9	12.01	0.47	N.C

LOADED TAPE FEED DIRECTION

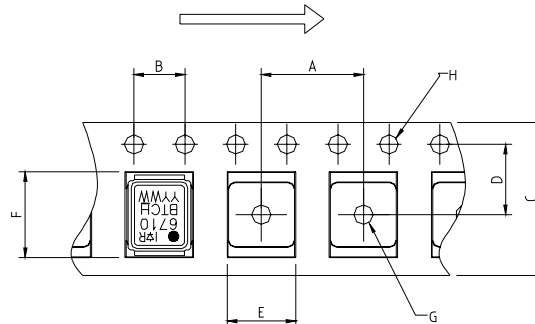

NOTE: CONTROLLING DIMENSIONS IN MM

CODE	DIMENSIONS			
	METRIC		IMPERIAL	
A	7.90	8.10	0.311	0.319
B	3.90	4.10	0.154	0.161
C	11.90	12.30	0.469	0.484
D	5.45	5.55	0.215	0.219
E	5.10	5.30	0.201	0.209
F	6.50	6.70	0.256	0.264
G	1.50	N.C	0.059	N.C
H	1.50	1.60	0.059	0.063

Data and specifications subject to change without notice.

This product has been designed and qualified to MSL1 rating for the Consumer market.

Additional storage requirement details for DirectFET products can be found in application note AN1035 on IR's Web site.

Qualification Standards can be found on IR's Web site.

# Mouser Electronics

Authorized Distributor

Click to View Pricing, Inventory, Delivery & Lifecycle Information:

[International Rectifier:](#)

[IRF6710S2TRPBF](#)