

# IRFB812PbF

HEXFET® Power MOSFET

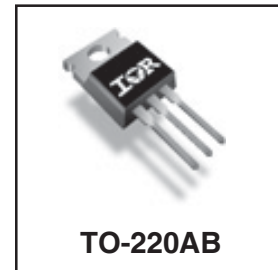
## Applications

- Zero Voltage Switching SMPS
- Uninterruptible Power Supplies
- Motor Control applications

$V_{DSS}$	$R_{DS(on)}$ typ.	$T_{rr}$ typ.	$I_D$
500V	1.75Ω	75ns	3.6A

## Features and Benefits

- Fast body diode eliminates the need for external diodes in ZVS applications.
- Lower Gate charge results in simpler drive requirements.
- Higher Gate voltage threshold offers improved noise immunity.



## Absolute Maximum Ratings

	Parameter	Max.	Units
$I_D$ @ $T_C = 25^\circ\text{C}$	Continuous Drain Current, $V_{GS}$ @ 10V	3.6	A
$I_D$ @ $T_C = 100^\circ\text{C}$	Continuous Drain Current, $V_{GS}$ @ 10V	2.3	
$I_{DM}$	Pulsed Drain Current ①	14.4	
$P_D$ @ $T_C = 25^\circ\text{C}$	Power Dissipation	78	W
	Linear Derating Factor	0.63	W/°C
$V_{GS}$	Gate-to-Source Voltage	± 20	V
dv/dt	Peak Diode Recovery dv/dt ③	32	V/ns
$T_J$ $T_{STG}$	Operating Junction and Storage Temperature Range	-55 to + 150	°C
	Soldering Temperature, for 10 seconds	300 (1.6mm from case )	
	Mounting torque, 6-32 or M3 screw	10lb·in (1.1N·m)	

## Diode Characteristics

Symbol	Parameter	Min.	Typ.	Max.	Units	Conditions
$I_S$	Continuous Source Current (Body Diode)	—	—	3.6	A	MOSFET symbol showing the integral reverse p-n junction diode.
$I_{SM}$	Pulsed Source Current (Body Diode) ①	—	—	14.4		
$V_{SD}$	Diode Forward Voltage	—	—	1.2	V	$T_J = 25^\circ\text{C}$ , $I_S = 3.6\text{A}$ , $V_{GS} = 0\text{V}$ ④
$t_{rr}$	Reverse Recovery Time	—	75	110	ns	$T_J = 25^\circ\text{C}$ , $I_F = 3.6\text{A}$
		—	94	140		$T_J = 125^\circ\text{C}$ , $di/dt = 100\text{A}/\mu\text{s}$ ④
$Q_{rr}$	Reverse Recovery Charge	—	135	200	nC	$T_J = 25^\circ\text{C}$ , $I_S = 3.6\text{A}$ , $V_{GS} = 0\text{V}$ ④
		—	220	330		$T_J = 125^\circ\text{C}$ , $di/dt = 100\text{A}/\mu\text{s}$ ④
$I_{RRM}$	Reverse Recovery Current	—	3.2	4.8	A	$T_J = 25^\circ\text{C}$
$t_{on}$	Forward Turn-On Time	Intrinsic turn-on time is negligible (turn-on is dominated by LS+LD)				

Notes ① through ⑥ are on page 2

www.irf.com

# IRFB812PbF

International  
IR Rectifier

## Static @ $T_J = 25^\circ\text{C}$ (unless otherwise specified)

Symbol	Parameter	Min.	Typ.	Max.	Units	Conditions
$V_{(BR)DSS}$	Drain-to-Source Breakdown Voltage	500	—	—	V	$V_{GS} = 0V, I_D = 250\mu\text{A}$
$\Delta V_{(BR)DSS}/\Delta T_J$	Breakdown Voltage Temp. Coefficient	—	0.37	—	V/°C	Reference to $25^\circ\text{C}, I_D = 250\mu\text{A}$
$R_{DS(on)}$	Static Drain-to-Source On-Resistance	—	1.75	2.2	$\Omega$	$V_{GS} = 10V, I_D = 2.2A$ ④
$V_{GS(th)}$	Gate Threshold Voltage	3.0	—	5.0	V	$V_{DS} = V_{GS}, I_D = 250\mu\text{A}$
$I_{DSS}$	Drain-to-Source Leakage Current	—	—	25	$\mu\text{A}$	$V_{DS} = 500V, V_{GS} = 0V$
		—	—	2.0	mA	$V_{DS} = 400V, V_{GS} = 0V, T_J = 125^\circ\text{C}$
$I_{GSS}$	Gate-to-Source Forward Leakage	—	—	100	nA	$V_{GS} = 20V$
	Gate-to-Source Reverse Leakage	—	—	-100	nA	$V_{GS} = -20V$

## Dynamic @ $T_J = 25^\circ\text{C}$ (unless otherwise specified)

Symbol	Parameter	Min.	Typ.	Max.	Units	Conditions
$g_{fs}$	Forward Transconductance	7.6	—	—	S	$V_{DS} = 50V, I_D = 2.2A$
$Q_g$	Total Gate Charge	—	—	20	nC	$I_D = 3.6A$ $V_{DS} = 400V$ $V_{GS} = 10V$ , See Fig.14a & 14b ④
$Q_{gs}$	Gate-to-Source Charge	—	—	7.3		
$Q_{gd}$	Gate-to-Drain ("Miller") Charge	—	—	7.1		
$t_{d(on)}$	Turn-On Delay Time	—	14	—	ns	$V_{DD} = 250V$ $I_D = 3.6A$ $R_G = 17\Omega$ $V_{GS} = 10V$ , See Fig. 15a & 15b ④
$t_r$	Rise Time	—	22	—		
$t_{d(off)}$	Turn-Off Delay Time	—	24	—		
$t_f$	Fall Time	—	17	—		
$C_{iss}$	Input Capacitance	—	810	—	pF	$V_{GS} = 0V$ $V_{DS} = 25V$ $f = 1.0\text{MHz}$ , See Fig. 5 $V_{GS} = 0V, V_{DS} = 1.0V, f = 1.0\text{MHz}$ $V_{GS} = 0V, V_{DS} = 400V, f = 1.0\text{MHz}$ $V_{GS} = 0V, V_{DS} = 0V$ to $400V$ ⑤
$C_{oss}$	Output Capacitance	—	47	—		
$C_{riss}$	Reverse Transfer Capacitance	—	7.3	—		
$C_{oss}$	Output Capacitance	—	610	—		
$C_{oss}$	Output Capacitance	—	16	—		
$C_{oss \text{ eff.}}$	Effective Output Capacitance	—	5.9	—		
$C_{oss \text{ eff. (ER)}}$	Effective Output Capacitance (Energy Related)	—	37	—		

## Avalanche Characteristics

Symbol	Parameter	Typ.	Max.	Units
$E_{AS}$	Single Pulse Avalanche Energy ②	—	150	mJ
$I_{AR}$	Avalanche Current ①	—	1.8	A
$E_{AR}$	Repetitive Avalanche Energy ①	—	7.8	mJ

## Thermal Resistance

Symbol	Parameter	Typ.	Max.	Units
$R_{\theta JC}$	Junction-to-Case ⑥	—	1.6	°C/W
$R_{\theta CS}$	Case-to-Sink, Flat, Greased Surface	0.5	—	
$R_{\theta JA}$	Junction-to-Ambient ⑥	—	62	

### Notes:

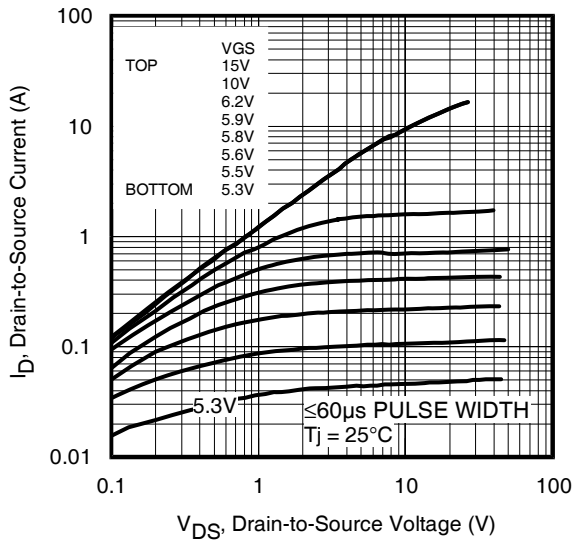
- ① Repetitive rating; pulse width limited by max. junction temperature. (See Fig. 11)
- ② Starting  $T_J = 25^\circ\text{C}$ ,  $L = 93\text{mH}$ ,  $R_G = 25\Omega$ ,  $I_{AS} = 1.8A$ . (See Figure 13).
- ③  $I_{SD} = 3.6A$ ,  $di/dt \leq 520A/\mu\text{s}$ ,  $V_{DD}V_{(BR)DSS}$ ,  $T_J \leq 150^\circ\text{C}$ .

④ Pulse width  $\leq 300\mu\text{s}$ ; duty cycle  $\leq 2\%$ .

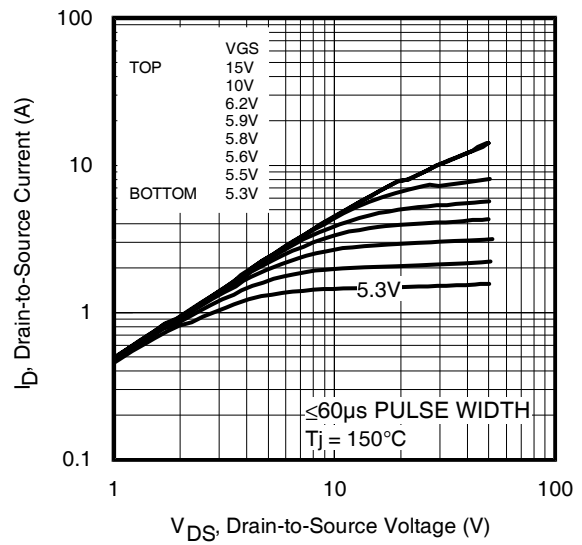
⑤  $C_{oss \text{ eff.}}$  is a fixed capacitance that gives the same charging time as  $C_{oss}$  while  $V_{DS}$  is rising from 0 to 80%  $V_{DSS}$ .

$C_{oss \text{ eff. (ER)}}$  is a fixed capacitance that stores the same energy as  $C_{oss}$  while  $V_{DS}$  is rising from 0 to 80%  $V_{DSS}$ .

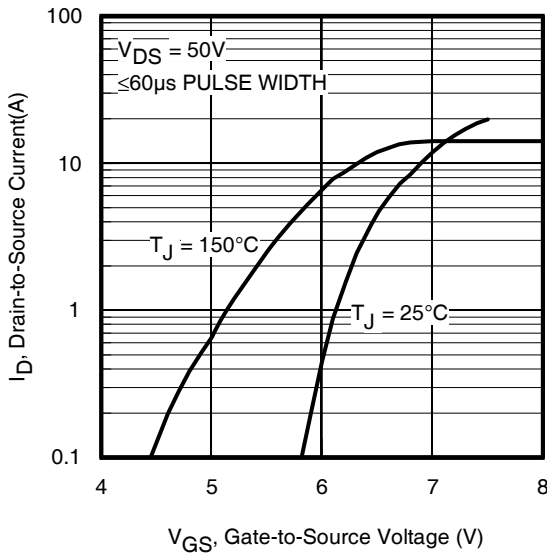
⑥  $R_{\theta}$  is measured at  $T_J$  approximately  $90^\circ\text{C}$



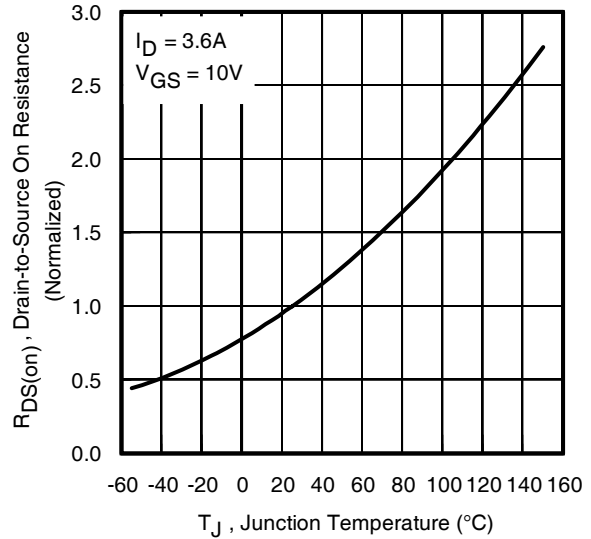
**Fig 1.** Typical Output Characteristics



**Fig 2.** Typical Output Characteristics

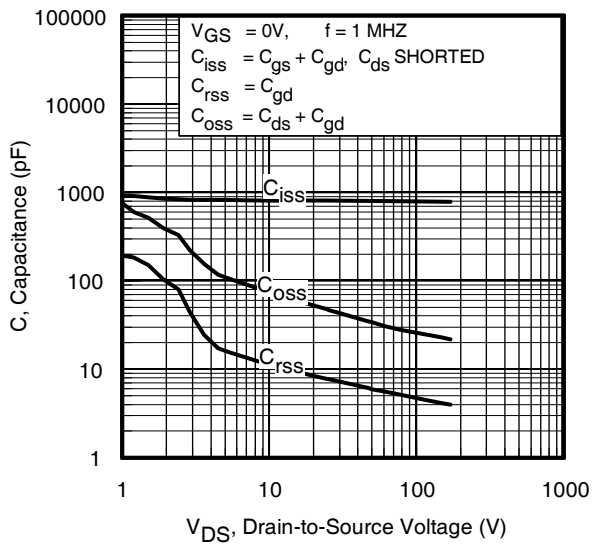


**Fig 3.** Typical Transfer Characteristics

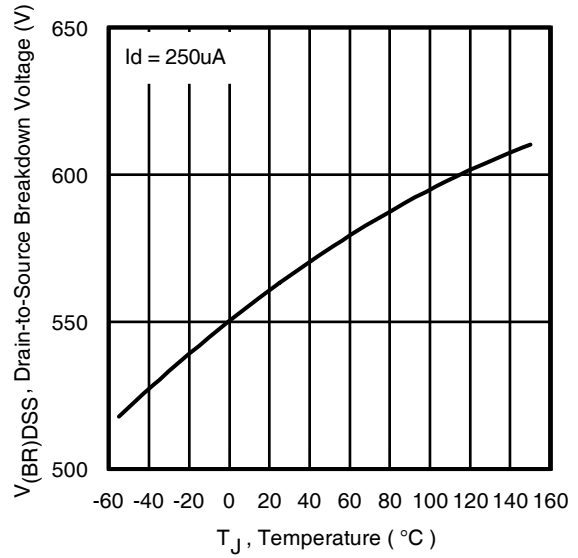


**Fig 4.** Normalized On-Resistance Vs. Temperature

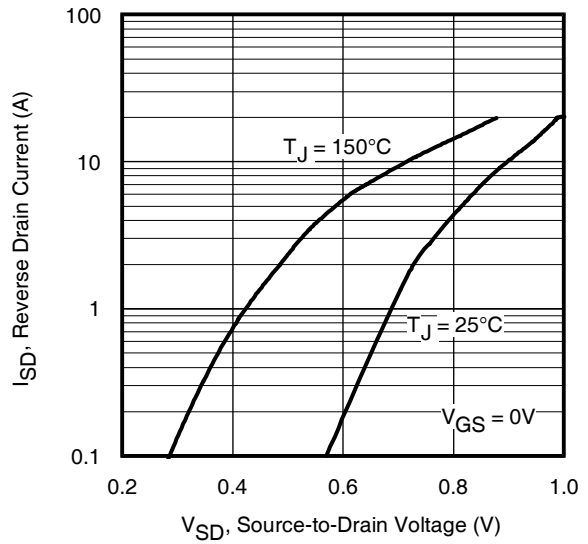
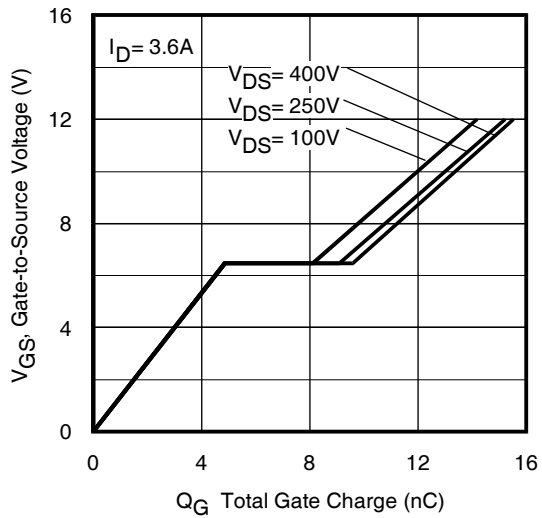
# IRFB812PbF

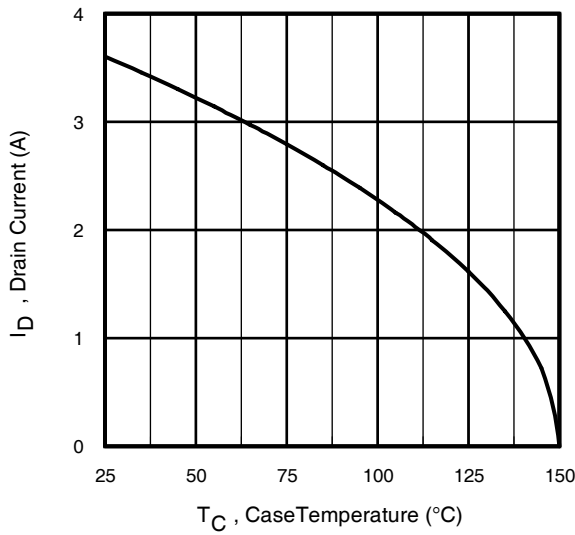


**Fig 5.** Typical Capacitance Vs. Drain-to-Source Voltage

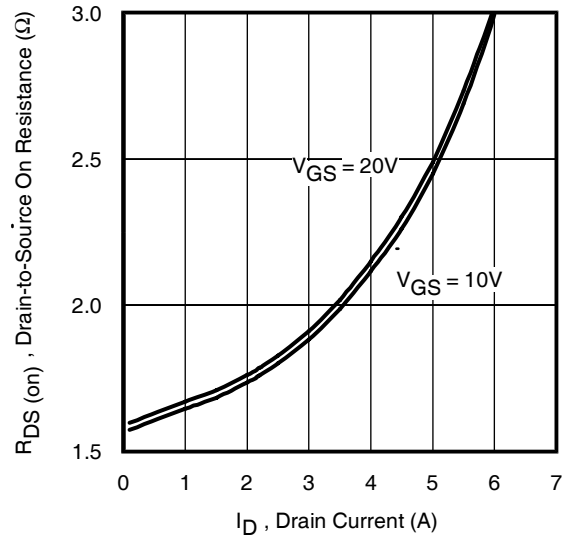


**Fig 6.** Typ. Breakdown Voltage vs. Temperature

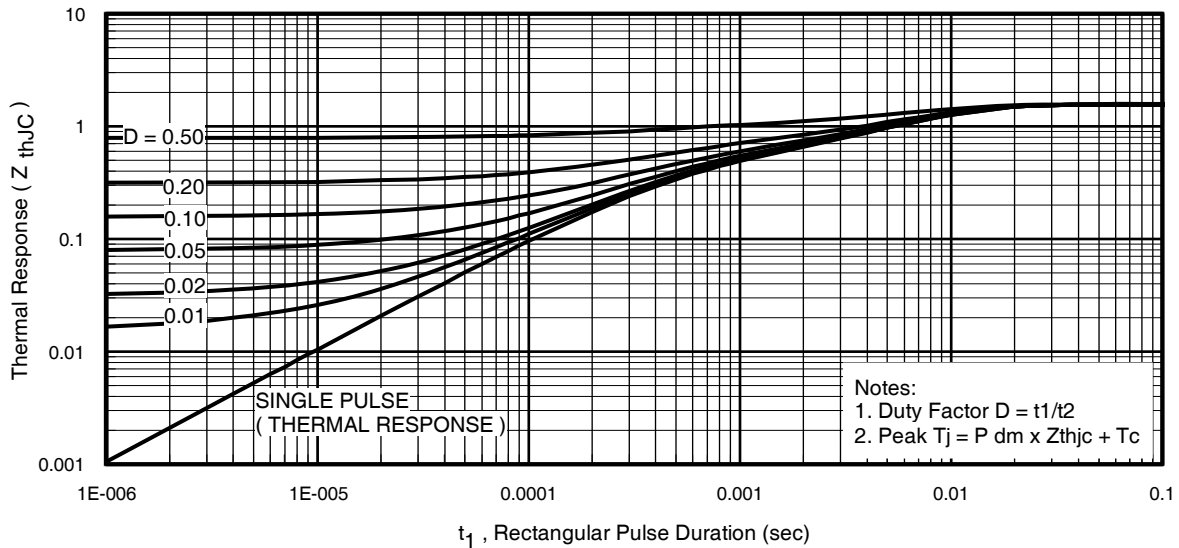




**Fig 9.** Maximum Drain Current Vs. Case Temperature



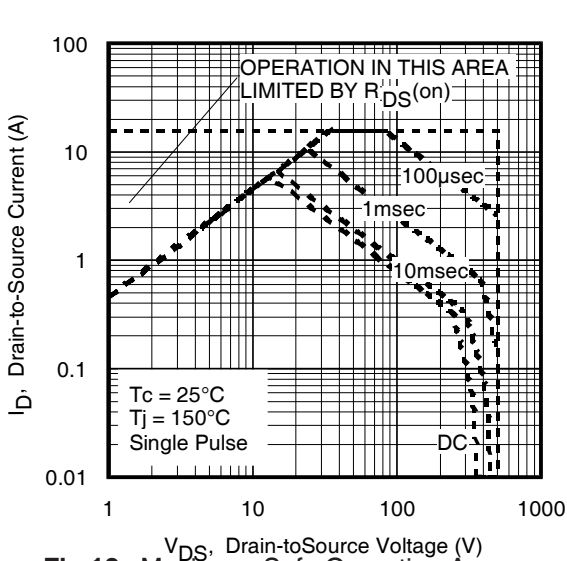
**Fig 9.** Typical  $R_{DS(on)}$  Vs. Drain Current



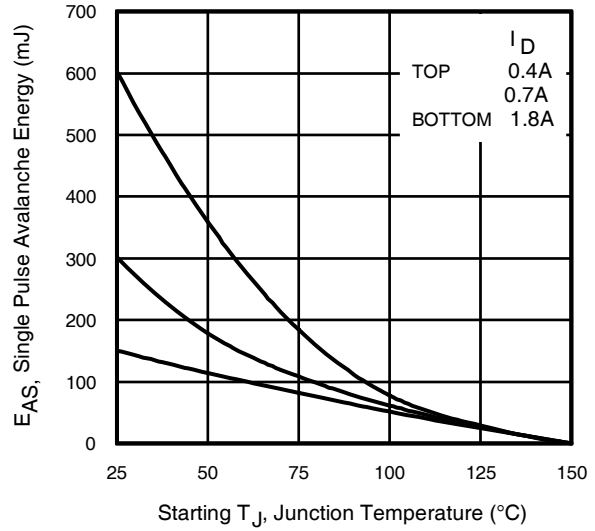
**Fig 11.** Maximum Effective Transient Thermal Impedance, Junction-to-Case

# IRFB812PbF

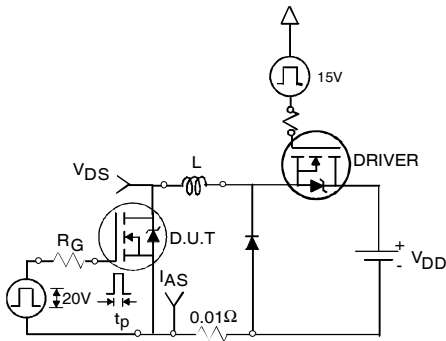
International  
**IR** Rectifier



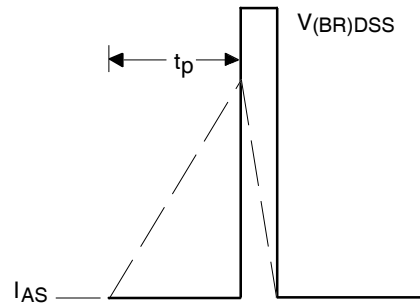
**Fig 12.** Maximum Safe Operating Area



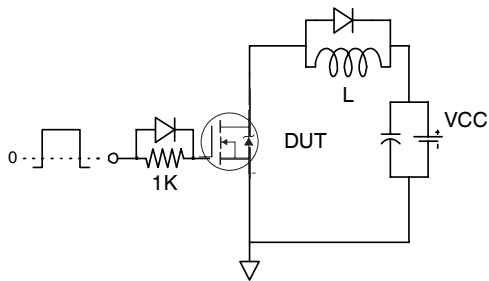
**Fig 13.** Maximum Avalanche Energy vs. Drain Current



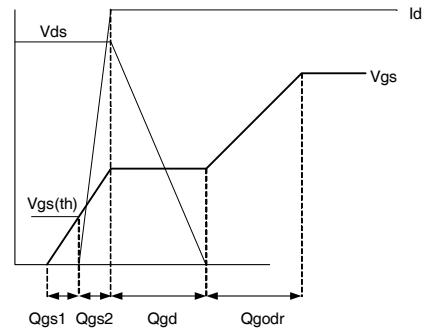
**Fig 13a.** Unclamped Inductive Test Circuit



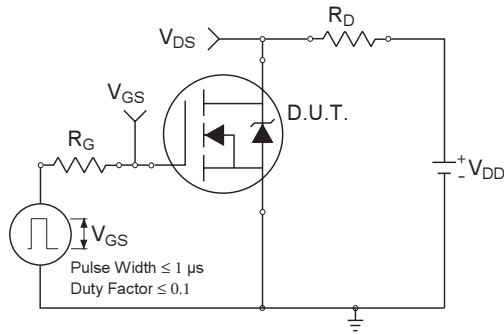
**Fig 13b.** Unclamped Inductive Waveforms



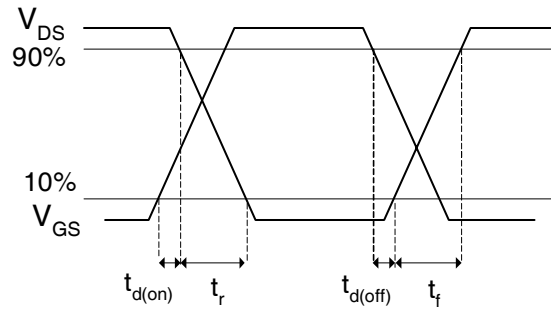
**Fig 14a.** Gate Charge Test Circuit



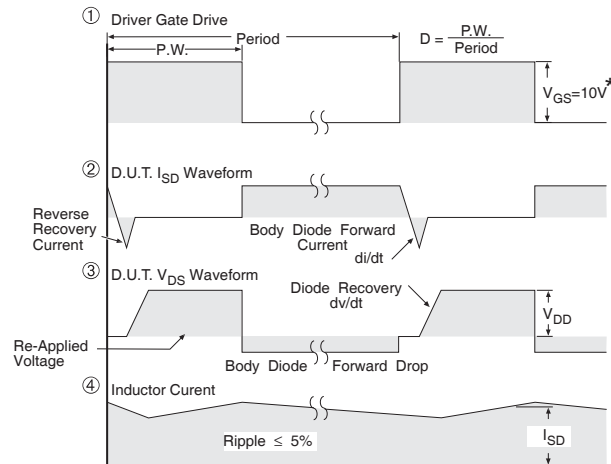
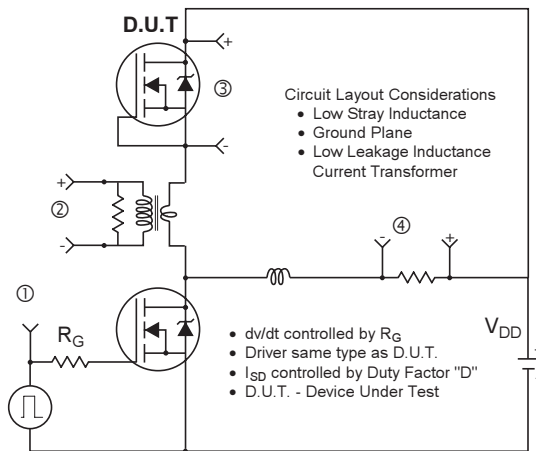
**Fig 14b.** Gate Charge Waveform



**Fig 15a.** Switching Time Test Circuit



**Fig 15b.** Switching Time Waveforms



\*  $V_{GS} = 5V$  for Logic Level Devices

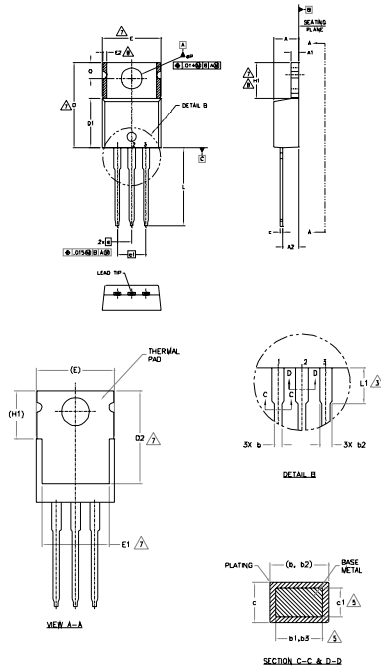
**Fig 16.** Peak Diode Recovery  $dv/dt$  Test Circuit for N-Channel HEXFET<sup>®</sup> Power MOSFETs

# IRFB812PbF

## TO-220AB Package Outline

Dimensions are shown in millimeters (inches)

International  
**IR** Rectifier



- NOTES:
- 1.- DIMENSIONING AND TOLERANCING AS PER ASME Y14.5 M-1994
  - 2.- DIMENSIONS ARE SHOWN IN INCHES (MILLIMETERS)
  - 3.- LEAD DIMENSION AND FINISH UNCONTROLLED IN LT
  - 4.- DIMENSION D1, D1 & E DO NOT INCLUDE WELD FLASH; WELD FLASH SHALL NOT EXCEED .005" (0.127) PER SIDE. THESE DIMENSIONS ARE MEASURED AT THE OUTERMOST EXTREMES OF THE PLASTIC BODY.
  - 5.- DIMENSION B1, B2 & C1 APPLY TO BASE METAL ONLY.
  - 6.- CONTROLLING DIMENSION IS INCHES.
  - 7.- THERMAL PAD CONTOUR OPTIONAL WITHIN DIMENSIONS E1, D2 & E1
  - 8.- DIMENSION E2 X H1 DEFINE A ZONE WHERE STAMPING AND SIMULATION IRREGULARITIES ARE ALLOWED.
  - 9.- OUTLINE CONFORMS TO JEDEC TO-220, EXCEPT A2 (max.) AND D2 (min.) WHERE DIMENSIONS ARE DERIVED FROM THE ACTUAL PACKAGE OUTLINE.

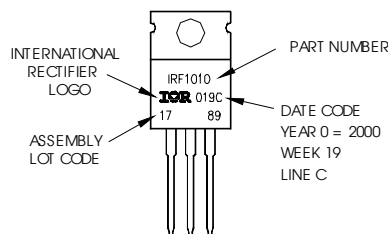
SYMBOL	DIMENSIONS				NOTES
	MILLIMETERS		INCHES		
	MIN.	MAX.	MIN.	MAX.	
A	3.56	4.83	.140	.190	
A1	0.51	1.40	.020	.056	
A2	2.03	2.92	.080	.115	
b	0.38	1.01	.015	.040	
b1	0.38	0.97	.015	.038	5
b2	1.14	1.78	.045	.070	
b3	1.14	1.73	.045	.068	5
c	0.36	0.61	.014	.024	
c1	0.36	0.56	.014	.022	5
D	14.22	16.51	.560	.650	4
D1	8.38	9.02	.330	.355	
D2	11.58	12.88	.460	.507	
E	9.65	10.67	.380	.420	4,7
E1	6.86	8.89	.270	.350	7
E2	-	0.76	-	.030	8
e	2.54	2.54	.100	.100	
e1	0.76	0.76	.030	.030	
H1	5.84	6.86	.230	.270	7,8
L	12.70	14.75	.500	.580	
L1	3.56	4.06	.140	.160	5
MP	3.54	4.08	.139	.161	
Q	2.54	3.42	.100	.135	

- LEAD ASSIGNMENTS
- 1.- GATE
  - 2.- DIODE
  - 3.- SOURCE
- WELD SYMBOLS
- 1.- GATE
  - 2.- DIODE
  - 3.- EMITTER
- DIODES
- 1.- ANODE
  - 2.- CATHODE
  - 3.- ANODE

## TO-220AB Part Marking Information

EXAMPLE: THIS IS AN IRF1010  
LOT CODE 1789  
ASSEMBLED ON WW 19, 2000  
IN THE ASSEMBLY LINE "C"

Note: "P" in assembly line position indicates "Lead-Free"



TO-220AB packages are not recommended for Surface Mount Application.

Note: For the most current drawing please refer to IR website at <http://www.irf.com/package/>

Data and specifications subject to change without notice.  
This product has been designed and qualified for the Industrial market.  
Qualification Standards can be found on IR's Web site.

International  
**IR** Rectifier

IR WORLD HEADQUARTERS: 233 Kansas St., El Segundo, California 90245, USA Tel: (310) 252-7105  
TAC Fax: (310) 252-7903

Visit us at [www.irf.com](http://www.irf.com) for sales contact information.06/11

[www.irf.com](http://www.irf.com)



# Mouser Electronics

Authorized Distributor

Click to View Pricing, Inventory, Delivery & Lifecycle Information:

[International Rectifier:](#)

[IRFB812PBF](#)