

HEXFET® Power MOSFET

**Application**

- Optimized for UPS/Inverter Applications
- Low Voltage Power Tools

**Benefits**

- Fully Characterized Avalanche Voltage and Current
- Lead-Free, RoHS Compliant

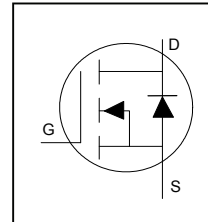

<b>V<sub>DS</sub></b>	<b>30</b>	<b>V</b>
<b>R<sub>DS(on)</sub> max</b> (@ V <sub>GS</sub> = 10V)	<b>2.2</b>	<b>mΩ</b>
(@ V <sub>GS</sub> = 4.5V)	<b>3.1</b>	
<b>Q<sub>g</sub> (typical)</b>	<b>40</b>	<b>nC</b>
<b>I<sub>D</sub> (Silicon Limited)</b>	<b>179</b> ①	<b>A</b>
<b>I<sub>D</sub> (Package Limited)</b>	<b>90A</b>	

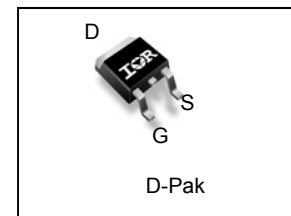

<b>G</b>	<b>D</b>	<b>S</b>
Gate	Drain	Source

Base part number	Package Type	Standard Pack		Orderable Part Number
		Form	Quantity	
IRFR8314PbF	D-Pak	Tape and Reel	2000	IRFR8314TRPbF

**Absolute Maximum Rating**

Symbol	Parameter	Max.	Units
V <sub>DS</sub>	Drain-to-Source Voltage	30	V
V <sub>GS</sub>	Gate-to-Source Voltage	± 20	
I <sub>D</sub> @ T <sub>C</sub> = 25°C	Continuous Drain Current, V <sub>GS</sub> @ 10V (Silicon Limited)	179①	A
I <sub>D</sub> @ T <sub>C</sub> = 100°C	Continuous Drain Current, V <sub>GS</sub> @ 10V (Silicon Limited)	127①	
I <sub>D</sub> @ T <sub>C</sub> = 25°C	Continuous Drain Current, V <sub>GS</sub> @ 10V (Package Limited)	90	
I <sub>DM</sub>	Pulsed Drain Current ②	357	
P <sub>D</sub> @ T <sub>C</sub> = 25°C	Maximum Power Dissipation	125	W
P <sub>D</sub> @ T <sub>C</sub> = 100°C	Maximum Power Dissipation	63	W
	Linear Derating Factor	0.83	W/°C
T <sub>J</sub>	Operating Junction and	-55 to + 175	°C
T <sub>STG</sub>	Storage Temperature Range		
	Soldering Temperature, for 10 seconds (1.6mm from case)		

**Thermal Resistance**

Symbol	Parameter	Typ.	Max.	Units
R <sub>θJC</sub>	Junction-to-Case ⑤	—	1.2	°C/W
R <sub>θJA</sub>	Junction-to-Ambient (PCB Mount) ⑦	—	50	
R <sub>θJA</sub>	Junction-to-Ambient	—	110	

Notes ① through ⑦ are on page 9

**Static @ T<sub>J</sub> = 25°C (unless otherwise specified)**

Symbol	Parameter	Min.	Typ.	Max.	Units	Conditions
BV <sub>DSS</sub>	Drain-to-Source Breakdown Voltage	30	—	—	V	V <sub>GS</sub> = 0V, I <sub>D</sub> = 250μA
ΔBV <sub>DSS</sub> /ΔT <sub>J</sub>	Breakdown Voltage Temp. Coefficient	—	18	—	mV/°C	Reference to 25°C, I <sub>D</sub> = 1mA ②
R <sub>DS(on)</sub>	Static Drain-to-Source On-Resistance	—	1.6	2.2	mΩ	V <sub>GS</sub> = 10V, I <sub>D</sub> = 90A ④
		—	2.6	3.1		V <sub>GS</sub> = 4.5V, I <sub>D</sub> = 72A ④
V <sub>GS(th)</sub>	Gate Threshold Voltage	1.2	1.7	2.2	V	V <sub>DS</sub> = V <sub>GS</sub> , I <sub>D</sub> = 100μA
ΔV <sub>GS(th)</sub> /ΔT <sub>J</sub>	Gate Threshold Voltage Coefficient	—	-7.0	—	mV/°C	
I <sub>DSS</sub>	Drain-to-Source Leakage Current	—	—	1.0	μA	V <sub>DS</sub> = 24 V, V <sub>GS</sub> = 0V
		—	—	150		V <sub>DS</sub> = 24V, V <sub>GS</sub> = 0V, T <sub>J</sub> = 125°C
I <sub>GSS</sub>	Gate-to-Source Forward Leakage	—	—	100	nA	V <sub>GS</sub> = 20V
	Gate-to-Source Reverse Leakage	—	—	-100		V <sub>GS</sub> = -20V
g <sub>fs</sub>	Forward Transconductance	189	—	—	S	V <sub>DS</sub> = 15V, I <sub>D</sub> = 72A
Q <sub>g</sub>	Total Gate Charge	—	36	54	nC	V <sub>DS</sub> = 15V V <sub>GS</sub> = 4.5V I <sub>D</sub> = 72A
Q <sub>gs1</sub>	Pre-V <sub>th</sub> Gate-to-Source Charge	—	10	—		
Q <sub>gs2</sub>	Post-V <sub>th</sub> Gate-to-Source Charge	—	7.7	—		
Q <sub>gd</sub>	Gate-to-Drain Charge	—	10	—		
Q <sub>godr</sub>	Gate Charge Overdrive	—	8.3	—		
Q <sub>sw</sub>	Switch Charge (Q <sub>gs2</sub> + Q <sub>gd</sub> )	—	20	—		
R <sub>G</sub>	Gate Resistance	—	2.0	—		
t <sub>d(on)</sub>	Turn-On Delay Time	—	19	—	ns	V <sub>DD</sub> = 15V I <sub>D</sub> = 72A R <sub>G</sub> = 1.8Ω V <sub>GS</sub> = 4.5V ④
t <sub>r</sub>	Rise Time	—	98	—		
t <sub>d(off)</sub>	Turn-Off Delay Time	—	28	—		
t <sub>f</sub>	Fall Time	—	30	—		
C <sub>iss</sub>	Input Capacitance	—	4945	—	pF	V <sub>GS</sub> = 0V V <sub>DS</sub> = 15V f = 1.0MHz
C <sub>oss</sub>	Output Capacitance	—	908	—		
C <sub>rss</sub>	Reverse Transfer Capacitance	—	493	—		

**Avalanche Characteristics**

E <sub>AS</sub> (Thermally limited)	Single Pulse Avalanche Energy ③	180	mJ
E <sub>AS</sub> (tested)	Single Pulse Avalanche Energy Tested Value ⑥	279	
I <sub>A</sub>	Avalanche Current	72	A

**Diode Characteristics**

Symbol	Parameter	Min.	Typ.	Max.	Units	Conditions
I <sub>S</sub>	Continuous Source Current (Body Diode) ②	—	—	179①	A	MOSFET symbol showing the integral reverse p-n junction diode.
I <sub>SM</sub>	Pulsed Source Current (Body Diode) ②	—	—	357		
V <sub>SD</sub>	Diode Forward Voltage	—	—	1.0	V	T <sub>J</sub> = 25°C, I <sub>S</sub> = 72A, V <sub>GS</sub> = 0V ④
t <sub>rr</sub>	Reverse Recovery Time	—	31	47	ns	T <sub>J</sub> = 25°C I <sub>F</sub> = 72A, V <sub>DD</sub> = 15V
Q <sub>rr</sub>	Reverse Recovery Charge	—	87	130	nC	di/dt = 360A/μs ④

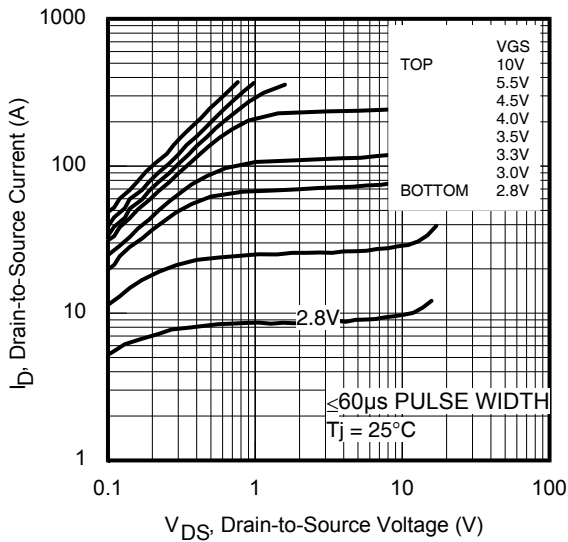
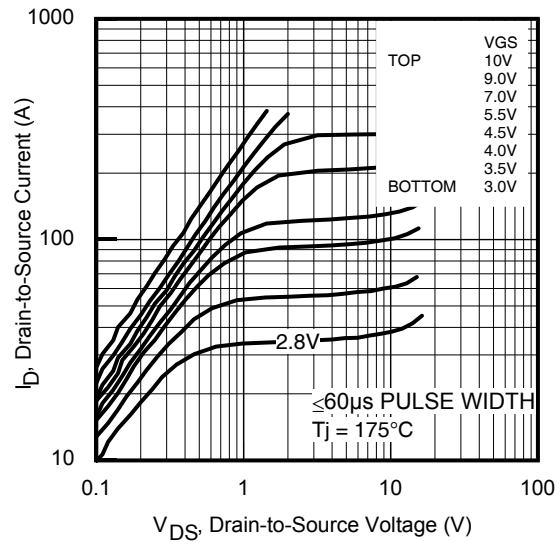
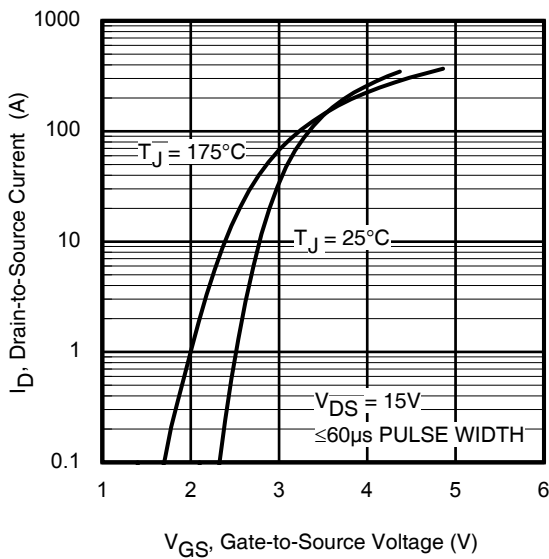
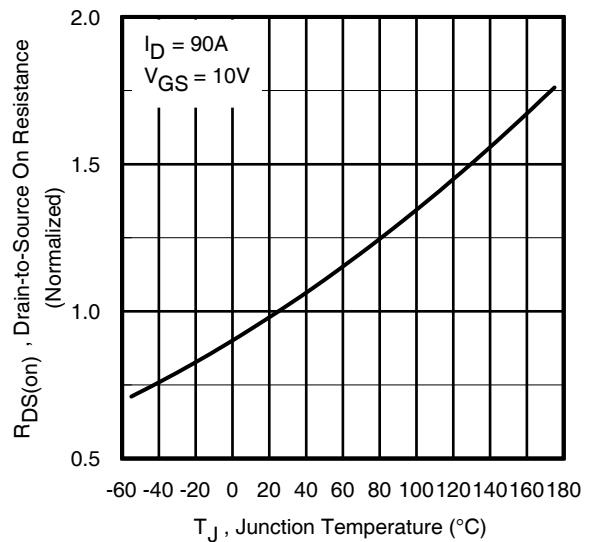
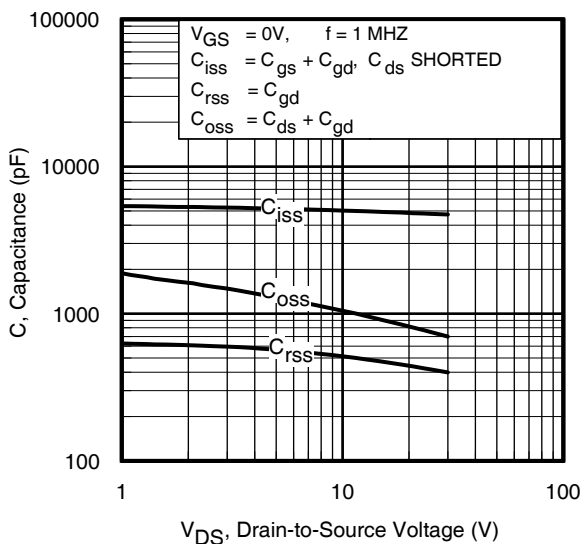
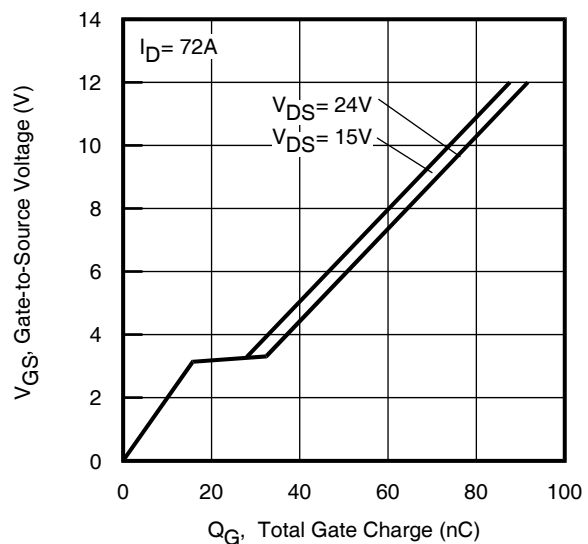
**Fig 1. Typical Output Characteristics**

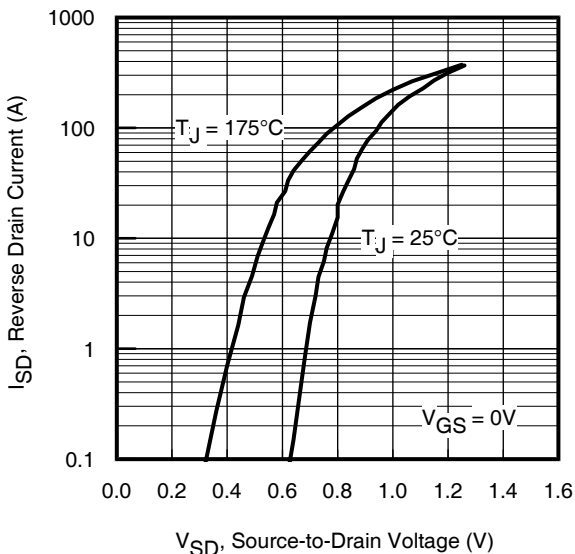
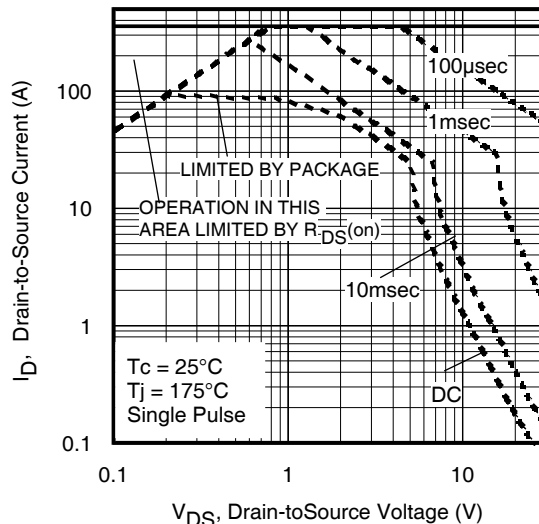
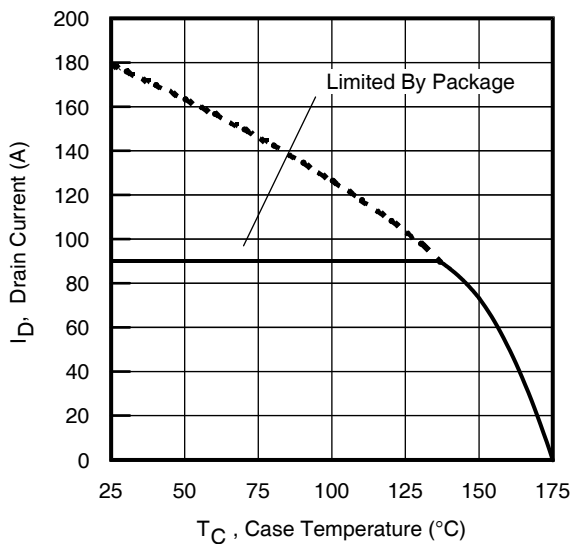
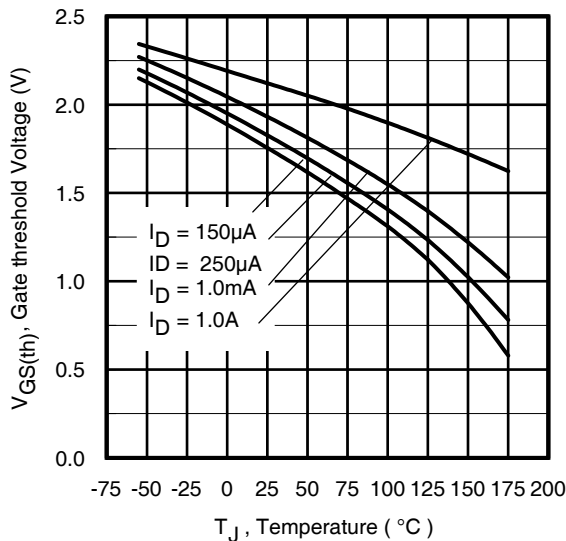
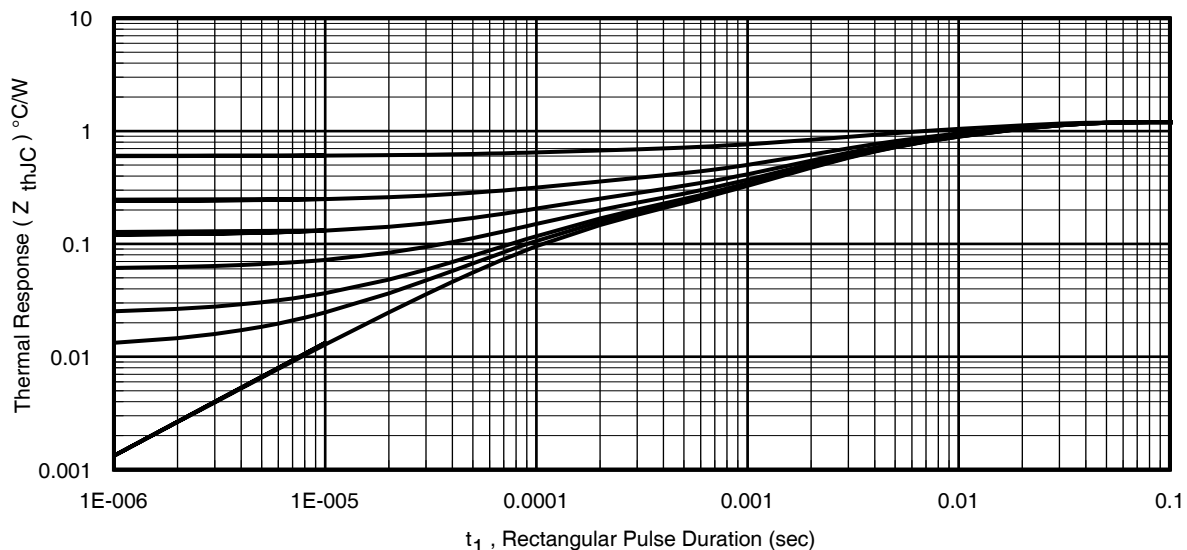
**Fig 2. Typical Output Characteristics**

**Fig 3. Typical Transfer Characteristics**

**Fig 4. Normalized On-Resistance vs. Temperature**

**Fig 5. Typical Capacitance vs. Drain-to-Source Voltage**

**Fig 6. Typical Gate Charge vs. Gate-to-Source Voltage**

**Fig 7.** Typical Source-Drain Diode Forward Voltage

**Fig 8.** Maximum Safe Operating Area

**Fig 9.** Maximum Drain Current vs. Case Temperature

**Fig 10.** Threshold Voltage vs. Temperature

**Fig 11.** Maximum Effective Transient Thermal Impedance, Junction-to-Case

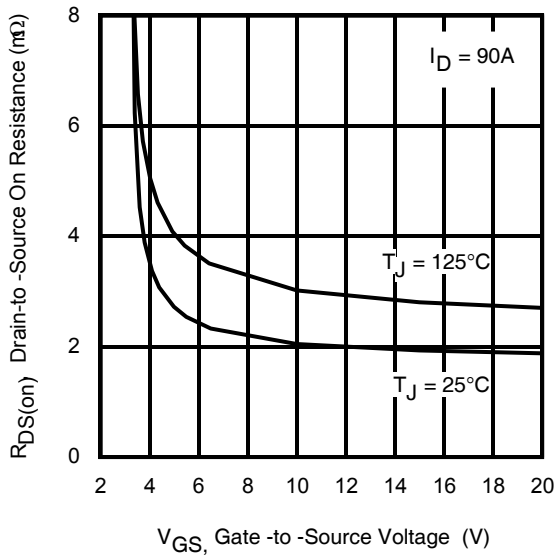

Fig 12. Typical On-Resistance vs. Gate Voltage

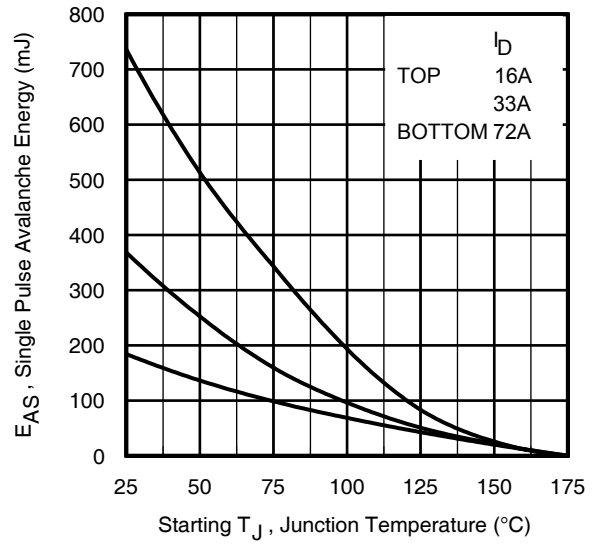

Fig 13. Maximum Avalanche Energy vs. Drain Current

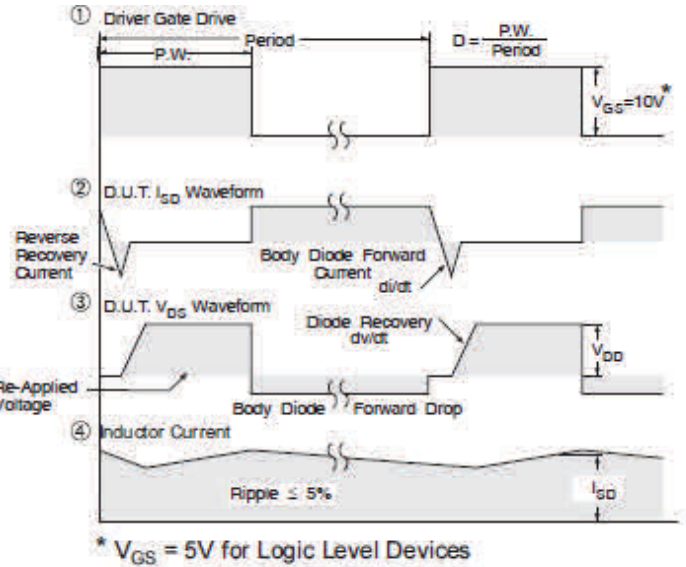
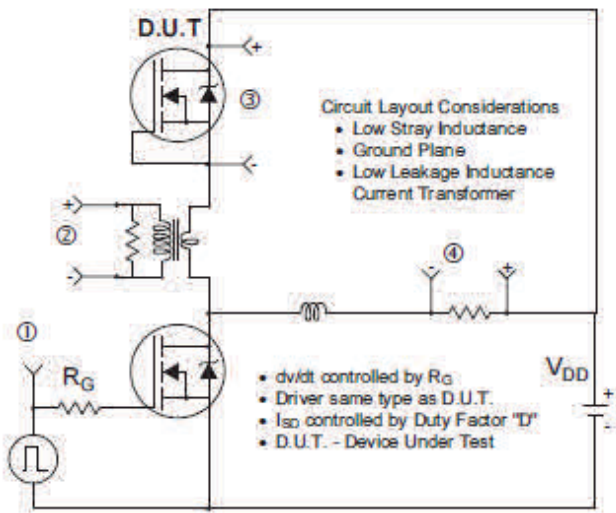

Fig 14. Peak Diode Recovery dv/dt Test Circuit for N-Channel HEXFET® Power MOSFETs

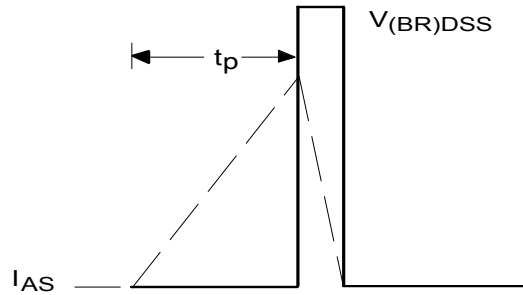
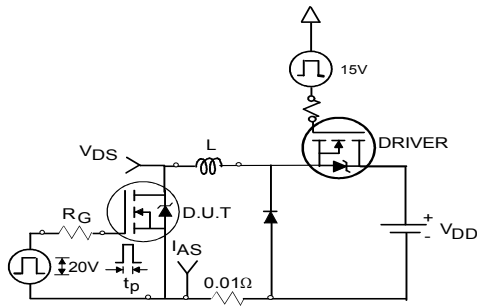

Fig 15a. Unclamped Inductive Test Circuit

Fig 15b. Unclamped Inductive Waveforms

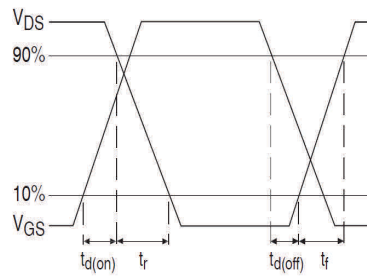
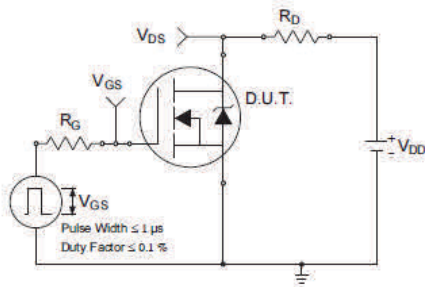

Fig 16a. Switching Time Test Circuit

Fig 16b. Switching Time Waveforms

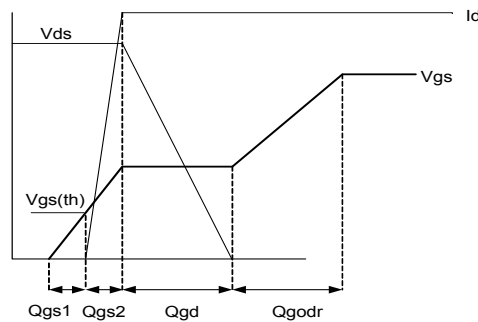
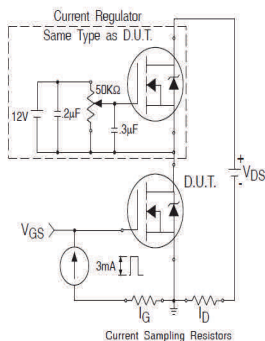
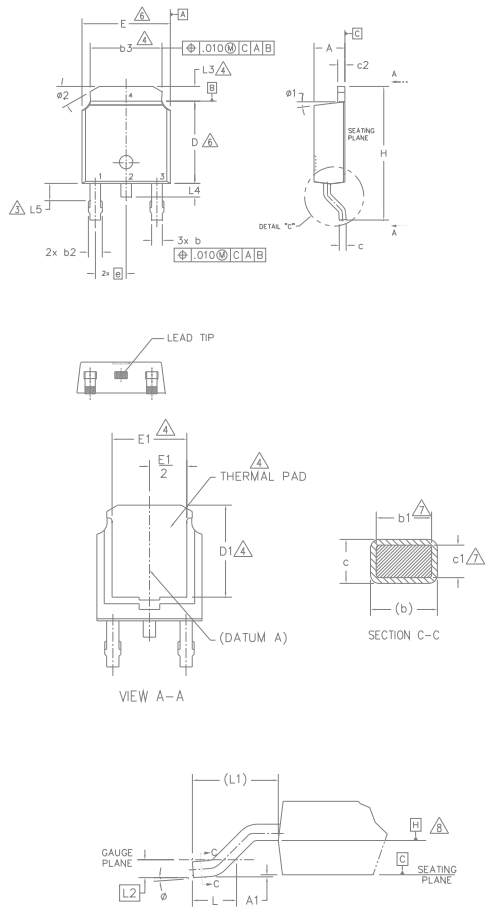

Fig 17a. Gate Charge Test Circuit

Fig 17b. Gate Charge Waveform

## D-Pak (TO-252AA) Package Outline Dimensions are shown in millimeters (inches)



- NOTES:
- 1.- DIMENSIONING AND TOLERANCING PER ASME Y14.5M-1994
  - 2.- DIMENSION ARE SHOWN IN INCHES [MILLIMETERS]
  - 3.- LEAD DIMENSION UNCONTROLLED IN L5.
  - 4.- DIMENSION D1, E1, L3 & b3 ESTABLISH A MINIMUM MOUNTING SURFACE FOR THERMAL PAD.
  - 5.- SECTION C-C DIMENSIONS APPLY TO THE FLAT SECTION OF THE LEAD BETWEEN .005 AND 0.10 [0.13 AND 0.25] FROM THE LEAD TIP.
  - 6.- DIMENSION D & E DO NOT INCLUDE MOLD FLASH. MOLD FLASH SHALL NOT EXCEED .006 [0.15] PER SIDE. THESE DIMENSIONS ARE MEASURED AT THE OUTMOST EXTREMES OF THE PLASTIC BODY.
  - 7.- DIMENSION b1 & c1 APPLIED TO BASE METAL ONLY.
  - 8.- DATUM A & B TO BE DETERMINED AT DATUM PLANE H.
  - 9.- OUTLINE CONFORMS TO JEDEC OUTLINE TO-252AA.

SYMBOL	DIMENSIONS				NOTES
	MILLIMETERS		INCHES		
	MIN.	MAX.	MIN.	MAX.	
A	2.18	2.39	.086	.094	
A1	-	0.13	-	.005	
b	0.64	0.89	.025	.035	
b1	0.64	0.79	.025	.031	7
b2	0.76	1.14	.030	.045	
b3	4.95	5.46	.195	.215	4
c	0.46	0.61	.018	.024	
c1	0.41	0.56	.016	.022	7
c2	0.46	0.89	.018	.035	
D	5.97	6.22	.235	.245	6
D1	5.21	-	.205	-	4
E	6.35	6.73	.250	.265	6
E1	4.32	-	.170	-	4
e	2.29 BSC		.090 BSC		
H	9.40	10.41	.370	.410	
L	1.40	1.78	.055	.070	
L1	2.74 BSC		.108 REF.		
L2	0.51 BSC		.020 BSC		
L3	0.89	1.27	.035	.050	4
L4	-	1.02	-	.040	
L5	1.14	1.52	.045	.060	3
ø	0"	10"	0"	10"	
ø1	0"	15"	0"	15"	
ø2	25"	35"	25"	35"	

### LEAD ASSIGNMENTS

### HEXFET

- 1.- GATE
- 2.- DRAIN
- 3.- SOURCE
- 4.- DRAIN

### IGBT & CoPAK

- 1.- GATE
- 2.- COLLECTOR
- 3.- EMITTER
- 4.- COLLECTOR

## D-Pak (TO-252AA) Part Marking Information

EXAMPLE: THIS IS AN IRFR120  
WITH ASSEMBLY  
LOT CODE 1234  
ASSEMBLED ON WW 16, 2001  
IN THE ASSEMBLY LINE "A"

Note: "P" in assembly line position  
indicates "Lead-Free"

"P̄" in assembly line position indicates  
"Lead-Free" qualification to the consumer-level

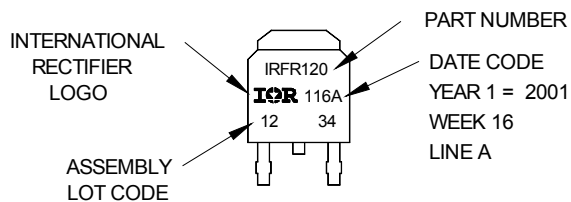

OR

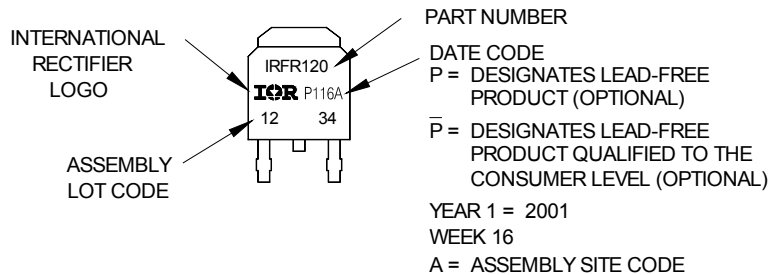

Note: For the most current drawing please refer to IR website at <http://www.irf.com/package/>

D-Pak (TO-252AA) Tape & Reel Information Dimensions are shown in millimeters (inches)

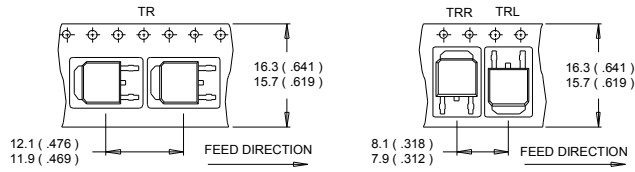

- NOTES :
1. CONTROLLING DIMENSION : MILLIMETER.
  2. ALL DIMENSIONS ARE SHOWN IN MILLIMETERS ( INCHES ).
  3. OUTLINE CONFORMS TO EIA-481 & EIA-541.

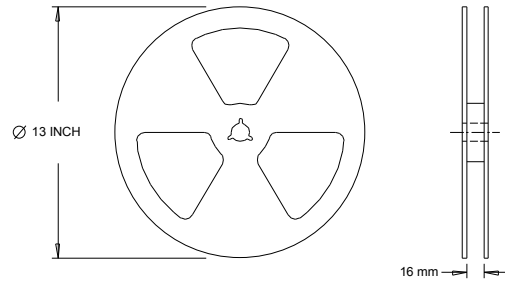

- NOTES :
1. OUTLINE CONFORMS TO EIA-481.

Note: For the most current drawing please refer to IR website at <http://www.irf.com/package/>



**Qualification Information<sup>†</sup>**

<b>Qualification Level</b>	Industrial (per JEDEC JESD47F) <sup>††</sup>	
<b>Moisture Sensitivity Level</b>	D-Pak	MSL1
<b>RoHS Compliant</b>	Yes	

† Qualification standards can be found at International Rectifier’s web site: <http://www.irf.com/product-info/reliability/>

†† Applicable version of JEDEC standard at the time of product release.

**Notes:**

- ① Calculated continuous current based on maximum allowable junction temperature. Bond wire current limit is 90A by source bonding technology. Note that current limitations arising from heating of the device leads may occur with some lead mounting arrangements. (Refer to AN-1140)
- ② Repetitive rating; pulse width limited by max. junction temperature.
- ③ Limited by  $T_{Jmax}$ , starting  $T_J = 25^{\circ}C$ ,  $L = 0.07mH$ ,  $R_G = 50\Omega$ ,  $I_{AS} = 72A$ ,  $V_{GS} = 10V$ .
- ④ Pulse width  $\leq 400\mu s$ ; duty cycle  $\leq 2\%$ .
- ⑤  $R_{\theta}$  is measured at  $T_J$  approximately  $90^{\circ}C$ .
- ⑥ This value determined from sample failure population, starting  $T_J = 25^{\circ}C$ ,  $L=0.07mH$ ,  $R_G = 50\Omega$ ,  $I_{AS} = 72A$ ,  $V_{GS} = 10V$ .
- ⑦ When mounted on 1" square PCB (FR-4 or G-10 Material). For recommended footprint and soldering techniques refer to application note #AN-994. please refer to application note to AN-994: <http://www.irf.com/technical-info/appnotes/an-994.pdf>

**Revision History**

<b>Date</b>	<b>Comments</b>
07/01/2014	The Device is active without bulk part which is removed from Table on page 1

# Mouser Electronics

Authorized Distributor

Click to View Pricing, Inventory, Delivery & Lifecycle Information:

[International Rectifier:](#)

[IRFR8314TRPBF](#)