

Applications

- [RoHS Compliant, Halogen Free](#) ②
- [Lead-Free \(Qualified up to 260°C Reflow\)](#) ①
- Ideal for High Performance Isolated Converter Primary Switch Socket
- Optimized for Synchronous Rectification
- Low Conduction Losses
- High Cdv/dt Immunity
- Low Profile (<0.7mm)
- [Dual Sided Cooling Compatible](#) ①
- [Compatible with existing Surface Mount Techniques](#) ①
- Industrial Qualified

DirectFET™ Power MOSFET ②

Typical values (unless otherwise specified)

V_{DSS}	V_{GS}	R_{DS(on)}
40V min	±20V max	0.70mΩ @ 10V
Q_{g tot}	Q_{gd}	V_{gs(th)}
220nC	81nC	2.8V

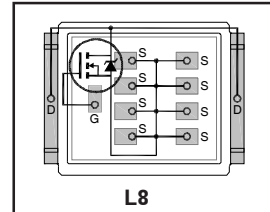

[Applicable DirectFET Outline and Substrate Outline](#) ①

SB	SC		M2	M4		L4	L6	L8	
-----------	-----------	--	-----------	-----------	--	-----------	-----------	-----------	--

Description

The IRF7739L1TRPbF combines the latest HEXFET® Power MOSFET Silicon technology with the advanced DirectFET™ packaging to achieve the lowest on-state resistance in a package that has a footprint smaller than a D²PAK and only 0.7 mm profile. The DirectFET package is compatible with existing layout geometries used in power applications, PCB assembly equipment and vapor phase, infra-red or convection soldering techniques, when [application note AN-1035](#) is followed regarding the manufacturing methods and processes. The DirectFET package allows dual sided cooling to maximize thermal transfer in power systems. The IRF7739L1TRPbF is optimized for high frequency switching and synchronous rectification applications. The reduced total losses in the device coupled with the high level of thermal performance enables high efficiency and low temperatures, which are key for system reliability improvements, and makes this device ideal for high performance power converters.

Ordering Information

Base part number	Package Type	Standard Pack		Orderable Part Number
		Form	Quantity	
IRF7739L1TRPbF	DirectFET Large Can	Tape and Reel	4000	IRF7739L1TRPbF

Absolute Maximum Ratings

	Parameter	Max.	Units
V _{DS}	Drain-to-Source Voltage	40	V
V _{GS}	Gate-to-Source Voltage	±20	
I _D @ T _C = 25°C	Continuous Drain Current, V _{GS} @ 10V (Silicon Limited) ④	270	A
I _D @ T _C = 100°C	Continuous Drain Current, V _{GS} @ 10V (Silicon Limited) ④	190	
I _D @ T _A = 25°C	Continuous Drain Current, V _{GS} @ 10V (Silicon Limited) ③	46	
I _D @ T _C = 25°C	Continuous Drain Current, V _{GS} @ 10V (Package Limited) ④	375	
I _{DM}	Pulsed Drain Current ⑤	1070	
E _{AS}	Single Pulse Avalanche Energy ⑥	270	mJ
I _{AR}	Avalanche Current ⑤	160	A

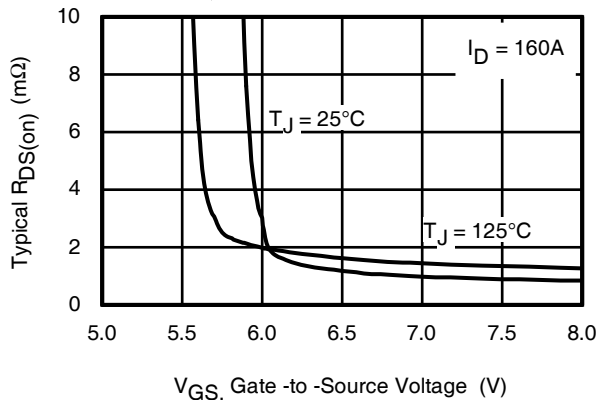

Fig 1. Typical On-Resistance vs. Gate Voltage

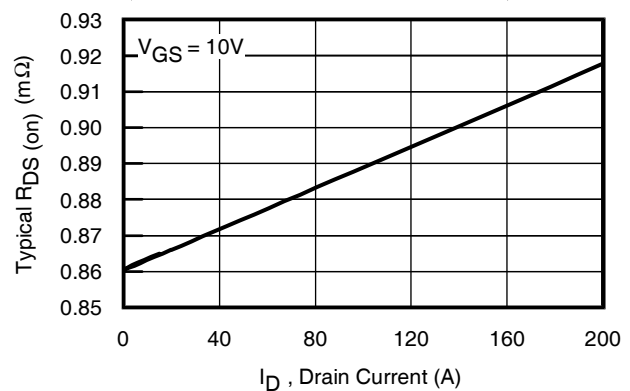

Fig 2. Typical On-Resistance vs. Drain Current

Notes:

- ① Click on the hyperlink (to the relevant technical document) for more details.
- ② Click on the hyperlink (to the DirectFET website) for more details
- ③ Surface mounted on 1 in. square Cu board, steady state.
- ④ T_C measured with thermocouple mounted to top (Drain) of part.
- ⑤ Repetitive rating; pulse width limited by max. junction temperature.
- ⑥ Starting T_J = 25°C, L = 0.021mH, R_G = 25Ω, I_{AS} = 160A.

Static @ $T_J = 25^\circ\text{C}$ (unless otherwise specified)

	Parameter	Min.	Typ.	Max.	Units	Conditions
BV_{DSS}	Drain-to-Source Breakdown Voltage	40	—	—	V	$V_{GS} = 0V, I_D = 250\mu A$
$\Delta BV_{DSS}/\Delta T_J$	Breakdown Voltage Temp. Coefficient	—	0.008	—	V/°C	Reference to $25^\circ\text{C}, I_D = 1.0\text{mA}$
$R_{DS(on)}$	Static Drain-to-Source On-Resistance	—	0.70	1.0	m Ω	$V_{GS} = 10V, I_D = 160A$ ⑦
$V_{GS(th)}$	Gate Threshold Voltage	2.0	2.8	4.0	V	$V_{DS} = V_{GS}, I_D = 250\mu A$
$\Delta V_{GS(th)}/\Delta T_J$	Gate Threshold Voltage Coefficient	—	-6.7	—	mV/°C	
I_{DSS}	Drain-to-Source Leakage Current	—	—	20	μA	$V_{DS} = 40V, V_{GS} = 0V$
		—	—	250		$V_{DS} = 32V, V_{GS} = 0V, T_J = 125^\circ\text{C}$
I_{GSS}	Gate-to-Source Forward Leakage	—	—	100	nA	$V_{GS} = 20V$
	Gate-to-Source Reverse Leakage	—	—	-100		$V_{GS} = -20V$
gfs	Forward Transconductance	280	—	—	S	$V_{DS} = 10V, I_D = 160A$
Q_g	Total Gate Charge	—	220	330	nC	$V_{DS} = 20V$ $V_{GS} = 10V$ $I_D = 160A$ See Fig. 9
Q_{gs1}	Pre-Vth Gate-to-Source Charge	—	46	—		
Q_{gs2}	Post-Vth Gate-to-Source Charge	—	19	—		
Q_{gd}	Gate-to-Drain Charge	—	81	120		
Q_{godr}	Gate Charge Overdrive	—	74	—		
Q_{sw}	Switch Charge ($Q_{gs2} + Q_{gd}$)	—	100	—		
Q_{oss}	Output Charge	—	83	—	nC	$V_{DS} = 16V, V_{GS} = 0V$
R_G	Gate Resistance	—	1.5	—	Ω	
$t_{d(on)}$	Turn-On Delay Time	—	21	—	ns	$V_{DD} = 20V, V_{GS} = 10V$ ⑦ $I_D = 160A$ $R_G = 1.8\Omega$
t_r	Rise Time	—	71	—		
$t_{d(off)}$	Turn-Off Delay Time	—	56	—		
t_f	Fall Time	—	42	—		
C_{iss}	Input Capacitance	—	11880	—	pF	$V_{GS} = 0V$
C_{oss}	Output Capacitance	—	2510	—		$V_{DS} = 25V$
C_{rss}	Reverse Transfer Capacitance	—	1240	—		$f = 1.0\text{MHz}$
C_{oss}	Output Capacitance	—	8610	—		$V_{GS} = 0V, V_{DS} = 1.0V, f = 1.0\text{MHz}$
C_{oss}	Output Capacitance	—	2230	—		$V_{GS} = 0V, V_{DS} = 32V, f = 1.0\text{MHz}$

Diode Characteristics

	Parameter	Min.	Typ.	Max.	Units	Conditions
I_S	Continuous Source Current (Body Diode)	—	—	110	A	MOSFET symbol showing the integral reverse p-n junction diode.
I_{SM}	Pulsed Source Current (Body Diode) ⑤	—	—	1070		
V_{SD}	Diode Forward Voltage	—	—	1.3	V	$T_J = 25^\circ\text{C}, I_S = 160A, V_{GS} = 0V$ ⑦
t_{rr}	Reverse Recovery Time	—	87	130	ns	$T_J = 25^\circ\text{C}, I_F = 160A, V_{DD} = 20V$
Q_{rr}	Reverse Recovery Charge	—	250	380	nC	$di/dt = 100A/\mu s$ ⑦

Notes:

⑤ Repetitive rating; pulse width limited by max. junction temperature.

 ⑦ Pulse width $\leq 400\mu s$; duty cycle $\leq 2\%$.

Absolute Maximum Ratings

	Parameter	Max.	Units
$P_D @ T_C = 25^\circ\text{C}$	Power Dissipation ④	125	W
$P_D @ T_C = 100^\circ\text{C}$	Power Dissipation ④	63	
$P_D @ T_A = 25^\circ\text{C}$	Power Dissipation ①	3.8	
T_P	Peak Soldering Temperature	270	°C
T_J	Operating Junction and	-55 to + 175	
T_{STG}	Storage Temperature Range		

Thermal Resistance

	Parameter	Typ.	Max.	Units
$R_{\theta JA}$	Junction-to-Ambient ③	—	40	°C/W
$R_{\theta JA}$	Junction-to-Ambient ③	12.5	—	
$R_{\theta JA}$	Junction-to-Ambient ⑨	20	—	
$R_{\theta J-Can}$	Junction-to-Can ④⑩	—	1.2	
$R_{\theta J-PCB}$	Junction-to-PCB Mounted	—	0.4	

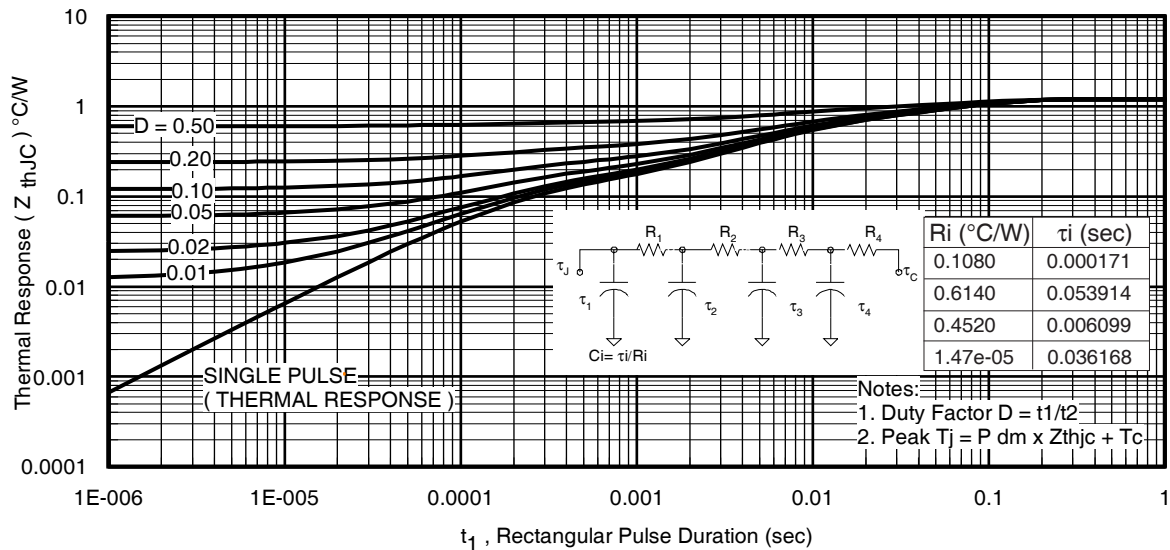
Fig 3. Maximum Effective Transient Thermal Impedance, Junction-to-Case ④
Notes:

- ③ Surface mounted on 1 in. square Cu board, steady state.
- ④ T_C measured with thermocouple incontact with top (Drain) of part.
- ⑤ Used double sided cooling, mounting pad with large heatsink.
- ⑨ Mounted on minimum footprint full size board with metalized back and with small clip heatsink.
- ⑩ R_{θ} is measured at T_J of approximately 90°C .

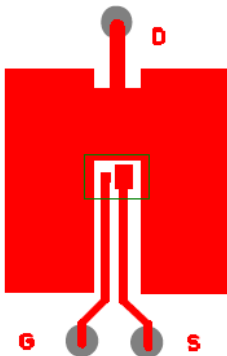

③ Surface mounted on 1 in. square Cu board (still air).

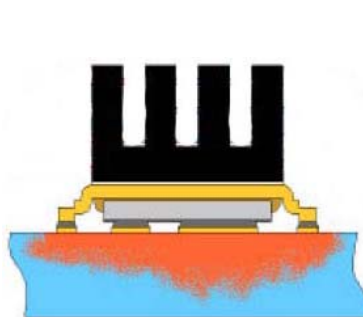

⑨ Mounted on minimum footprint full size board with metalized back and with small clip heatsink. (still air)

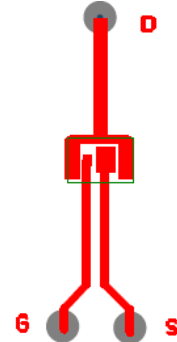

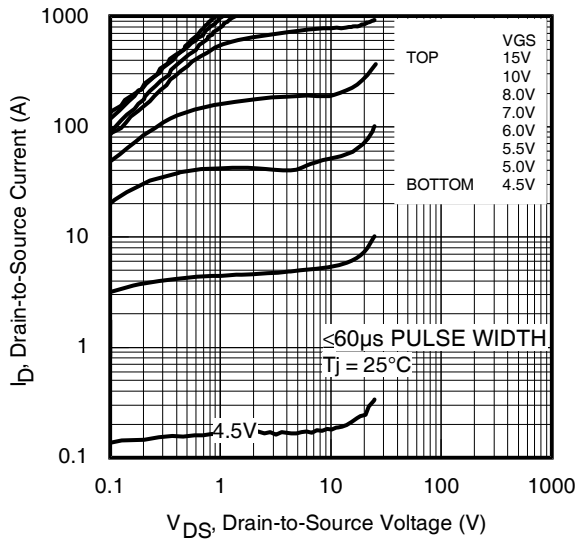
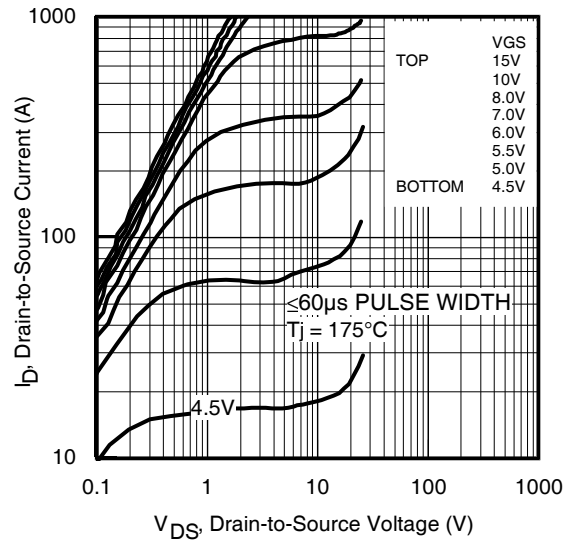
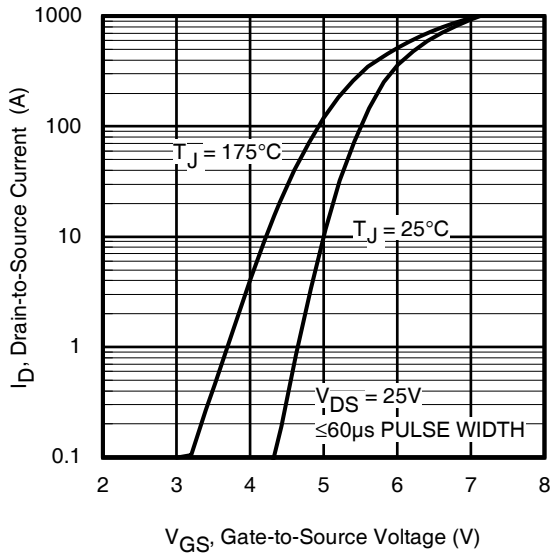
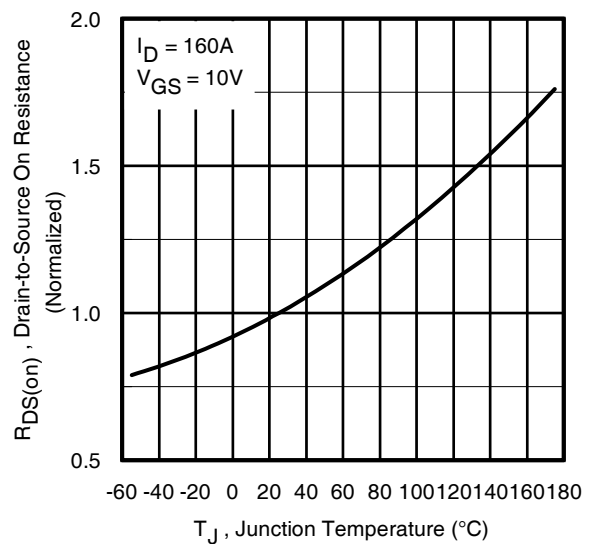
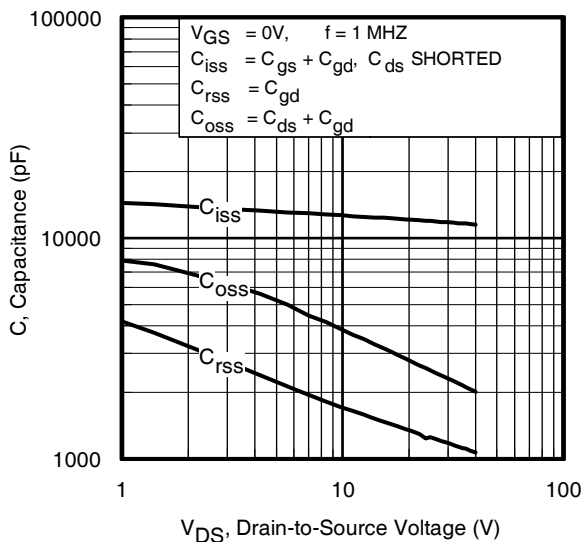
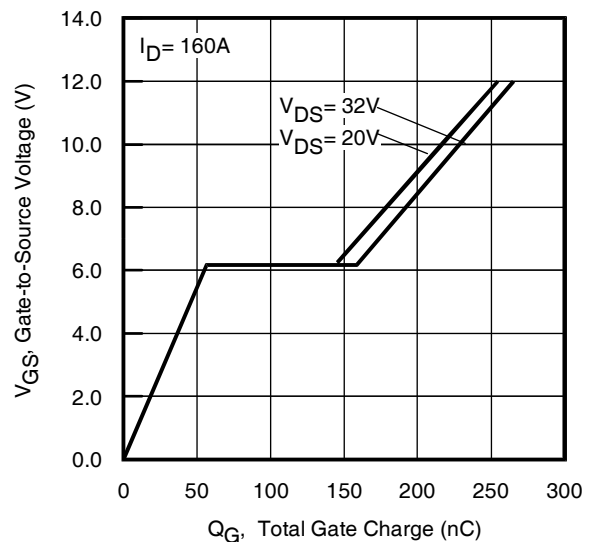
Fig 4. Typical Output Characteristics

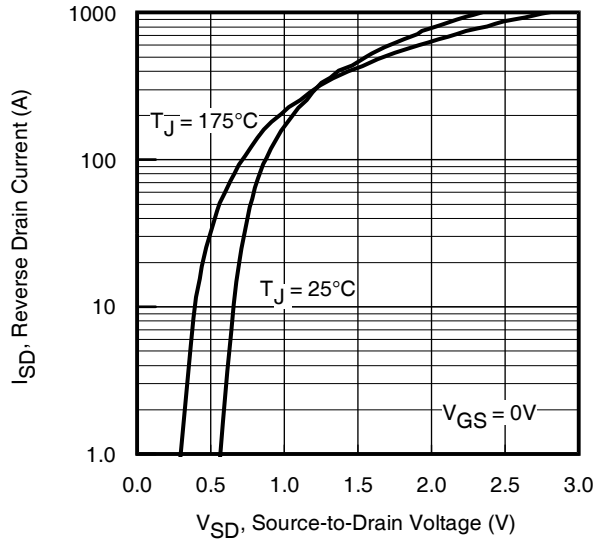
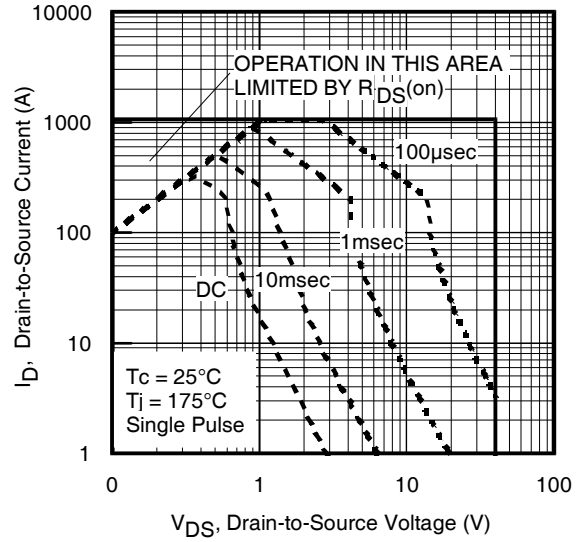
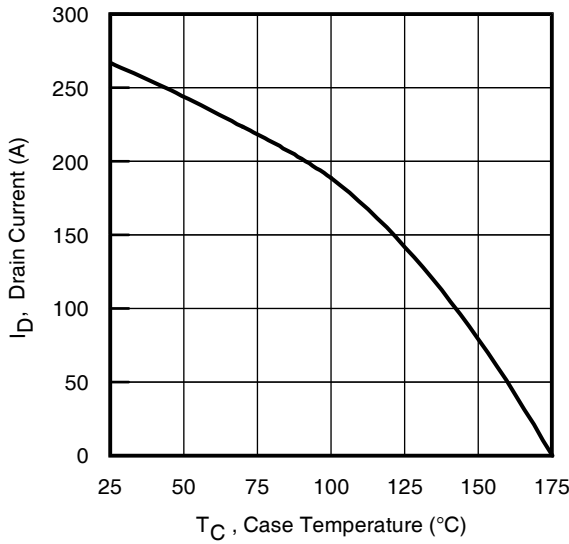
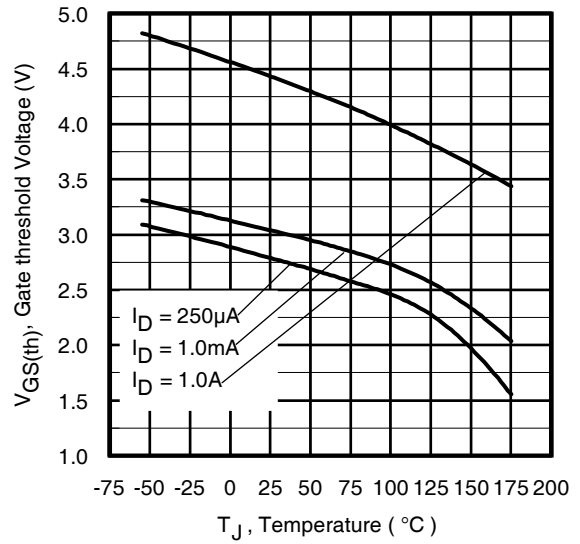
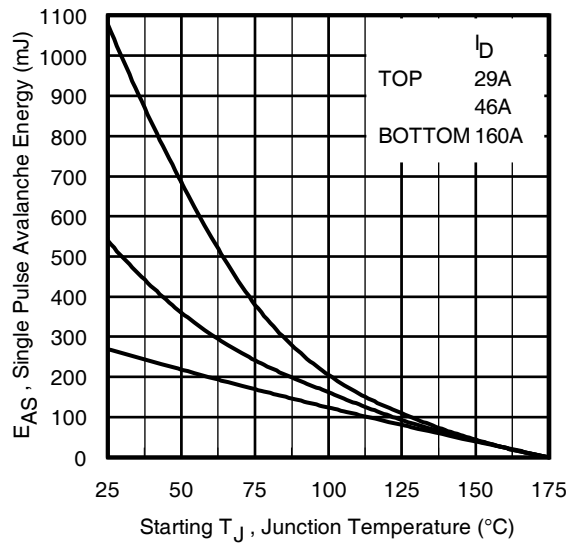
Fig 5. Typical Output Characteristics

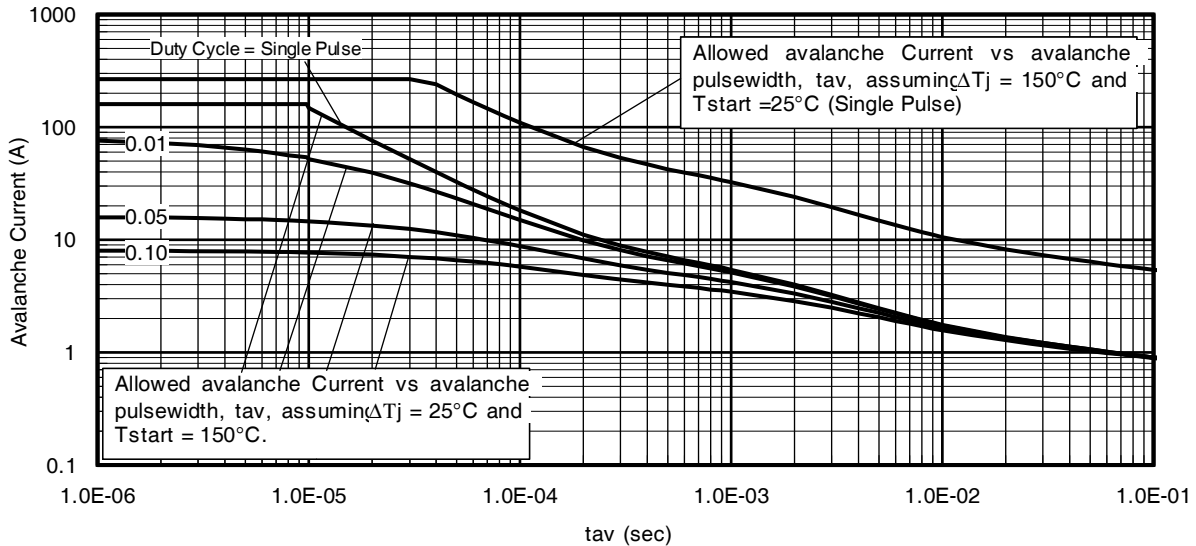
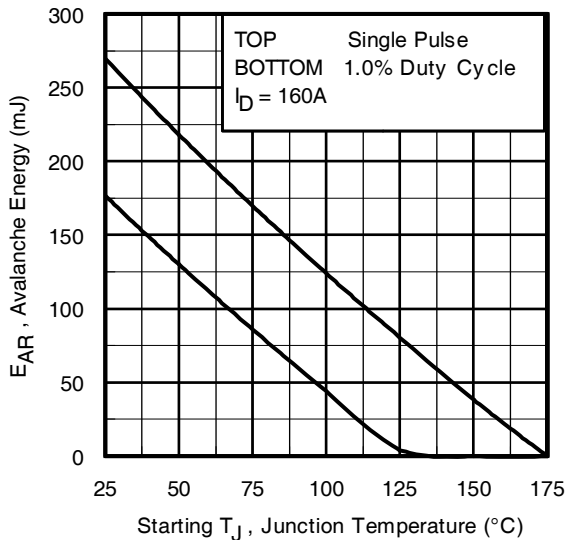
Fig 6. Typical Transfer Characteristics

Fig 7. Normalized On-Resistance vs. Temperature

Fig 8. Typical Capacitance vs. Drain-to-Source Voltage

Fig 9. Typical Total Gate Charge vs. Gate-to-Source Voltage

Fig 10. Typical Source-Drain Diode Forward Voltage

Fig11. Maximum Safe Operating Area

Fig 12. Maximum Drain Current vs. Case Temperature

Fig 13. Typical Threshold Voltage vs. Junction Temperature

Fig 14. Maximum Avalanche Energy vs. Drain Current

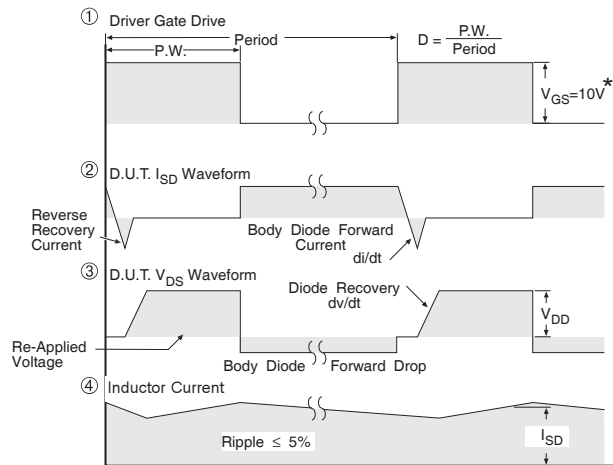
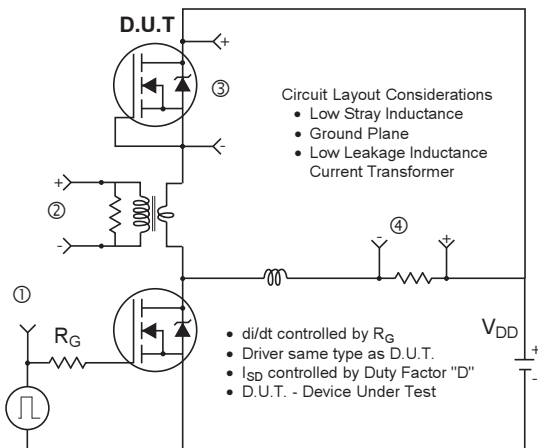

Fig 15. Typical Avalanche Current vs. Pulsewidth

Fig 16. Maximum Avalanche Energy vs. Temperature
Notes on Repetitive Avalanche Curves, Figures 15, 16:
(For further info, see AN-1005)

1. Avalanche failures assumption:
Purely a thermal phenomenon and failure occurs at a temperature far in excess of T_{jmax} . This is validated for every part type.
2. Safe operation in Avalanche is allowed as long as T_{jmax} is not exceeded.
3. Equation below based on circuit and waveforms shown in Figures 19a, 19b.
4. $P_{D(ave)}$ = Average power dissipation per single avalanche pulse.
5. BV = Rated breakdown voltage (1.3 factor accounts for voltage increase during avalanche).
6. I_{av} = Allowable avalanche current.
7. ΔT = Allowable rise in junction temperature, not to exceed T_{jmax} (assumed as 25°C in Figure 15, 16).
 t_{av} = Average time in avalanche.
 D = Duty cycle in avalanche = $t_{av} \cdot f$
 $Z_{thJC}(D, t_{av})$ = Transient thermal resistance, see figure 11)

$$P_{D(ave)} = 1/2 (1.3 \cdot BV \cdot I_{av}) = \Delta T / Z_{thJC}$$

$$I_{av} = 2\Delta T / [1.3 \cdot BV \cdot Z_{thJC}]$$

$$E_{AS(AR)} = P_{D(ave)} \cdot t_a$$



* $V_{GS} = 5V$ for Logic Level Devices

Fig 17. Diode Reverse Recovery Test Circuit for N-Channel HEXFET® Power MOSFETs

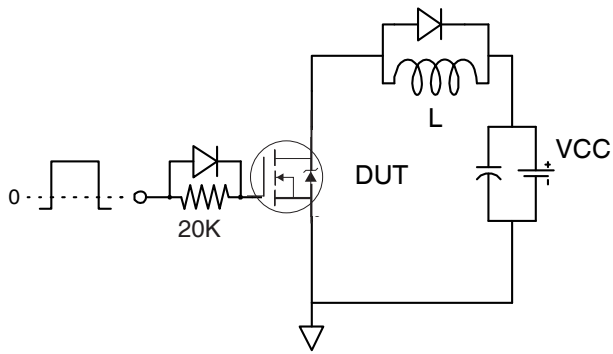

Fig 18a. Gate Charge Test Circuit

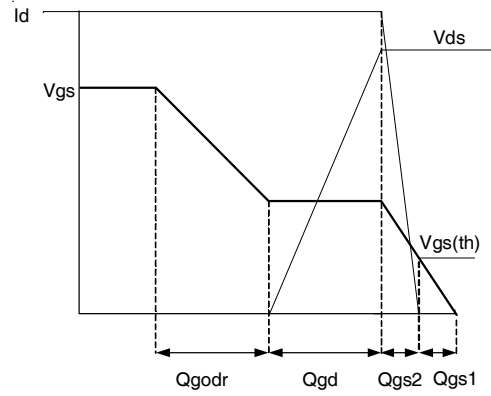

Fig 18b. Gate Charge Waveform



Fig 19a. Unclamped Inductive Test Circuit

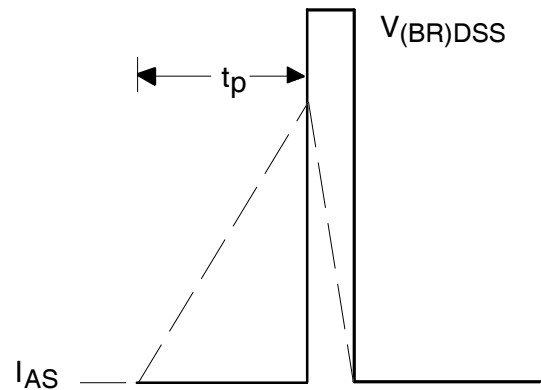

Fig 19b. Unclamped Inductive Waveforms



Fig 20a. Switching Time Test Circuit

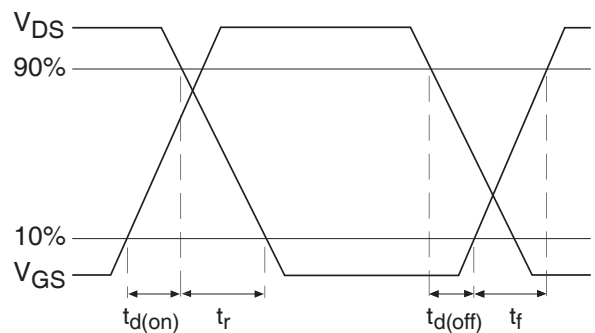
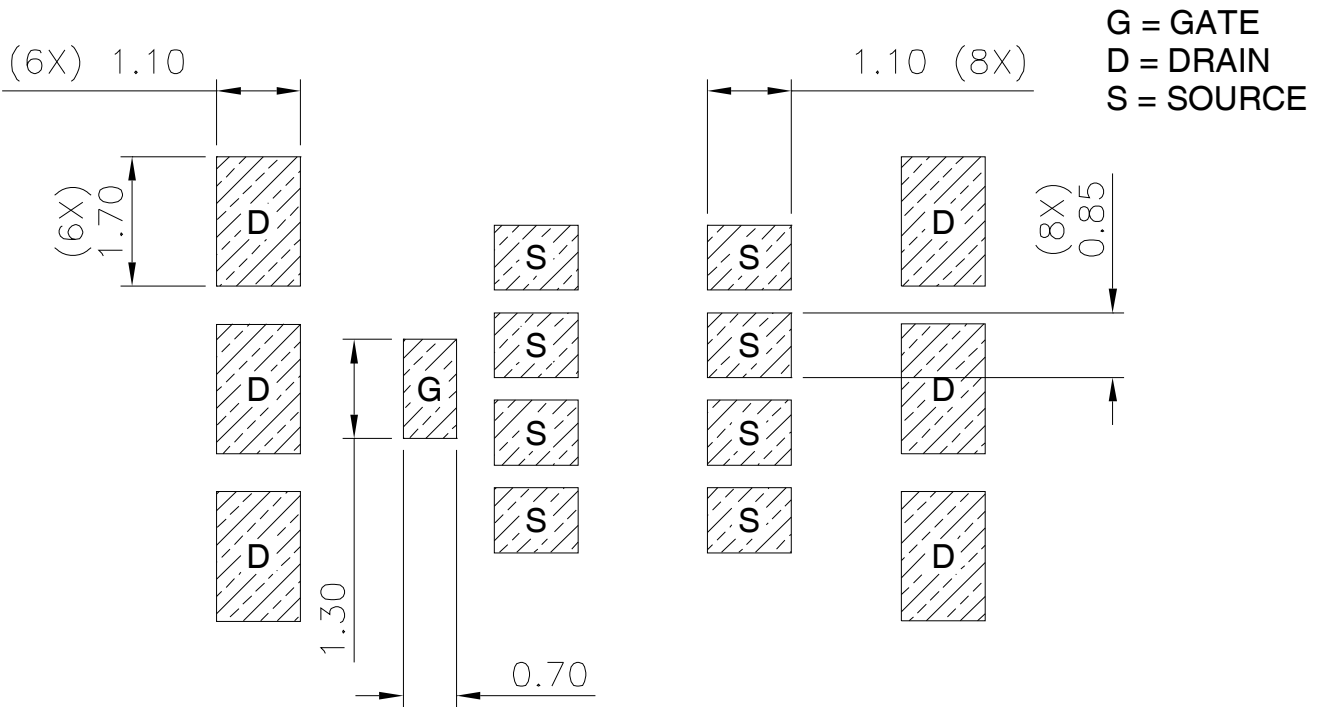
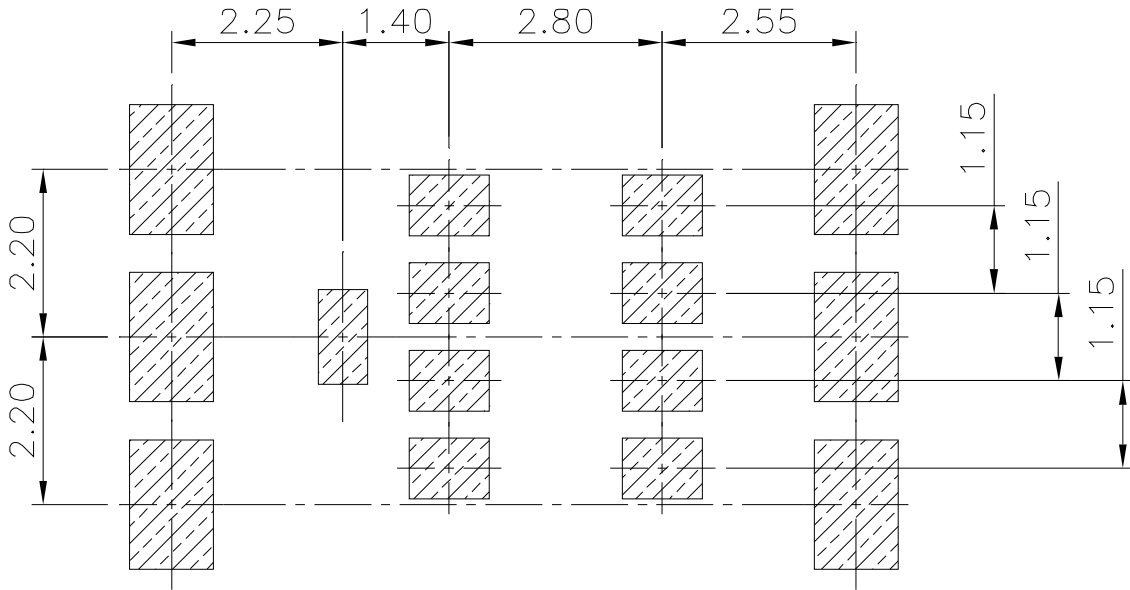

Fig 20b. Switching Time Waveforms

DirectFET™ Board Footprint, L8 (Large Size Can).

 Please see [AN-1035](#) for DirectFET assembly details and stencil and substrate design recommendations

 Note: For the most current drawing please refer to IR website at <http://www.irf.com/package/>

DirectFET™ Outline Dimension, L8 Outline (LargeSize Can).

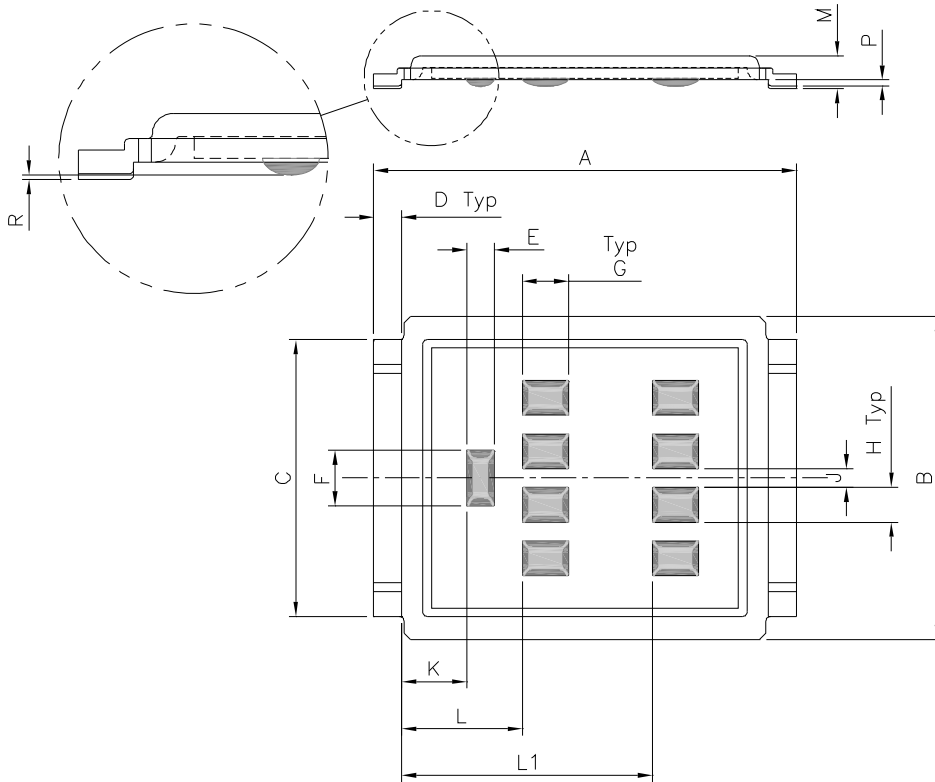
Please see [AN-1035](#) for DirectFET assembly details and stencil and substrate design recommendations



CODE	METRIC		IMPERIAL	
	MIN	MAX	MIN	MAX
A	9.05	9.15	0.356	0.360
B	6.85	7.10	0.270	0.280
C	5.90	6.00	0.232	0.236
D	0.55	0.65	0.022	0.026
E	0.58	0.62	0.023	0.024
F	1.18	1.22	0.046	0.048
G	0.98	1.02	0.039	0.040
H	0.73	0.77	0.029	0.030
J	0.38	0.42	0.015	0.017
K	1.35	1.45	0.053	0.057
L	2.55	2.65	0.100	0.104
L1	5.35	5.45	0.211	0.215
M	0.68	0.74	0.027	0.029
P	0.09	0.17	0.003	0.007
R	0.02	0.08	0.001	0.003

DirectFET™ Part Marking

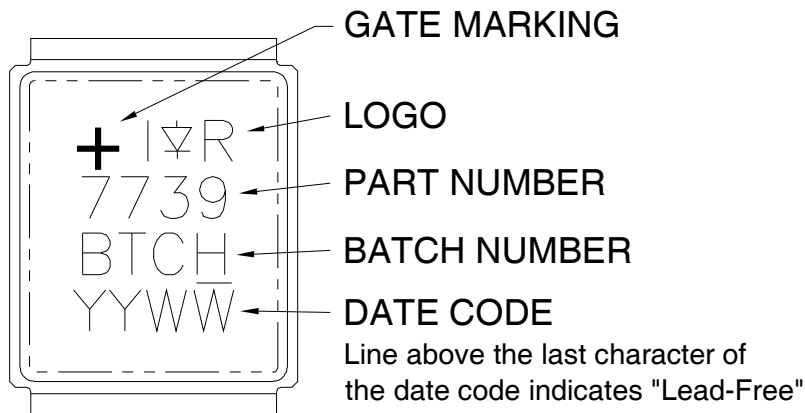

Note: For the most current drawing please refer to IR website at <http://www.irf.com/package/>

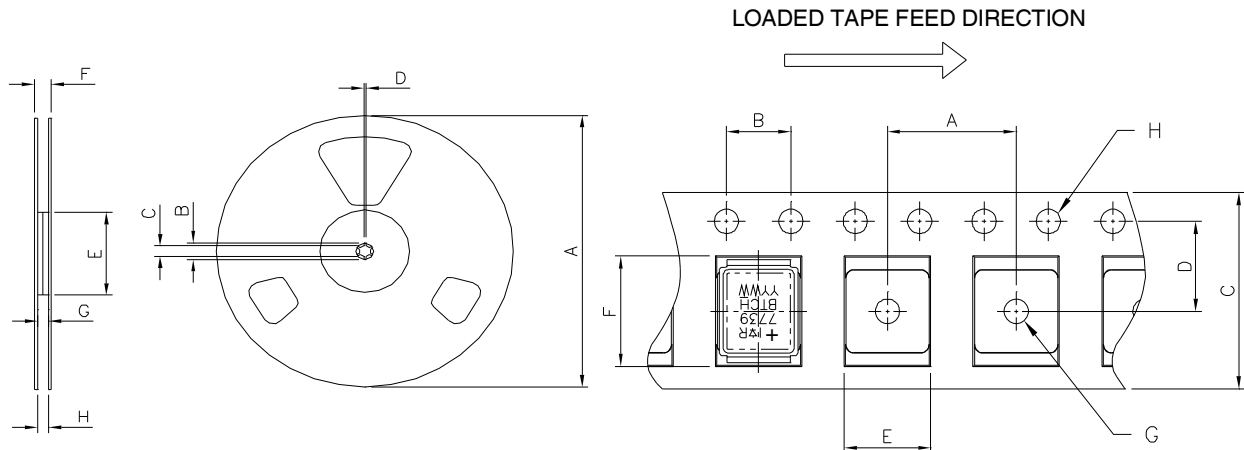
DirectFET™ Tape & Reel Dimension (Showing component orientation).

NOTE: Controlling dimensions in mm
Std reel quantity is 4000 parts. (ordered as IRF7739L1TRPbF).

REEL DIMENSIONS				
STANDARD OPTION (QTY 4000)				
CODE	METRIC		IMPERIAL	
	MIN	MAX	MIN	MAX
A	330.00	N.C	12.992	N.C
B	20.20	N.C	0.795	N.C
C	12.80	13.20	0.504	0.520
D	1.50	N.C	0.059	N.C
E	99.00	100.00	3.900	3.940
F	N.C	22.40	N.C	0.880
G	16.40	18.40	0.650	0.720
H	15.90	19.40	0.630	0.760

NOTE: CONTROLLING DIMENSIONS IN MM

CODE	DIMENSIONS			
	METRIC		IMPERIAL	
	MIN	MAX	MIN	MAX
A	11.90	12.10	4.69	0.476
B	3.90	4.10	0.154	0.161
C	15.90	16.30	0.623	0.642
D	7.40	7.60	0.291	0.299
E	7.20	7.40	0.283	0.291
F	9.90	10.10	0.390	0.398
G	1.50	N.C	0.059	N.C
H	1.50	1.60	0.059	0.063

Note: For the most current drawing please refer to IR website at <http://www.irf.com/package/>

Qualification Information†

Qualification level	Industrial ††*	
Moisture Sensitivity Level	DirectFET	MSL1 (per JEDEC J-STD-020D†††)
RoHS Compliant	Yes	

† Qualification standards can be found at International Rectifier's web site

<http://www.irf.com/product-info/reliability>

†† Higher qualification ratings may be available should the user have such requirements.

Please contact your International Rectifier sales representative for further information:

<http://www.irf.com/whoto-call/salesrep/>

††† Applicable version of JEDEC standard at the time of product release.

* Industrial qualification standards except autoclave test conditions

Revision History

Date	Comments
2/12/2013	TR1 option removed and Tape & Reel Info updated accordingly. Hyperlinks added throw-out the document

Mouser Electronics

Authorized Distributor

Click to View Pricing, Inventory, Delivery & Lifecycle Information:

[International Rectifier:](#)

[IRF7739L1TRPBF](#)