

# High Voltage MOSFET

N-Channel, Enhancement Mode

**IXTU 01N100**

**IXTY 01N100**

$V_{DSS} = 1000 \text{ V}$

$I_{D25} = 100 \text{ mA}$

$R_{DS(on)} = 80 \ \Omega$

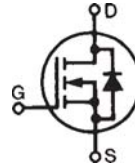

Symbol	Test Conditions	Maximum Ratings 01N100	
$V_{DSS}$	$T_J = 25^\circ\text{C}$ to $150^\circ\text{C}$	1000	V
$V_{DGR}$	$T_J = 25^\circ\text{C}$ to $150^\circ\text{C}$ ; $R_{GS} = 1 \text{ M}\Omega$	1000	V
$V_{GS}$	Continuous	$\pm 20$	V
$V_{GSM}$	Transient	$\pm 30$	V
$I_{D25}$	$T_C = 25^\circ\text{C}$ ; $T_J = 25^\circ\text{C}$ to $150^\circ\text{C}$	100	mA
$I_{DM}$	$T_C = 25^\circ\text{C}$ , pulse width limited by max. $T_J$	400	mA
$P_D$	$T_C = 25^\circ\text{C}$	25	W
$T_J$		-55 ... +150	$^\circ\text{C}$
$T_{JM}$		150	$^\circ\text{C}$
$T_{stg}$		-55 ... +150	$^\circ\text{C}$
$T_L$	1.6 mm (0.063 in) from case for 5 s	300	$^\circ\text{C}$
<b>Weight</b>		0.8	g

TO-251 AA (IXTU)

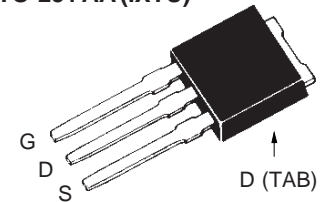

TO-252 AA (IXTY)

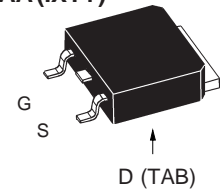

G = Gate, D = Drain,  
S = Source, TAB = Drain

Symbol	Test Conditions	Characteristic Values ( $T_J = 25^\circ\text{C}$ , unless otherwise specified)		
		min.	typ.	max.
$V_{DSS}$	$V_{GS} = 0 \text{ V}$ , $I_D = 25 \ \mu\text{A}$	1000		V
$V_{GS(th)}$	$V_{DS} = V_{GS}$ , $I_D = 25 \ \mu\text{A}$	2		4.5 V
$I_{GSS}$	$V_{GS} = \pm 20 \text{ V}_{DC}$ , $V_{DS} = 0$			$\pm 50 \text{ nA}$
$I_{DSS}$	$V_{DS} = 0.8 \cdot V_{DSS}$ , $T_J = 25^\circ\text{C}$ $V_{GS} = 0 \text{ V}$ , $T_J = 125^\circ\text{C}$			10 $\mu\text{A}$ 200 $\mu\text{A}$
$R_{DS(on)}$	$V_{GS} = 10 \text{ V}$ , $I_D = I_{D25}$ Pulse test, $t \leq 300 \text{ ms}$ , duty cycle $d \leq 2 \%$		60	80 $\Omega$

## Features

- International standard packages JEDEC TO-251 AA, TO-252 AA
- Low  $R_{DS(on)}$  HDMOS™ process
- Rugged polysilicon gate cell structure
- Fast switching times

## Applications

- Level shifting
- Triggers
- Solid state relays
- Current regulators

Symbol	Test Conditions	Characteristic Values		
		(T <sub>J</sub> = 25°C, unless otherwise specified)		
		min.	typ.	max.
<b>g<sub>fs</sub></b>	V <sub>DS</sub> = 10 V; I <sub>D</sub> = 0.5 • I <sub>D25</sub> , pulse test		160	mS
<b>C<sub>iss</sub></b>	V <sub>GS</sub> = 0 V, V <sub>DS</sub> = 25 V, f = 1 MHz		54	pF
<b>C<sub>oss</sub></b>			6.9	pF
<b>C<sub>rss</sub></b>			2	pF
<b>t<sub>d(on)</sub></b>	V <sub>GS</sub> = 10 V, V <sub>DS</sub> = 500 V, I <sub>D</sub> = I <sub>D25</sub> R <sub>G</sub> = 50 Ω (External)		12	ns
<b>t<sub>r</sub></b>			12	ns
<b>t<sub>d(off)</sub></b>			28	ns
<b>t<sub>f</sub></b>			28	ns
<b>Q<sub>g(on)</sub></b>	V <sub>GS</sub> = 10 V, V <sub>DS</sub> = 0.5 • V <sub>DSS</sub> , I <sub>D</sub> = 0.5 I <sub>D25</sub>		6.9	nC
<b>Q<sub>gs</sub></b>			1.8	nC
<b>Q<sub>gd</sub></b>			3.0	nC
<b>R<sub>thJC</sub></b>			5	K/W

### Source-Drain Diode

Symbol	Test Conditions	Characteristic Values		
		(T <sub>J</sub> = 25°C, unless otherwise specified)		
		min.	typ.	max.
<b>V<sub>SD</sub></b>	I <sub>F</sub> = 100 mA, V <sub>GS</sub> = 0 V, Pulse test, t ≤ 300 μs, duty cycle d ≤ 2 %			1.8 V
<b>t<sub>rr</sub></b>	I <sub>F</sub> = 0.75 A, -di/dt = 10 A/μs, V <sub>DS</sub> = 25 V			1.5 μs

### TO-251 AA Outline

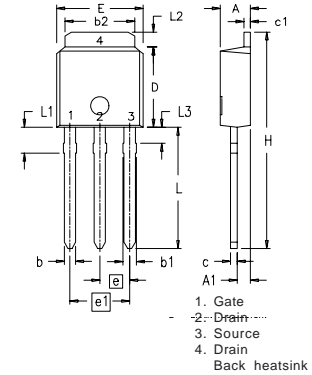

Dim.	Millimeter		Inches	
	Min.	Max.	Min.	Max.
A	2.19	2.38	.086	.094
A1	0.89	1.14	0.35	.045
b	0.64	0.89	.025	.035
b1	0.76	1.14	.030	.045
b2	5.21	5.46	.205	.215
c	0.46	0.58	.018	.023
c1	0.46	0.58	.018	.023
D	5.97	6.22	.235	.245
E	6.35	6.73	.250	.265
e	2.28	BSC	.090	BSC
e1	4.57	BSC	.180	BSC
H	17.02	17.78	.670	.700
L	8.89	9.65	.350	.380
L1	1.91	2.28	.075	.090
L2	0.89	1.27	.035	.050
L3	1.15	1.52	.045	.060

### TO-252 AA

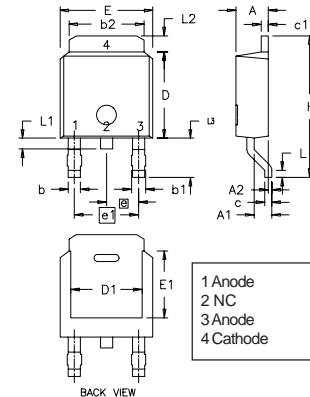

Dim.	Millimeter		Inches	
	Min.	Max.	Min.	Max.
A	2.19	2.38	0.086	0.094
A1	0.89	1.14	0.035	0.045
A2	0	0.13	0	0.005
b	0.64	0.89	0.025	0.035
b1	0.76	1.14	0.030	0.045
b2	5.21	5.46	0.205	0.215
c	0.46	0.58	0.018	0.023
c1	0.46	0.58	0.018	0.023
D	5.97	6.22	0.235	0.245
D1	4.32	5.21	0.170	0.205
E	6.35	6.73	0.250	0.265
E1	4.32	5.21	0.170	0.205
e	2.28	BSC	0.090	BSC
e1	4.57	BSC	0.180	BSC
H	9.40	10.42	0.370	0.410
L	0.51	1.02	0.020	0.040
L1	0.64	1.02	0.025	0.040
L2	0.89	1.27	0.035	0.050
L3	2.54	2.92	0.100	0.115

IXYS reserves the right to change limits, test conditions, and dimensions.

**Fig. 1. Output Characteristics**  
@ 25°C

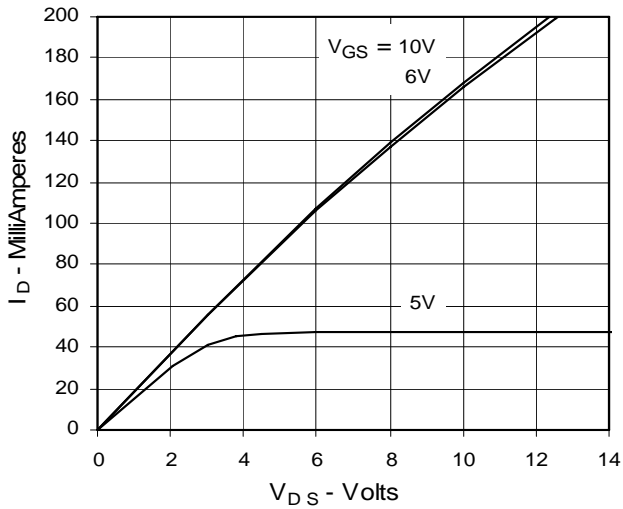

**Fig. 2. Extended Output Characteristics**  
@ 25°C

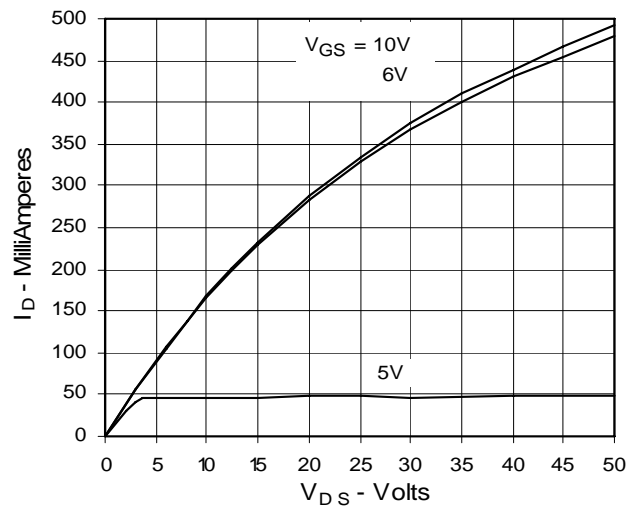

**Fig. 3. Output Characteristics**  
@ 125°C

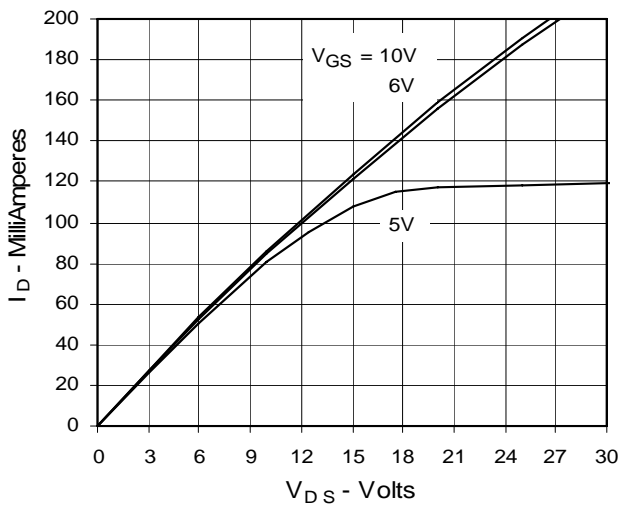

**Fig. 4.  $R_{DS(on)}$  Normalized to 0.5  $I_{D25}$  Value vs. Junction Temperature**

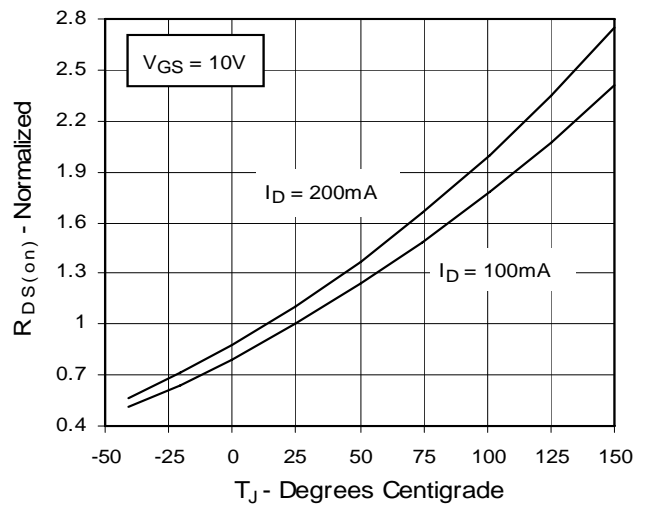

**Fig. 5.  $R_{DS(on)}$  Normalized to 0.5  $I_{D25}$  Value vs.  $I_D$**

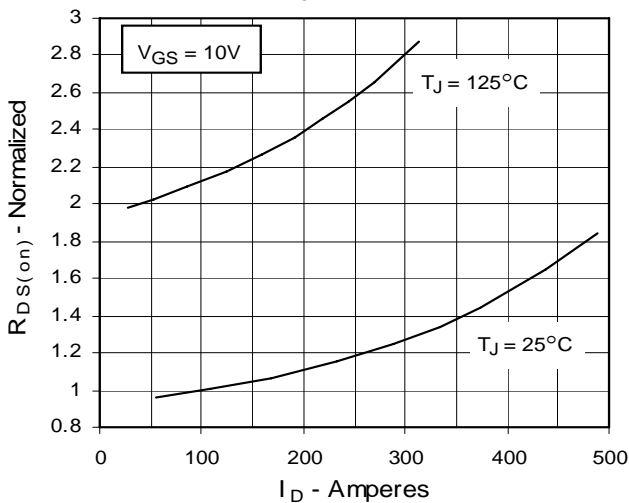

**Fig. 6. Drain Current vs. Case Temperature**

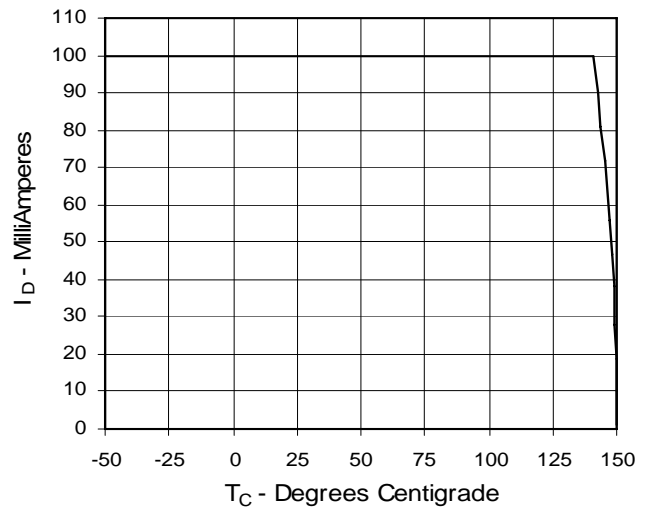

**Fig. 7. Input Admittance**

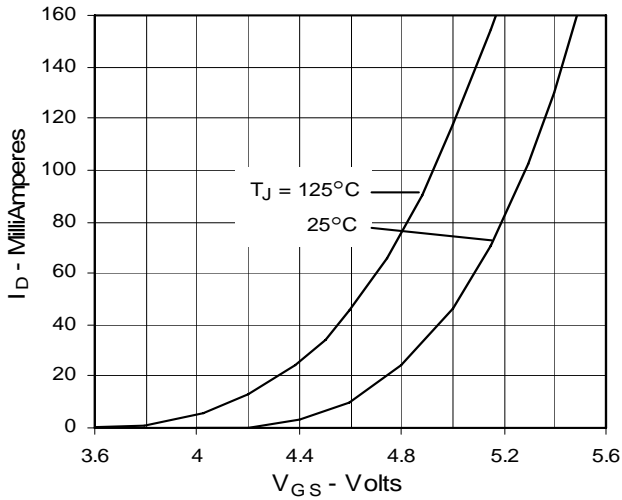

**Fig. 8. Transconductance**

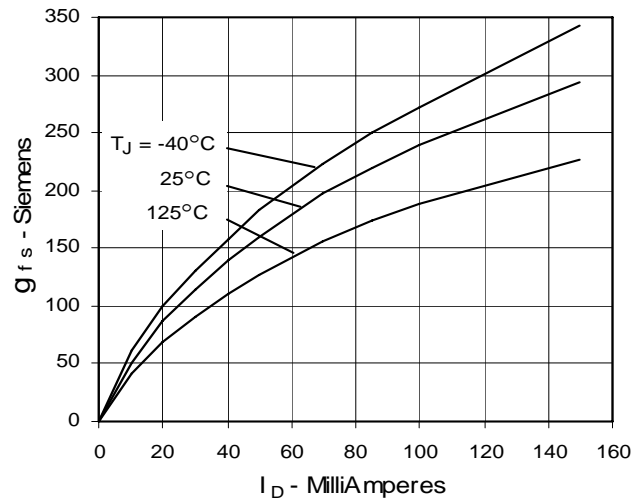

**Fig. 9. Source Current vs. Source-To-Drain Voltage**

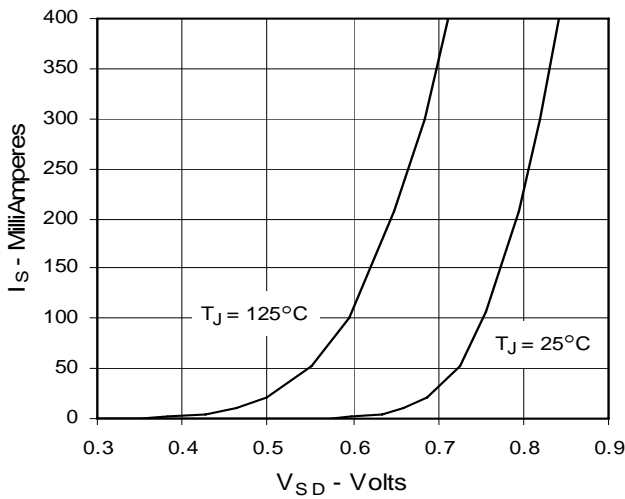

**Fig. 10. Gate Charge**

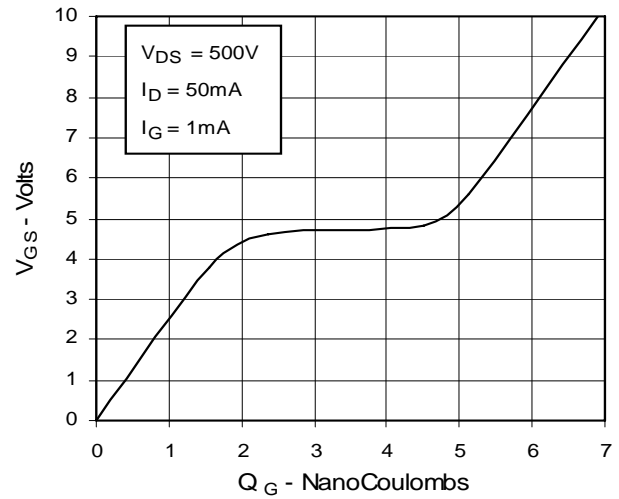

**Fig. 11. Capacitance**

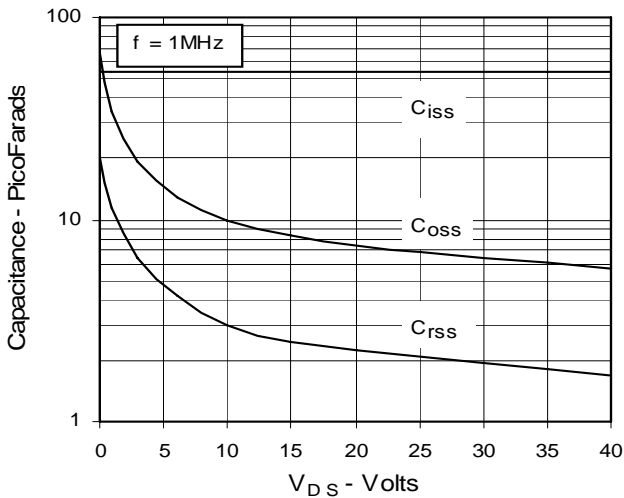

**Fig. 12. Maximum Transient Thermal Resistance**

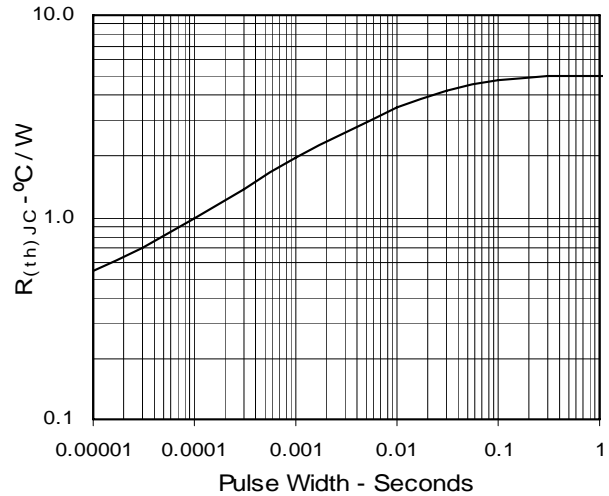

IXYS reserves the right to change limits, test conditions, and dimensions.

IXYS MOSFETs and IGBTs are covered by one or more of the following U.S. patents:

4,835,592	4,881,106	5,017,508	5,049,961	5,187,117	5,486,715	6,306,728B1
4,850,072	4,931,844	5,034,796	5,063,307	5,237,481	5,381,025	

# Mouser Electronics

Authorized Distributor

Click to View Pricing, Inventory, Delivery & Lifecycle Information:

[IXYS:](#)

[IXTU01N100](#)