

PolarHV™ HiPerFET Power MOSFET

IXFK 80N50P
IXFX 80N50P

V_{DSS} = 500 V
I_{D25} = 80 A
R_{DS(on)} ≤ 65 mΩ
t_{rr} ≤ 200 ns

N-Channel Enhancement Mode
Avalanche Rated
Fast Intrinsic Diode



Symbol	Test Conditions	Maximum Ratings	
V _{DSS}	T _J = 25° C to 150° C	500	V
V _{DGR}	T _J = 25° C to 150° C; R _{GS} = 1 MΩ	500	V
V _{GSM}	Transient	± 40	V
V _{GSM}	Continuous	± 30	V
I _{D25}	T _C = 25° C	80	A
I _L	Lead Current Limit, RMS	75	A
I _{DM}	T _C = 25° C, pulse width limited by T _{JM}	200	A
I _{AR}	T _C = 25° C	80	A
E _{AR}	T _C = 25° C	80	mJ
E _{AS}	T _C = 25° C	3.5	J
dv/dt	I _S ≤ I _{DM} , di/dt ≤ 100 A/μs, V _{DD} ≤ V _{DSS} , T _J ≤ 150° C, R _G = 2 Ω	20	V/ns
P _D	T _C = 25° C	1040	W
T _J		-55 ... +150	°C
T _{JM}		150	°C
T _{stg}		-55 ... +150	°C
T _L	1.6 mm (0.062 in.) from case for 10 s	300	°C
T _{SOLD}	Plastic body for 10 seconds	260	°C
F _C	Mounting force (PLUS247)	20..120/4.5..25	N/lb
M _d	Mounting torque (TO-264)	1.13/10	Nm/lb.in.
Weight	TO-264	10	g
	PLUS247	6	g

TO-264 (IXFK)

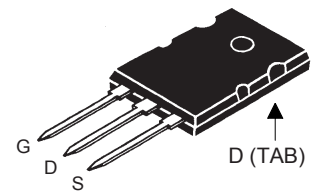

PLUS247 (IXFX)

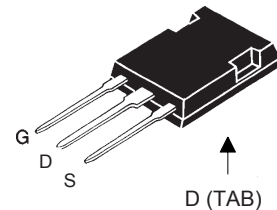

G = Gate S = Source
D = Drain Tab = Collector

Features

- † International standard package
- † Unclamped Inductive Switching (UIS) rated
- † Low package inductance
- easy to drive and to protect

Advantages

- † Easy to mount
- † Space savings
- † High power density

Symbol	Test Conditions (T _J = 25° C unless otherwise specified)	Characteristic Values		
		Min.	Typ.	Max.
BV _{DSS}	V _{GS} = 0 V, I _D = 500 μA	500		V
V _{GS(th)}	V _{DS} = V _{GS} , I _D = 8 mA	3.0		5.0 V
I _{GSS}	V _{GS} = ± 30 V _{DC} , V _{DS} = 0			± 200 nA
I _{DSS}	V _{DS} = V _{DSS} V _{GS} = 0 V T _J = 125° C			25 μA 2 mA
R _{DS(on)}	V _{GS} = 10 V, I _D = 0.5 I _{D25}			65 mΩ

Symbol	Test Conditions	Characteristic Values		
		$(T_J = 25^\circ\text{C}$ unless otherwise specified)		
		Min.	Typ.	Max.
g_{fs}	$V_{DS} = 20\text{ V}; I_D = 0.5 I_{D25}$, Note 1	45	70	S
C_{iss}	$V_{GS} = 0\text{ V}, V_{DS} = 25\text{ V}, f = 1\text{ MHz}$		12.7	nF
C_{oss}			1280	pF
C_{rss}			120	pF
$t_{d(on)}$	$V_{GS} = 10\text{ V}, V_{DS} = 0.5 V_{DSS}, I_D = 0.5 I_{D25}$ $R_G = 1\ \Omega$ (External)		25	ns
t_r			27	ns
$t_{d(off)}$			70	ns
t_f			16	ns
$Q_{g(on)}$	$V_{GS} = 10\text{ V}, V_{DS} = 0.5 V_{DSS}, I_D = 0.5 I_{D25}$		197	nC
Q_{gs}			70	nC
Q_{gd}			64	nC
R_{thJC}				0.12°C/W
R_{thCS}		0.15		$^\circ\text{C/W}$

Symbol	Test Conditions	Characteristic Values		
		$(T_J = 25^\circ\text{C}$ unless otherwise specified)		
		Min.	Typ.	Max.
I_S	$V_{GS} = 0\text{ V}$			80 A
I_{SM}	Repetitive			200 A
V_{SD}	$I_F = I_S, V_{GS} = 0\text{ V}$			1.5 V
t_{rr}	$I_F = 25\text{ A}, -di/dt = 100\text{ A}/\mu\text{s}$ $V_R = 100\text{ V}, V_{GS} = 0\text{ V}$			200 ns
Q_{RM}			0.6	
I_{RM}			6	A

Notes:

1. Pulse test, $t \leq 300\ \mu\text{s}$, duty cycle $d \leq 2\%$

PLUS 247™ (IXFX) Outline

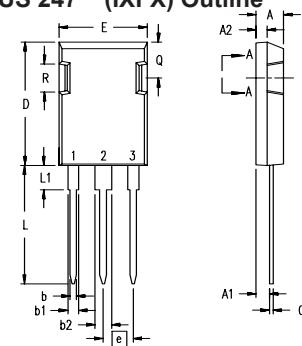

- Terminals: 1 - Gate
2 - Drain (Collector)
3 - Source (Emitter)
4 - Drain (Collector)

Dim.	Millimeter		Inches	
	Min.	Max.	Min.	Max.
A	4.83	5.21	.190	.205
A ₁	2.29	2.54	.090	.100
A ₂	1.91	2.16	.075	.085
b	1.14	1.40	.045	.055
b ₁	1.91	2.13	.075	.084
b ₂	2.92	3.12	.115	.123
C	0.61	0.80	.024	.031
D	20.80	21.34	.819	.840
E	15.75	16.13	.620	.635
e	5.45 BSC		.215 BSC	
L	19.81	20.32	.780	.800
L1	3.81	4.32	.150	.170
Q	5.59	6.20	.220	0.244
R	4.32	4.83	.170	.190

TO-264 (IXFK) Outline

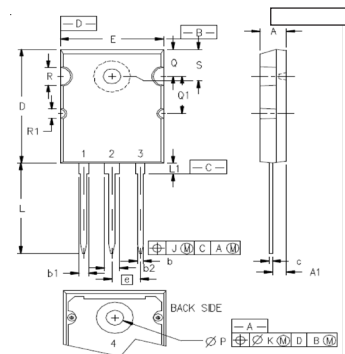

- 1 - GATE
2, 4 - DRAIN (COLLECTOR)
3 - SOURCE (EMITTER)

SYM	INCHES		MILLIMETERS	
	MIN	MAX	MIN	MAX
A	.185	.209	4.70	5.31
A1	.102	.118	2.59	3.00
b	.037	.055	0.94	1.40
b1	.087	.102	2.21	2.59
b2	.110	.126	2.79	3.20
c	.017	.029	0.43	0.74
D	1.007	1.047	25.58	26.59
E	.760	.799	19.30	20.29
e	.215BSC		5.46 BSC	
J	.000	.010	0.00	0.25
K	.000	.010	0.00	0.25
L	.779	.842	19.79	21.39
L1	.087	.102	2.21	2.59
ØP	.122	.138	3.10	3.51
Q	.240	.256	6.10	6.50
Q1	.330	.346	8.38	8.79
ØR	.155	.187	3.94	4.75
ØR1	.085	.093	2.16	2.36
S	.243	.253	6.17	6.43

IXYS reserves the right to change limits, test conditions, and dimensions.

IXYS MOSFETs and IGBTs are covered by 4,835,592 4,931,844 5,049,961 5,237,481 6,162,665 6,404,065 B1 6,683,344 6,727,585
one or more of the following U.S. patents: 4,850,072 5,017,508 5,063,307 5,381,025 6,259,123 B1 6,534,343 6,710,405B2 6,759,692
4,881,106 5,034,796 5,187,117 5,486,715 6,306,728 B1 6,583,505 6,710,463 6,771,478 B2

Fig. 1. Output Characteristics
@ 25°C

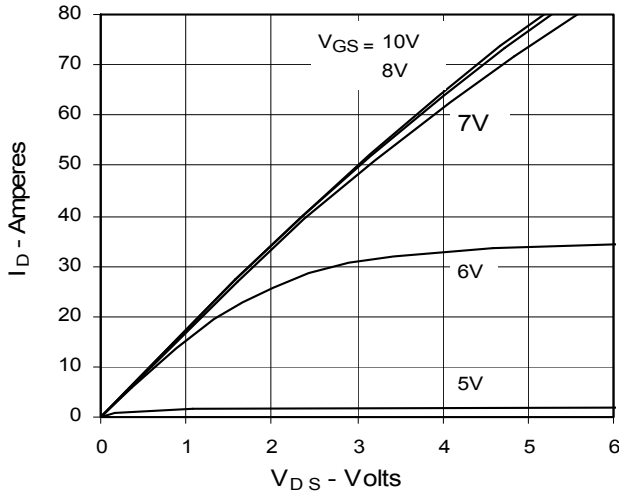

Fig. 2. Extended Output Characteristics
@ 25°C

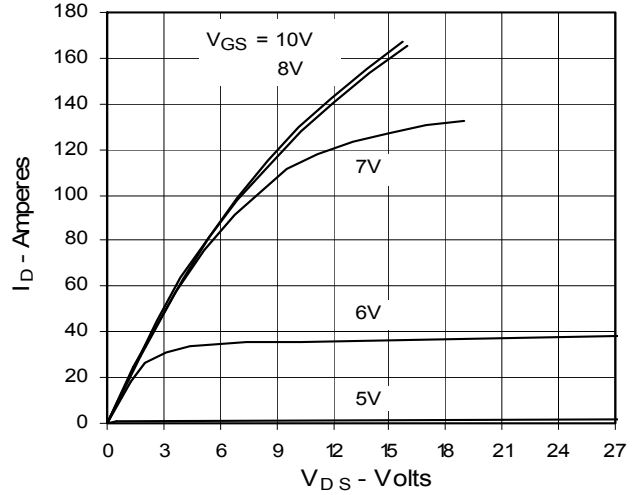

Fig. 3. Output Characteristics
@ 125°C

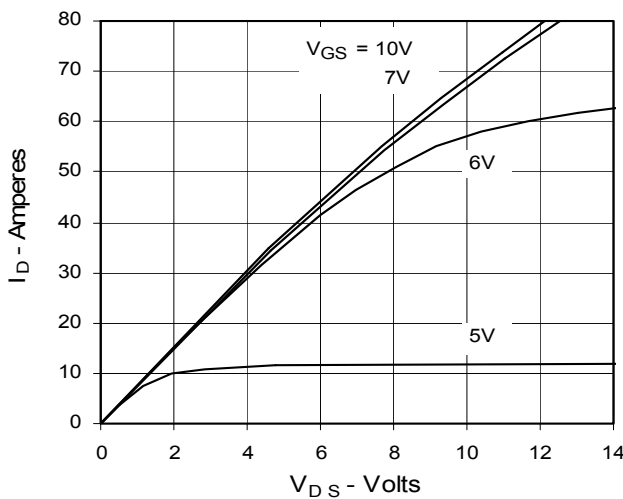

Fig. 4. $R_{DS(on)}$ Normalized to 0.5 I_{D25} Value vs. Junction Temperature

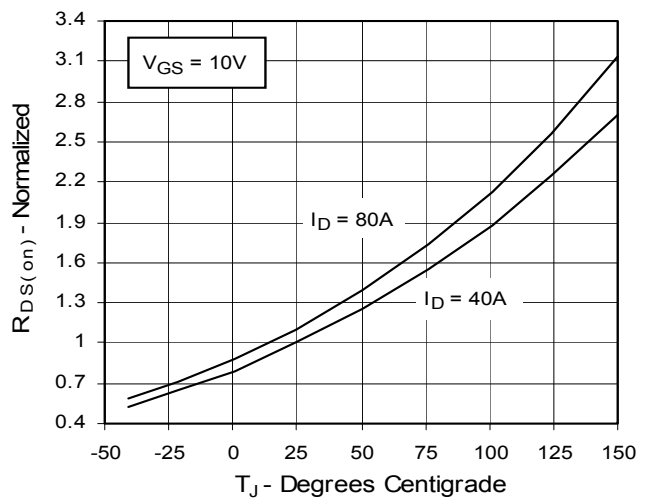

Fig. 5. $R_{DS(on)}$ Normalized to 0.5 I_{D25} Value vs. I_D

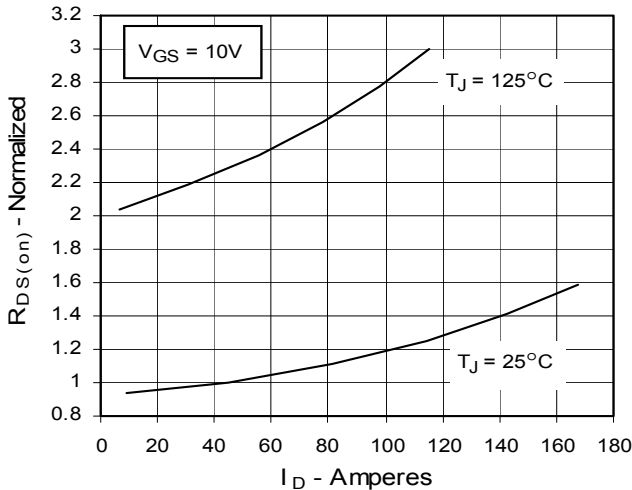

Fig. 6. Drain Current vs. Case Temperature

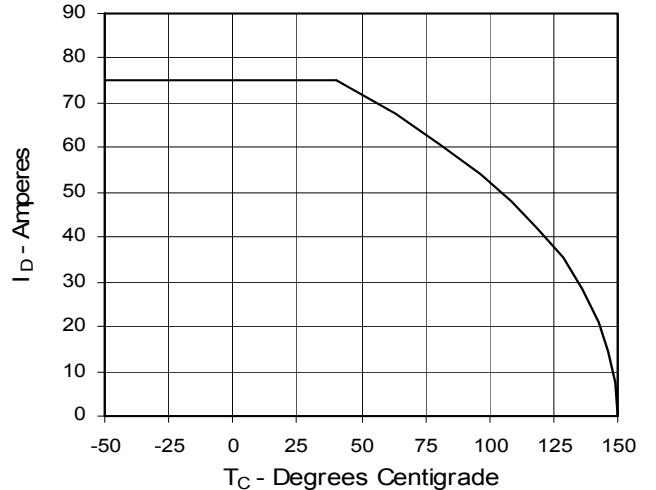

Fig. 7. Input Admittance

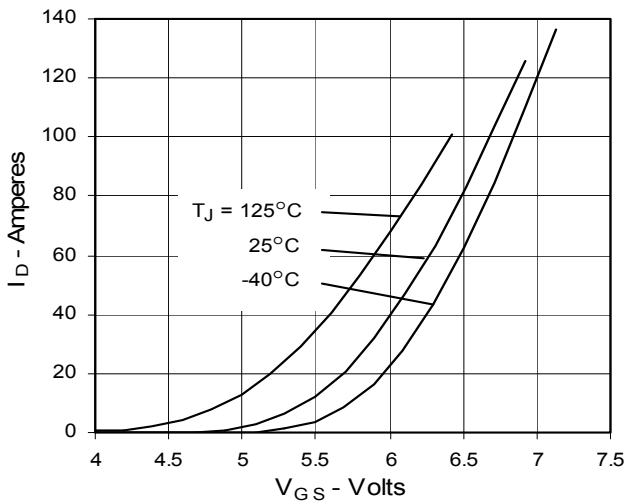

Fig. 8. Transconductance

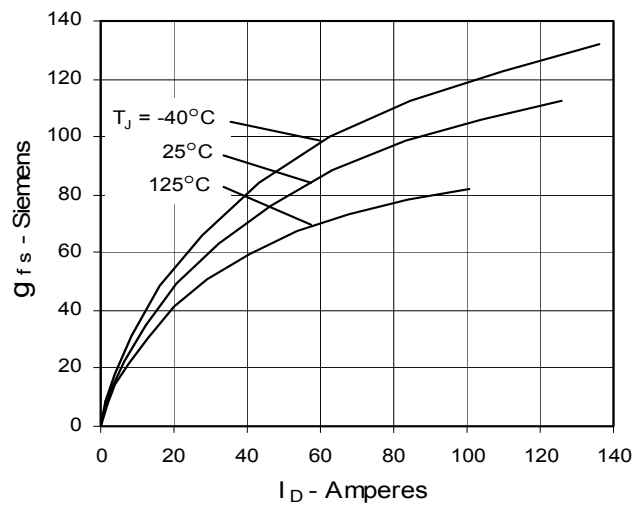

Fig. 9. Source Current vs. Source-To-Drain Voltage

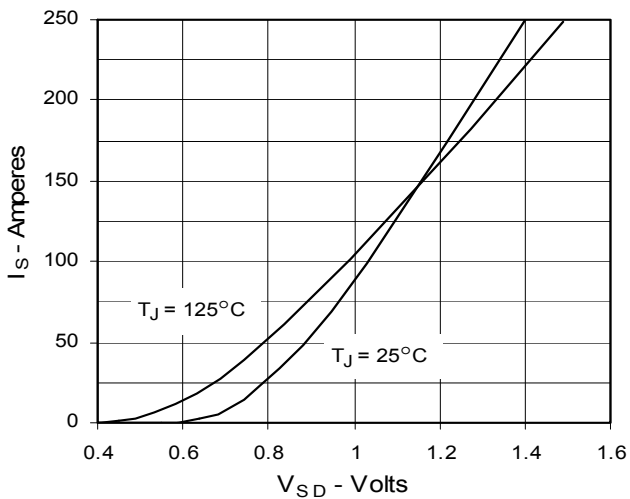

Fig. 10. Gate Charge

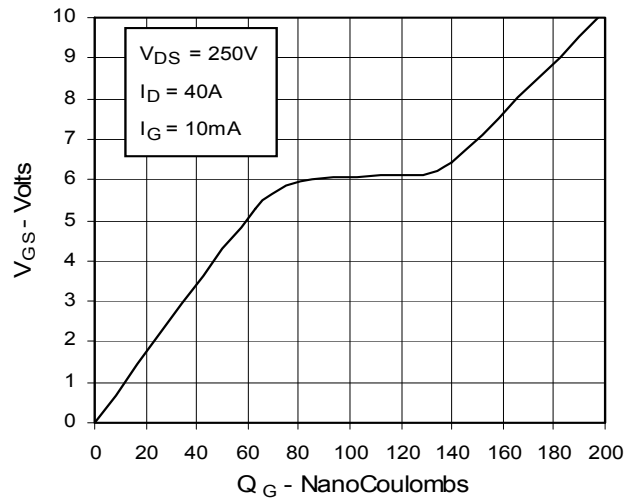

Fig. 11. Capacitance

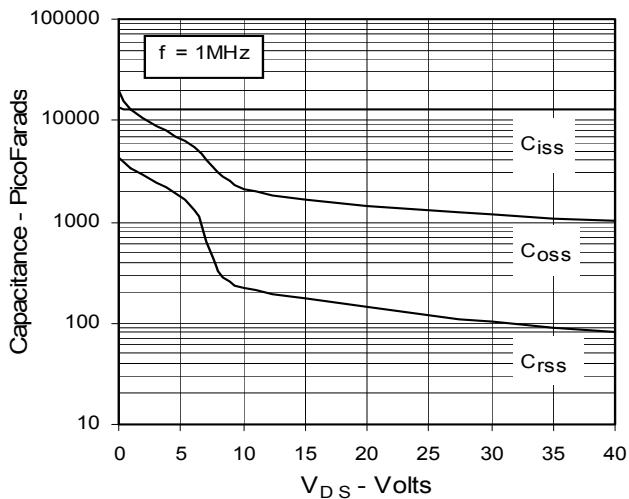

Fig. 12. Forward-Bias Safe Operating Area

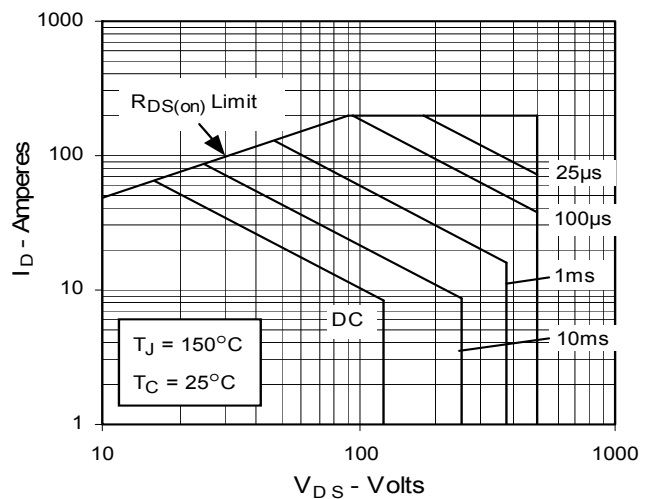
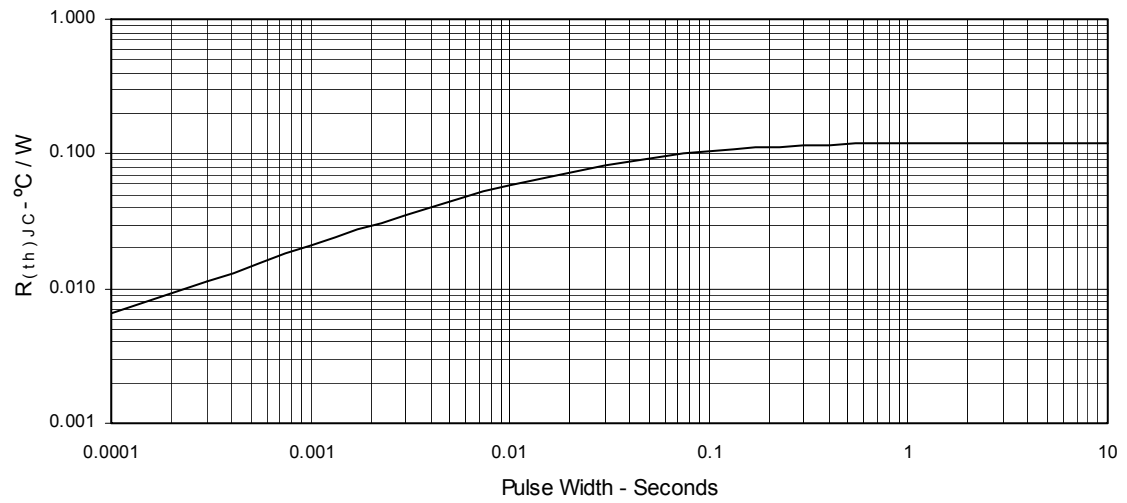

Fig. 13. Maximum Transient Thermal Resistance



Mouser Electronics

Authorized Distributor

Click to View Pricing, Inventory, Delivery & Lifecycle Information:

[IXYS:](#)

[IXFK80N50P](#) [IXFX80N50P](#)