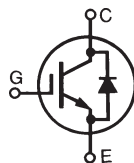


# 1200V XPT™ IGBT GenX3™ w/ Diode

## IXYH30N120C3D1

High-Speed IGBT  
for 20-50 kHz Switching



$V_{CES} = 1200V$   
 $I_{C110} = 30A$   
 $V_{CE(sat)} \leq 3.3V$   
 $t_{fi(typ)} = 88ns$

Symbol	Test Conditions	Maximum Ratings	
$V_{CES}$	$T_J = 25^\circ C$ to $150^\circ C$	1200	V
$V_{CGR}$	$T_J = 25^\circ C$ to $150^\circ C$ , $R_{GE} = 1M\Omega$	1200	V
$V_{GES}$	Continuous	$\pm 20$	V
$V_{GEM}$	Transient	$\pm 30$	V
$I_{C25}$	$T_C = 25^\circ C$	66	A
$I_{C110}$	$T_C = 110^\circ C$	30	A
$I_{F110}$	$T_C = 110^\circ C$	20	A
$I_{CM}$	$T_C = 25^\circ C$ , 1ms	133	A
$I_A$	$T_C = 25^\circ C$	20	A
$E_{AS}$	$T_C = 25^\circ C$	400	mJ
<b>SSOA</b> <b>(RBSOA)</b>	$V_{GE} = 15V$ , $T_{VJ} = 150^\circ C$ , $R_G = 10\Omega$ Clamped Inductive Load	$I_{CM} = 60$ @ $V_{CE} \leq V_{CES}$	A
$P_C$	$T_C = 25^\circ C$	416	W
$T_J$		-55 ... +150	$^\circ C$
$T_{JM}$		150	$^\circ C$
$T_{stg}$		-55 ... +150	$^\circ C$
$T_L$	Maximum Lead Temperature for Soldering	300	$^\circ C$
$T_{SOLD}$	1.6 mm (0.062in.) from Case for 10s	260	$^\circ C$
$M_d$	Mounting Torque	1.13/10	Nm/lb.in
<b>Weight</b>		6	g

### TO-247 AD



G = Gate      C = Collector  
E = Emitter    Tab = Collector

### Features

- Optimized for Low Switching Losses
- Square RBSOA
- Positive Thermal Coefficient of  $V_{ce(sat)}$
- Anti-Parallel Ultra Fast Diode
- Avalanche Rated
- High Current Handling Capability
- International Standard Package

### Advantages

- High Power Density
- Low Gate Drive Requirement

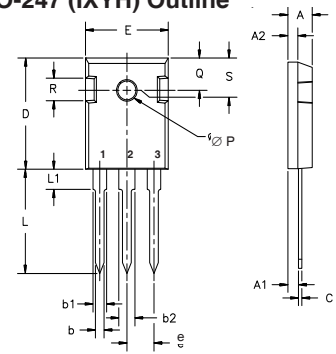
### Applications

- High Frequency Power Inverters
- UPS
- Motor Drives
- SMPS
- PFC Circuits
- Battery Chargers
- Welding Machines
- Lamp Ballasts

Symbol	Test Conditions ( $T_J = 25^\circ C$ , Unless Otherwise Specified)	Characteristic Values		
		Min.	Typ.	Max.
$BV_{CES}$	$I_C = 250\mu A$ , $V_{GE} = 0V$	1200		V
$V_{GE(th)}$	$I_C = 250\mu A$ , $V_{CE} = V_{GE}$	3.0		5.0 V
$I_{CES}$	$V_{CE} = V_{CES}$ , $V_{GE} = 0V$ $T_J = 125^\circ C$			25 $\mu A$ 350 $\mu A$
$I_{GES}$	$V_{CE} = 0V$ , $V_{GE} = \pm 20V$			$\pm 100$ nA
$V_{CE(sat)}$	$I_C = 30A$ , $V_{GE} = 15V$ , Note 1 $T_J = 150^\circ C$		3.7	3.3 V V

Symbol Test Conditions ( $T_J = 25^\circ\text{C}$ Unless Otherwise Specified)		Characteristic Values		
		Min.	Typ.	Max.
$g_{fs}$	$I_C = 30\text{A}, V_{CE} = 10\text{V}$ , Note 1	10	17	S
$C_{ies}$	$V_{CE} = 25\text{V}, V_{GE} = 0\text{V}, f = 1\text{MHz}$		1640	pF
$C_{oes}$			140	pF
$C_{res}$			38	pF
$Q_{g(on)}$	$I_C = 30\text{A}, V_{GE} = 15\text{V}, V_{CE} = 0.5 \cdot V_{CES}$		69	nC
$Q_{ge}$			9	nC
$Q_{gc}$			34	nC
$t_{d(on)}$	<b>Inductive load, <math>T_J = 25^\circ\text{C}</math></b> $I_C = 30\text{A}, V_{GE} = 15\text{V}$ $V_{CE} = 0.5 \cdot V_{CES}, R_G = 10\Omega$ Note 2		19	ns
$t_{ri}$			40	ns
$E_{on}$			2.6	mJ
$t_{d(off)}$			130	ns
$t_{fi}$			88	ns
$E_{off}$			1.1	mJ
$t_{d(on)}$	<b>Inductive load, <math>T_J = 150^\circ\text{C}</math></b> $I_C = 30\text{A}, V_{GE} = 15\text{V}$ $V_{CE} = 0.5 \cdot V_{CES}, R_G = 10\Omega$ Note 2		19	ns
$t_{ri}$			52	ns
$E_{on}$			6.0	mJ
$t_{d(off)}$			156	ns
$t_{fi}$			140	ns
$E_{off}$			1.6	mJ
$R_{thJC}$			0.30	$^\circ\text{C/W}$
$R_{thCS}$		0.21		$^\circ\text{C/W}$

TO-247 (IXYH) Outline



Terminals: 1 - Gate 2 - Collector  
3 - Emitter

Dim.	Millimeter		Inches	
	Min.	Max.	Min.	Max.
A	4.7	5.3	.185	.209
A <sub>1</sub>	2.2	2.54	.087	.102
A <sub>2</sub>	2.2	2.6	.059	.098
b	1.0	1.4	.040	.055
b <sub>1</sub>	1.65	2.13	.065	.084
b <sub>2</sub>	2.87	3.12	.113	.123
C	.4	.8	.016	.031
D	20.80	21.46	.819	.845
E	15.75	16.26	.610	.640
e	5.20	5.72	0.205	0.225
L	19.81	20.32	.780	.800
L1		4.50		.177
∅P	3.55	3.65	.140	.144
Q	5.89	6.40	0.232	0.252
R	4.32	5.49	.170	.216
S	6.15	BSC	.242	BSC

### Reverse Diode (FRED)

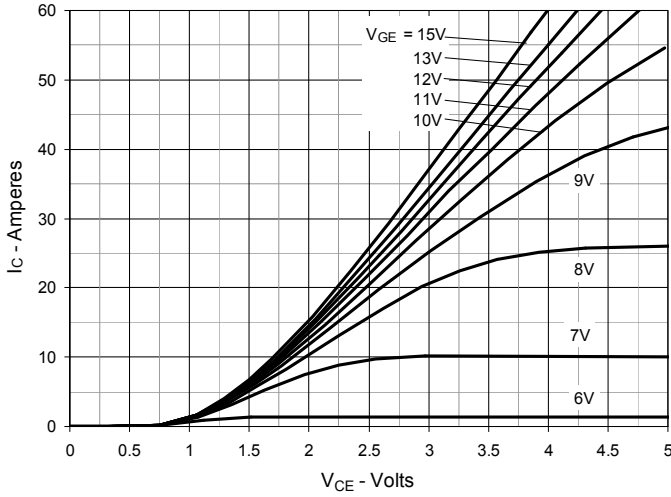
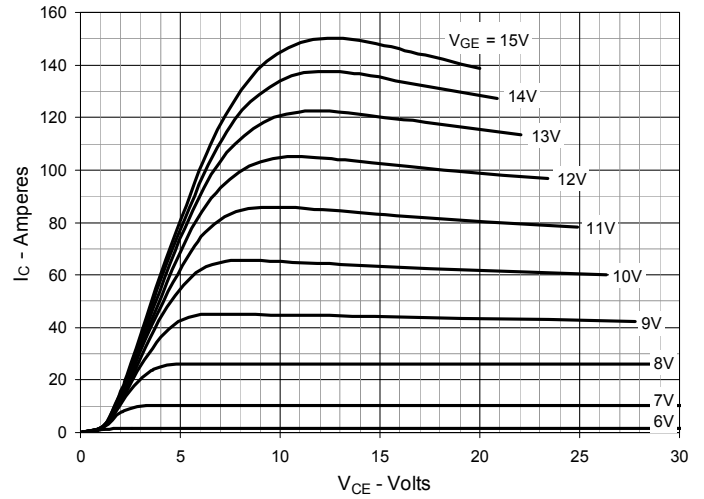
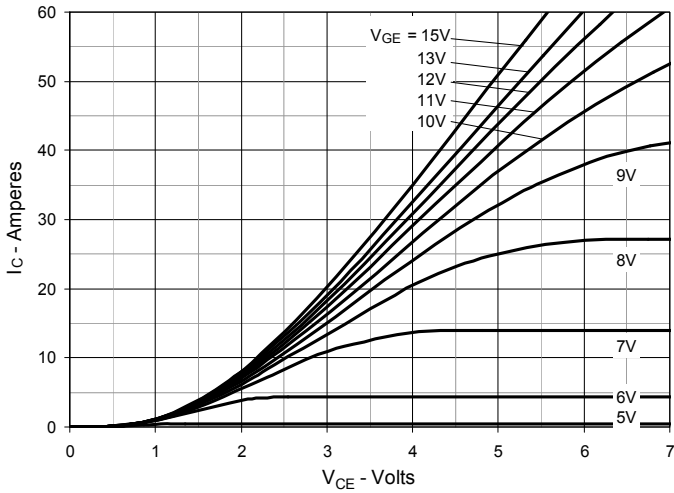
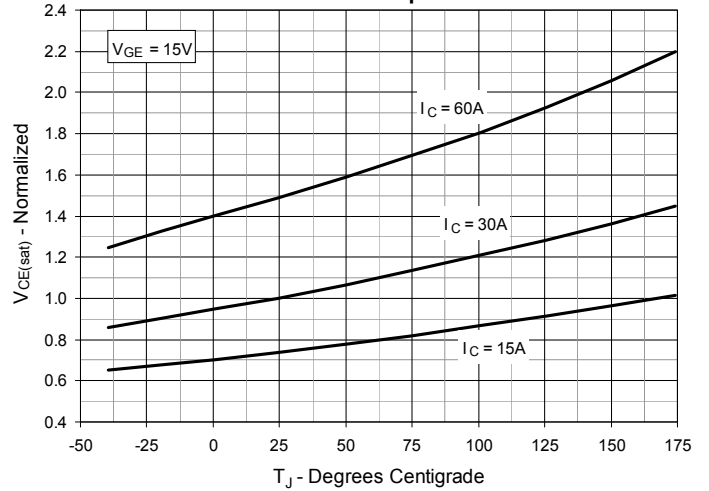
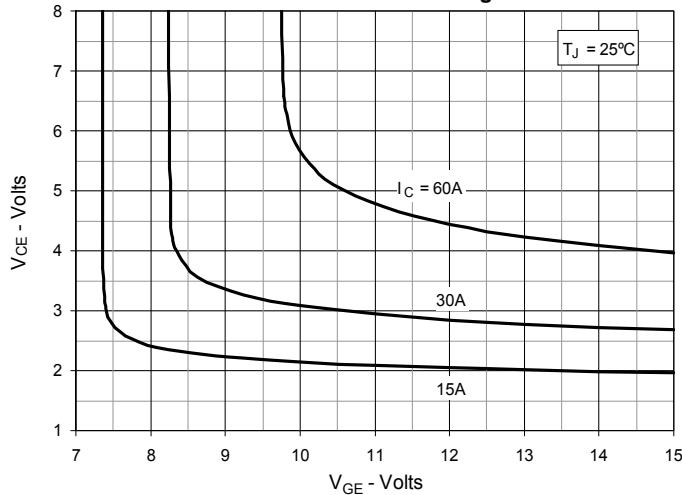
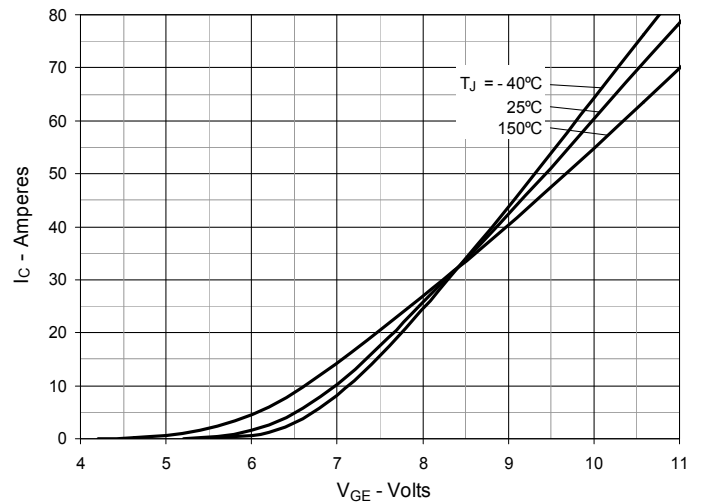
(T <sub>J</sub> = 25°C, Unless Otherwise Specified)		Characteristic Value		
Symbol	Test Conditions	Min.	Typ.	Max.
V <sub>F</sub>	$I_F = 30\text{A}, V_{GE} = 0\text{V}$ , Note 1		1.75	3.00 V
				$T_J = 150^\circ\text{C}$
I <sub>RM</sub>	$I_F = 30\text{A}, V_{GE} = 0\text{V}, -di_F/dt = 100\text{A}/\mu\text{s}, V_R = 600\text{V}$			9 A
t <sub>rr</sub>			195	ns
R <sub>thJC</sub>				0.90 $^\circ\text{C/W}$

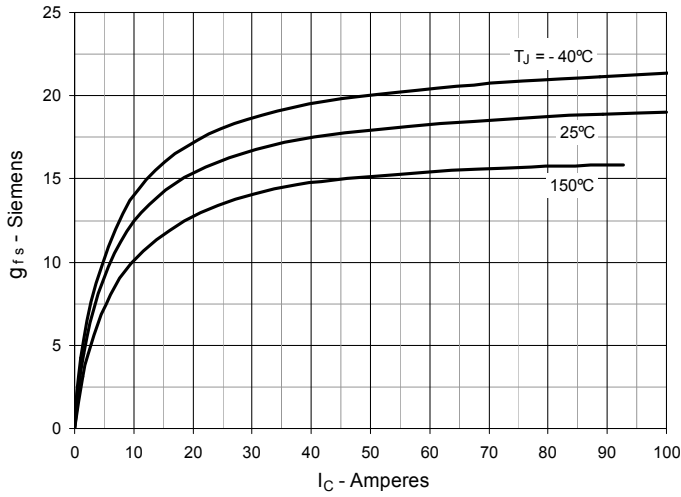
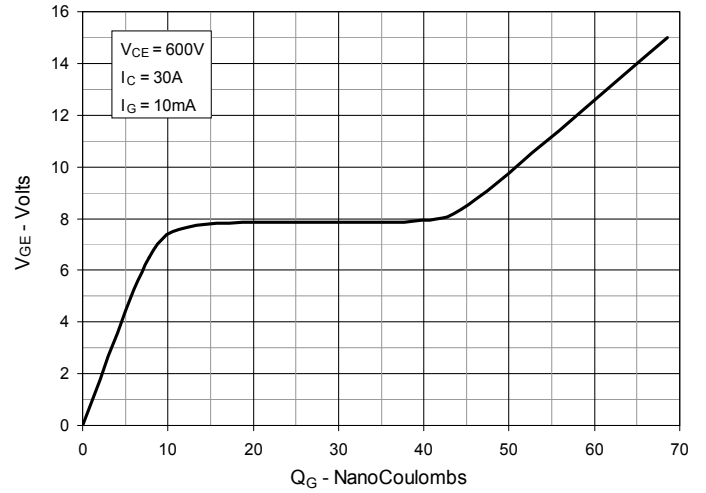
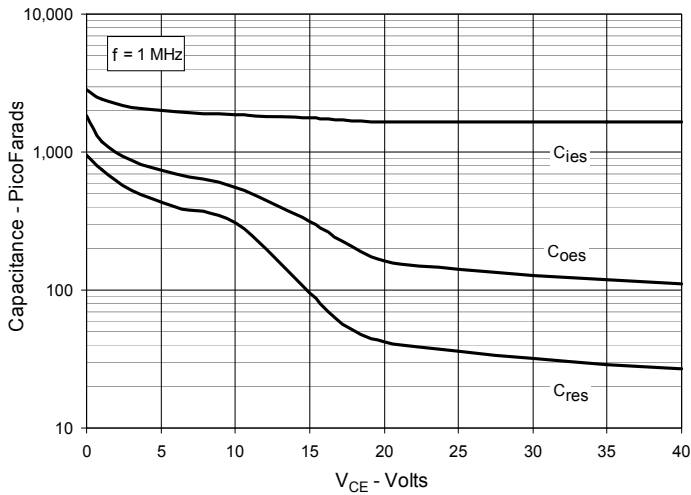
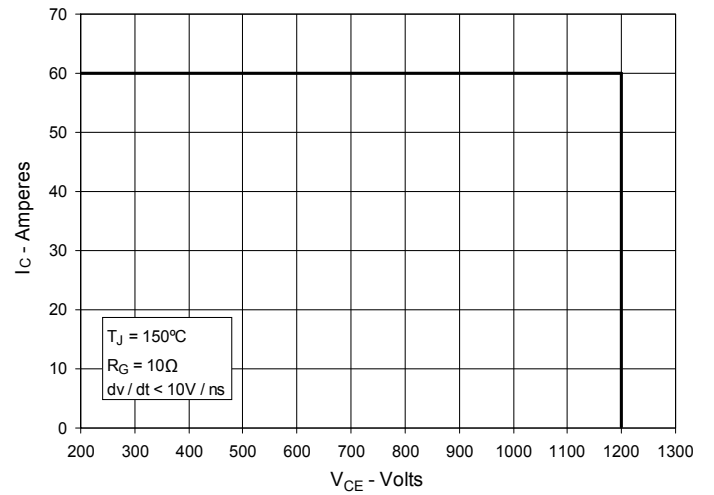
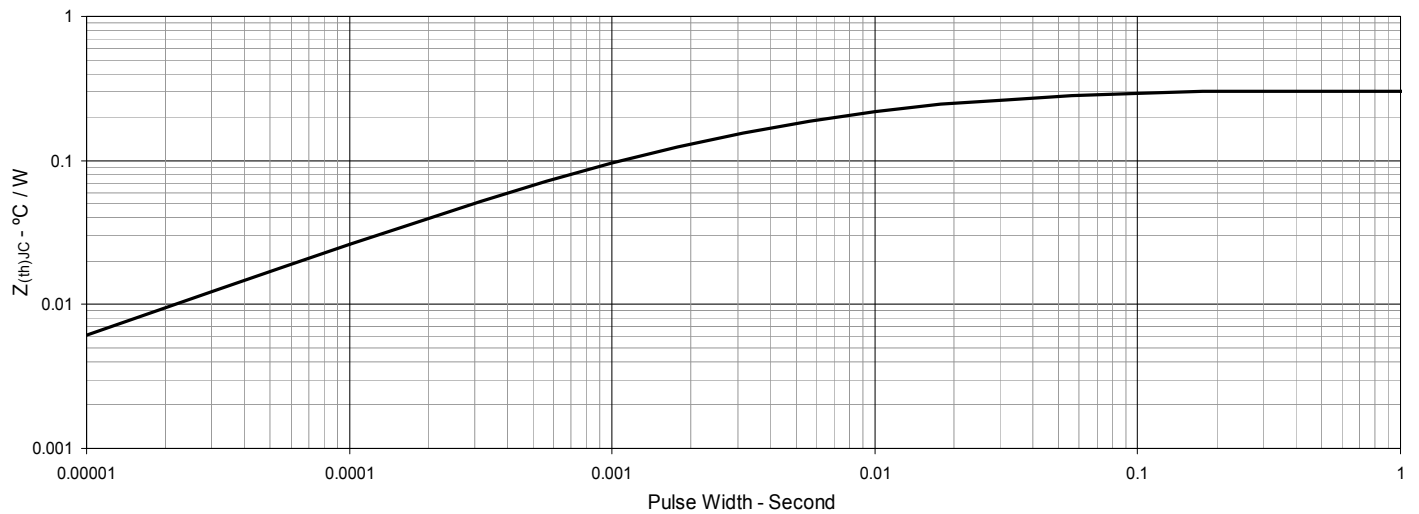
Notes:

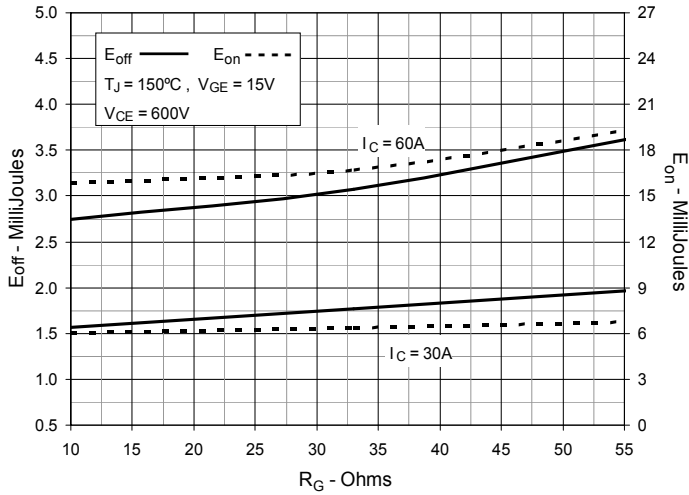
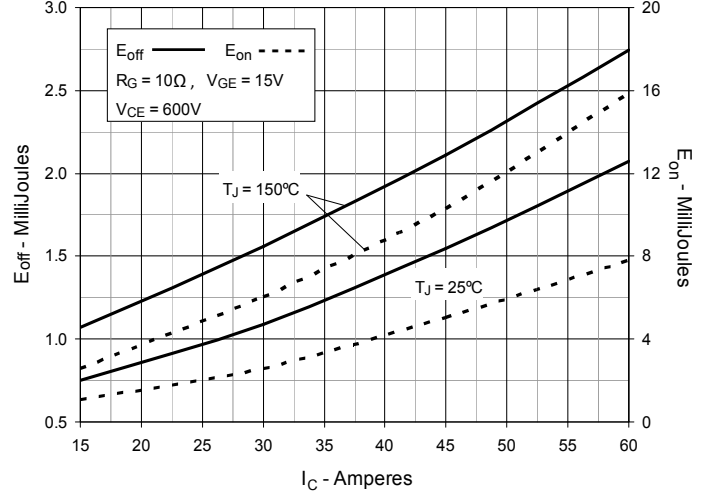
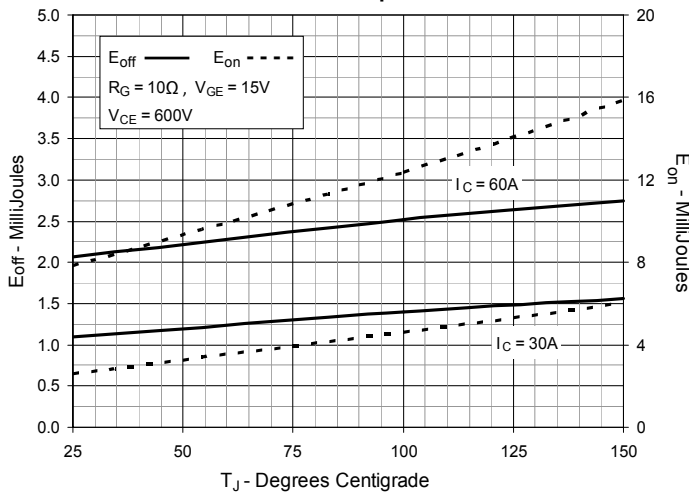
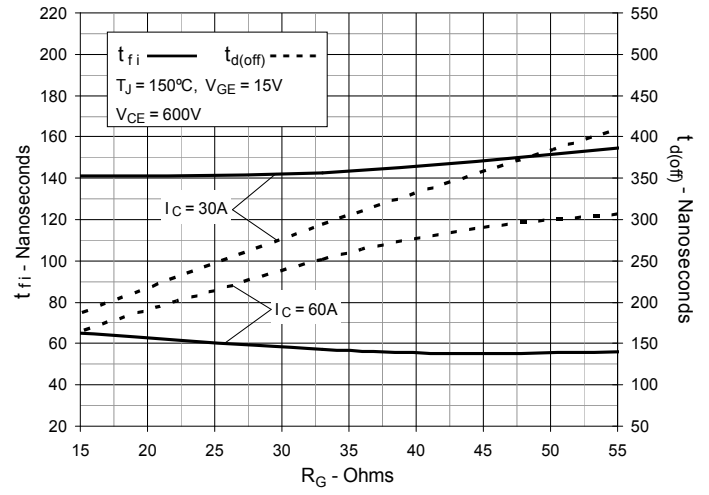
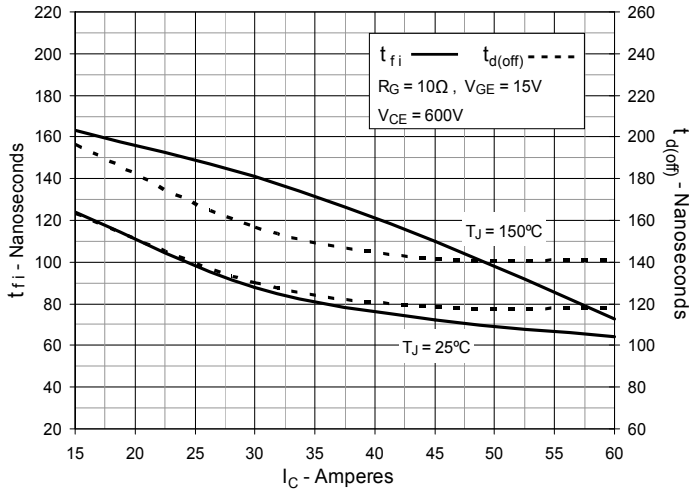
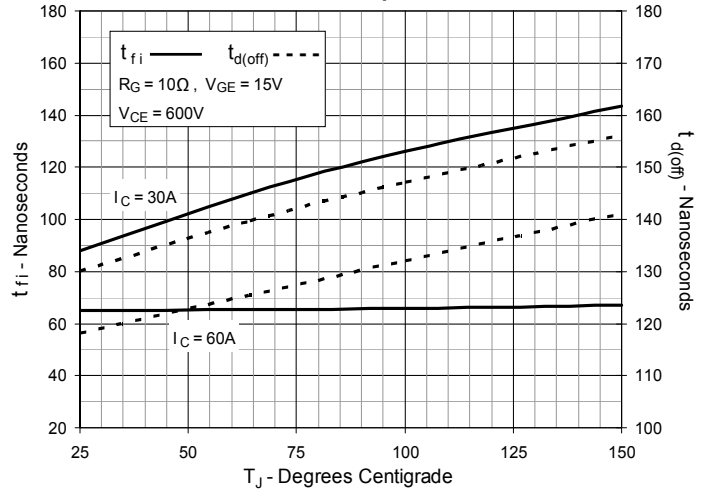
1. Pulse test,  $t \leq 300\mu\text{s}$ , duty cycle,  $d \leq 2\%$ .
2. Switching times & energy losses may increase for higher  $V_{CE}$ (clamp),  $T_J$  or  $R_G$ .

IXYS Reserves the Right to Change Limits, Test Conditions, and Dimensions.

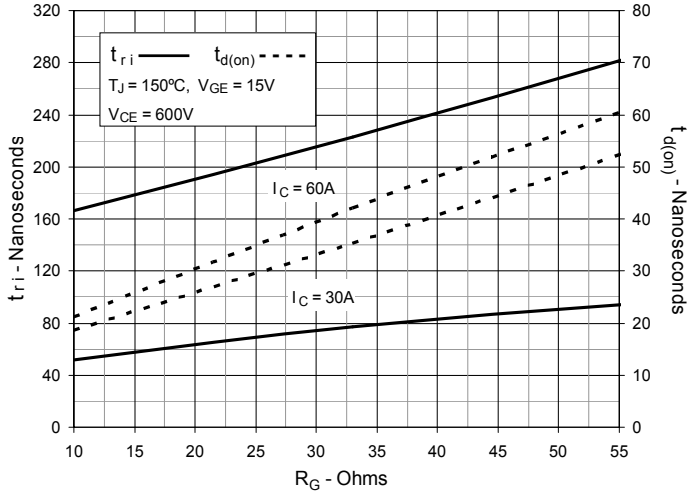
IXYS MOSFETs and IGBTs are covered by one or more of the following U.S. patents:	4,835,592	4,931,844	5,049,961	5,237,481	6,162,665	6,404,065 B1	6,683,344	6,727,585	7,005,734 B2	7,157,338B2
	4,860,072	5,017,508	5,063,307	5,381,025	6,259,123 B1	6,534,343	6,710,405 B2	6,759,692	7,063,975 B2	
	4,881,106	5,034,796	5,187,117	5,486,715	6,306,728 B1	6,583,505	6,710,463	6,771,478 B2	7,071,537	

**Fig. 1. Output Characteristics @  $T_J = 25^\circ\text{C}$** 

**Fig. 2. Extended Output Characteristics @  $T_J = 25^\circ\text{C}$** 

**Fig. 3. Output Characteristics @  $T_J = 150^\circ\text{C}$** 

**Fig. 4. Dependence of  $V_{CE(sat)}$  on Junction Temperature**

**Fig. 5. Collector-to-Emitter Voltage vs. Gate-to-Emitter Voltage**

**Fig. 6. Input Admittance**


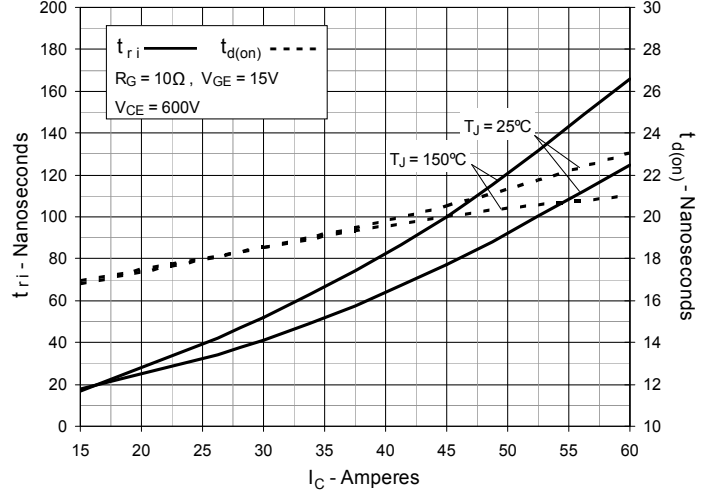
**Fig. 7. Transconductance**

**Fig. 8. Gate Charge**

**Fig. 9. Capacitance**

**Fig. 10. Reverse-Bias Safe Operating Area**

**Fig. 11. Maximum Transient Thermal Impedance (IGBT)**


**Fig. 12. Inductive Switching Energy Loss vs. Gate Resistance**

**Fig. 13. Inductive Switching Energy Loss vs. Collector Current**

**Fig. 14. Inductive Switching Energy Loss vs. Junction Temperature**

**Fig. 15. Inductive Turn-off Switching Times vs. Gate Resistance**

**Fig. 16. Inductive Turn-off Switching Times vs. Collector Current**

**Fig. 17. Inductive Turn-off Switching Times vs. Junction Temperature**


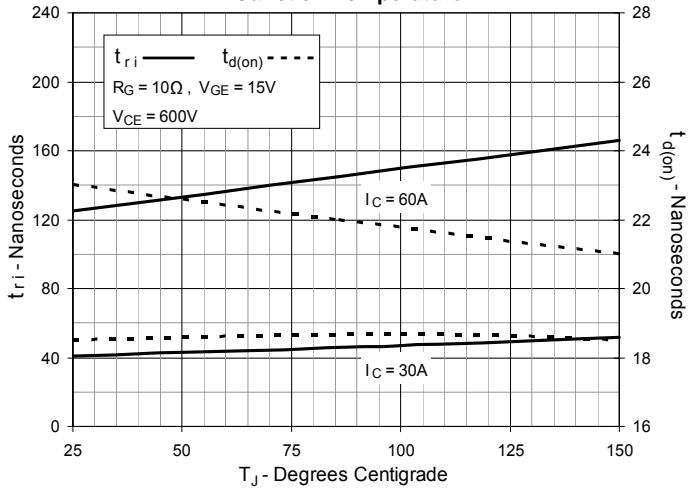
**Fig. 18. Inductive Turn-on Switching Times vs. Gate Resistance**



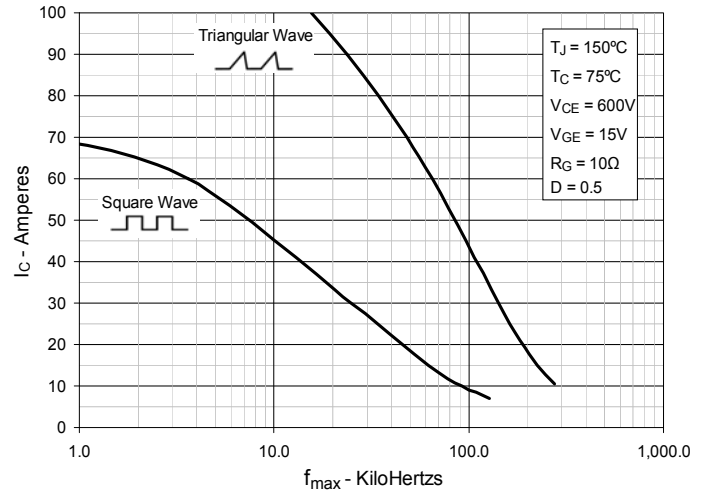
**Fig. 19. Inductive Turn-on Switching Times vs. Collector Current**



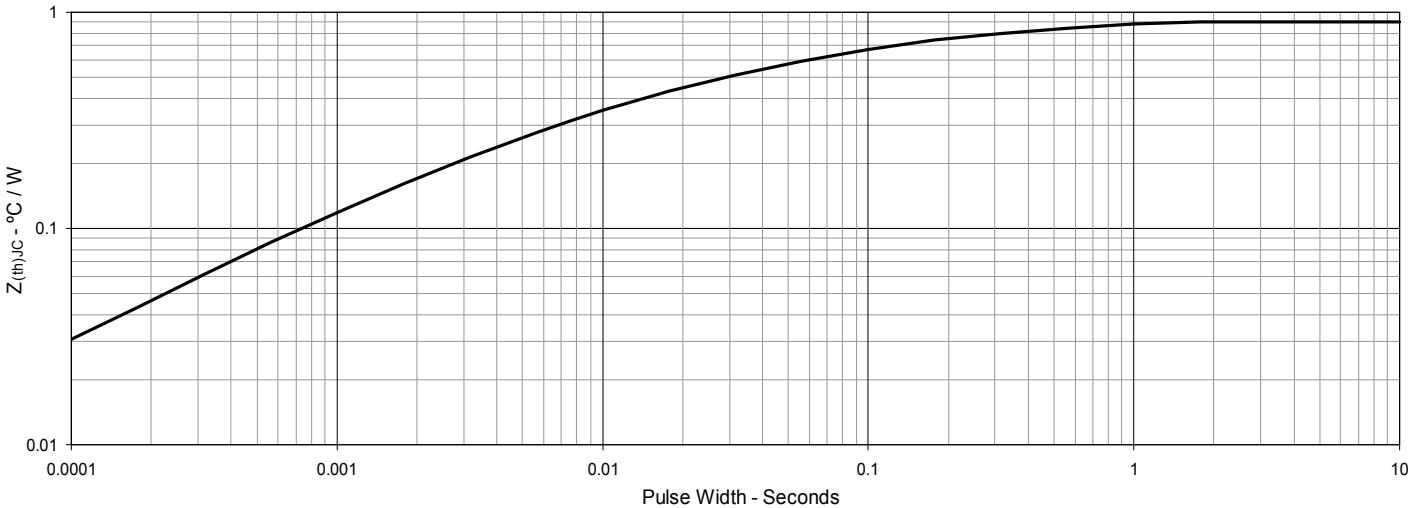
**Fig. 20. Inductive Turn-on Switching Times vs. Junction Temperature**

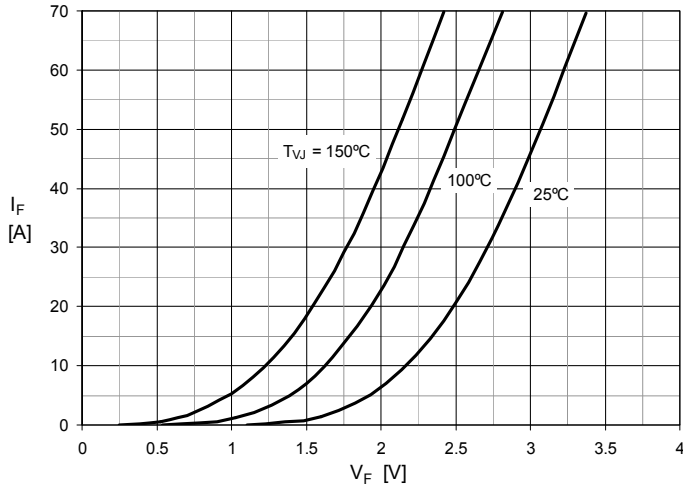
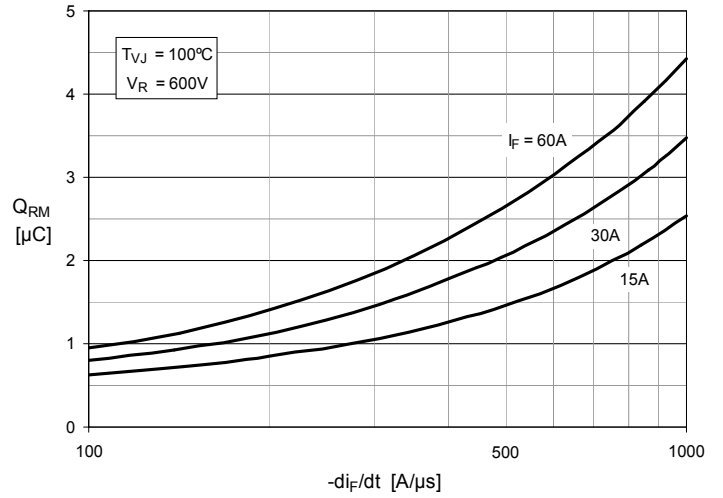
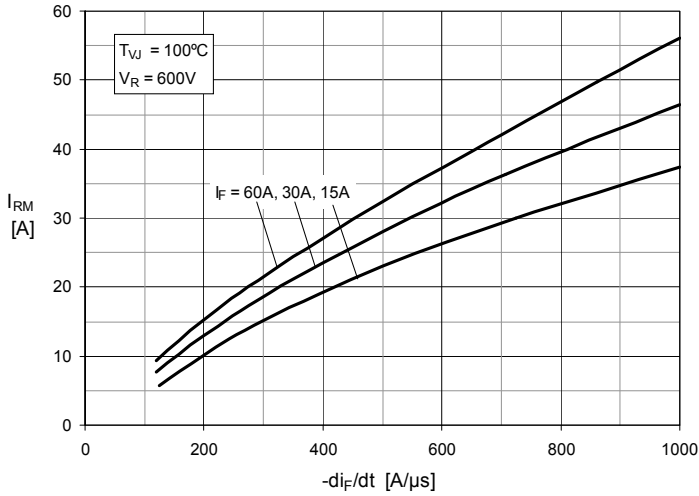
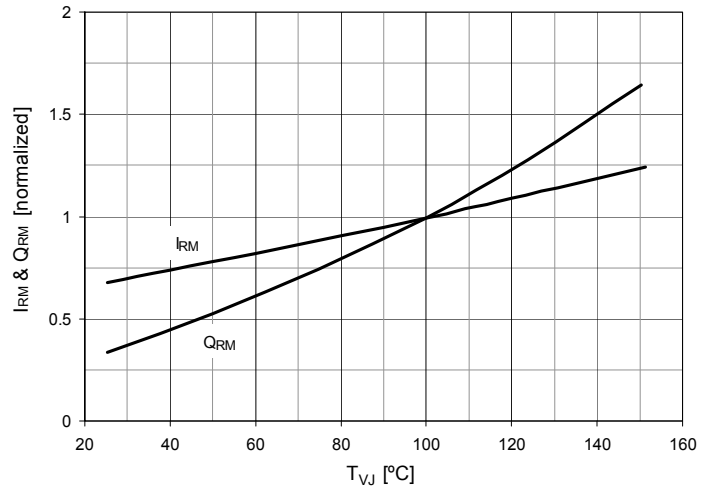
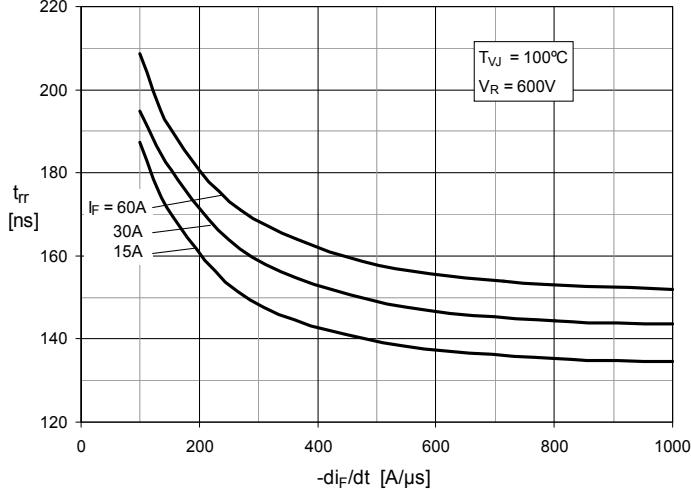
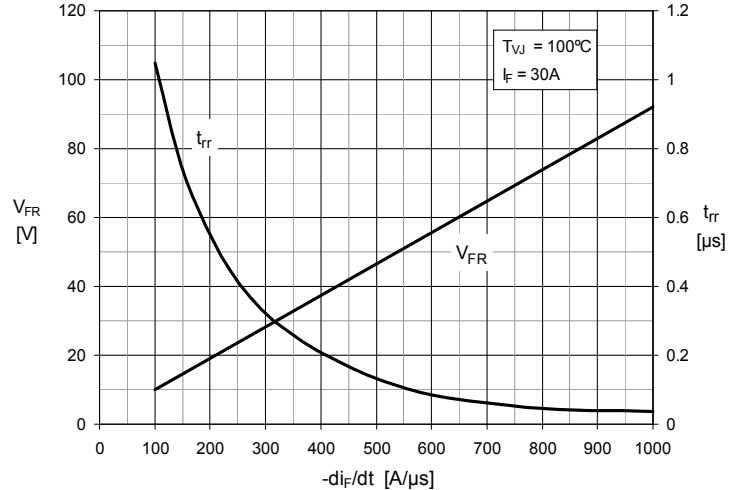


**Fig. 21. Maximum Peak Load Current vs. Frequency**



**Fig. 22. Maximum Transient Thermal Impedance (Diode)**



**Fig. 23. Forward Current  $I_F$  vs  $V_F$** 

**Fig. 24. Reverse Recovery Charge  $Q_{RM}$  vs.  $-di_F/dt$** 

**Fig. 25. Peak Reverse Current  $I_{RM}$  vs.  $-di_F/dt$** 

**Fig. 26. Dynamic Parameters  $Q_{RM}$ ,  $I_{RM}$  vs.  $T_{VJ}$** 

**Fig. 27. Recovery Time  $t_{rr}$  vs.  $-di_F/dt$** 

**Fig. 28. Peak Forward Voltage  $V_{FR}$ ,  $t_{rr}$  vs  $-di_F/dt$** 


# Mouser Electronics

Authorized Distributor

Click to View Pricing, Inventory, Delivery & Lifecycle Information:

[IXYS:](#)

[IXYH30N120C3D1](#)