

# CoolMOS™ 1) Power MOSFET

N-Channel Enhancement Mode  
 Low  $R_{DS(on)}$ , High  $V_{DSS}$  MOSFET  
 Ultra low gate charge

$I_{D25}$  = 70 A  
 $V_{DSS}$  = 600 V  
 $R_{DS(on) \text{ max}}$  = 0.045  $\Omega$

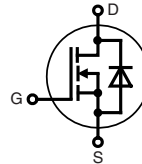

TO-247 AD (IXKH)

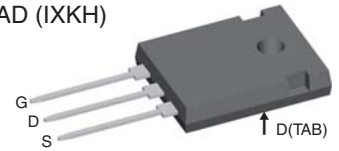

MOSFET			
Symbol	Conditions	Maximum Ratings	
$V_{DSS}$	$T_{VJ} = 25^{\circ}\text{C}$	600	V
$V_{GS}$		$\pm 20$	V
$I_{D25}$	$T_C = 25^{\circ}\text{C}$	70	A
$I_{D90}$	$T_C = 90^{\circ}\text{C}$	48	A
$E_{AS}$ $E_{AR}$	single pulse repetitive } $I_D = 11 \text{ A}; T_C = 25^{\circ}\text{C}$	1950 3	mJ mJ
$dV/dt$	MOSFET $dV/dt$ ruggedness $V_{DS} = 0 \dots 480 \text{ V}$	50	V/ns

## Features

- fast CoolMOS™ 1) power MOSFET 4<sup>th</sup> generation
- High blocking capability
- Lowest resistance
- Avalanche rated for unclamped inductive switching (UIS)
- Low thermal resistance due to reduced chip thickness
- Enhanced total power density

## Applications

- Switched mode power supplies (SMPS)
- Uninterruptible power supplies (UPS)
- Power factor correction (PFC)
- Welding
- Inductive heating
- PDP and LCD adapter

<sup>1)</sup> CoolMOS™ is a trademark of Infineon Technologies AG.

Symbol	Conditions	Characteristic Values			
		$(T_{VJ} = 25^{\circ}\text{C}, \text{ unless otherwise specified})$			
		min.	typ.	max.	
$R_{DS(on)}$	$V_{GS} = 10 \text{ V}; I_D = 44 \text{ A}$		40	45	m $\Omega$
$V_{GS(th)}$	$V_{DS} = V_{GS}; I_D = 3 \text{ mA}$	2.5	3	3.5	V
$I_{DSS}$	$V_{DS} = 600 \text{ V}; V_{GS} = 0 \text{ V}$			10	$\mu\text{A}$
			50		$\mu\text{A}$
$I_{GSS}$	$V_{GS} = \pm 20 \text{ V}; V_{DS} = 0 \text{ V}$			100	nA
$C_{iss}$ $C_{oss}$	} $V_{GS} = 0 \text{ V}; V_{DS} = 100 \text{ V}$ } $f = 1 \text{ MHz}$		6800 320		pF pF
$Q_g$ $Q_{gs}$ $Q_{gd}$	} $V_{GS} = 0 \text{ to } 10 \text{ V}; V_{DS} = 400 \text{ V}; I_D = 44 \text{ A}$		150 35 50	190	nC nC nC
$t_{d(on)}$ $t_r$ $t_{d(off)}$ $t_f$	} $V_{GS} = 10 \text{ V}; V_{DS} = 400 \text{ V}$ } $I_D = 44 \text{ A}; R_G = 3.3 \Omega$		30 20 100 10		ns ns ns ns
$R_{thJC}$				0.2	K/W

**Source-Drain Diode**

Symbol	Conditions	Characteristic Values		
		min.	typ.	max.
( $T_{VJ} = 25^{\circ}\text{C}$ , unless otherwise specified)				
$I_S$	$V_{GS} = 0\text{ V}$		44	A
$V_{SD}$	$I_F = 44\text{ A}; V_{GS} = 0\text{ V}$	0.9	1.2	V
$t_{rr}$ $Q_{RM}$ $I_{RM}$	} $I_F = 44\text{ A}; -di_F/dt = 100\text{ A}/\mu\text{s}; V_R = 400\text{ V}$	600		ns
		17		$\mu\text{C}$
		60		A

**Component**

Symbol	Conditions	Maximum Ratings	
$T_{VJ}$	operating	-55...+150	$^{\circ}\text{C}$
$T_{stg}$		-55...+150	$^{\circ}\text{C}$
$M_d$	mounting torque	0.8 ... 1.2	Nm

Symbol	Conditions	Characteristic Values		
		min.	typ.	max.
$R_{thCH}$	with heatsink compound	0.25		K/W
<b>Weight</b>		6		g

## TO-247 AD Outline

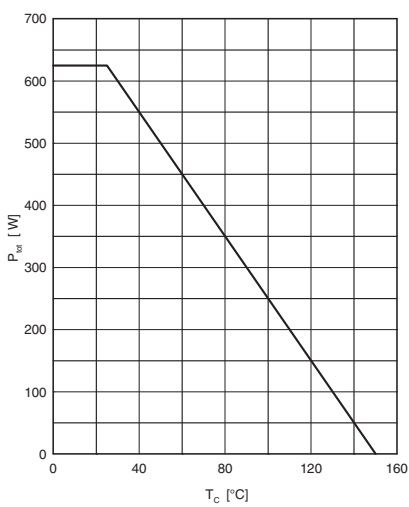
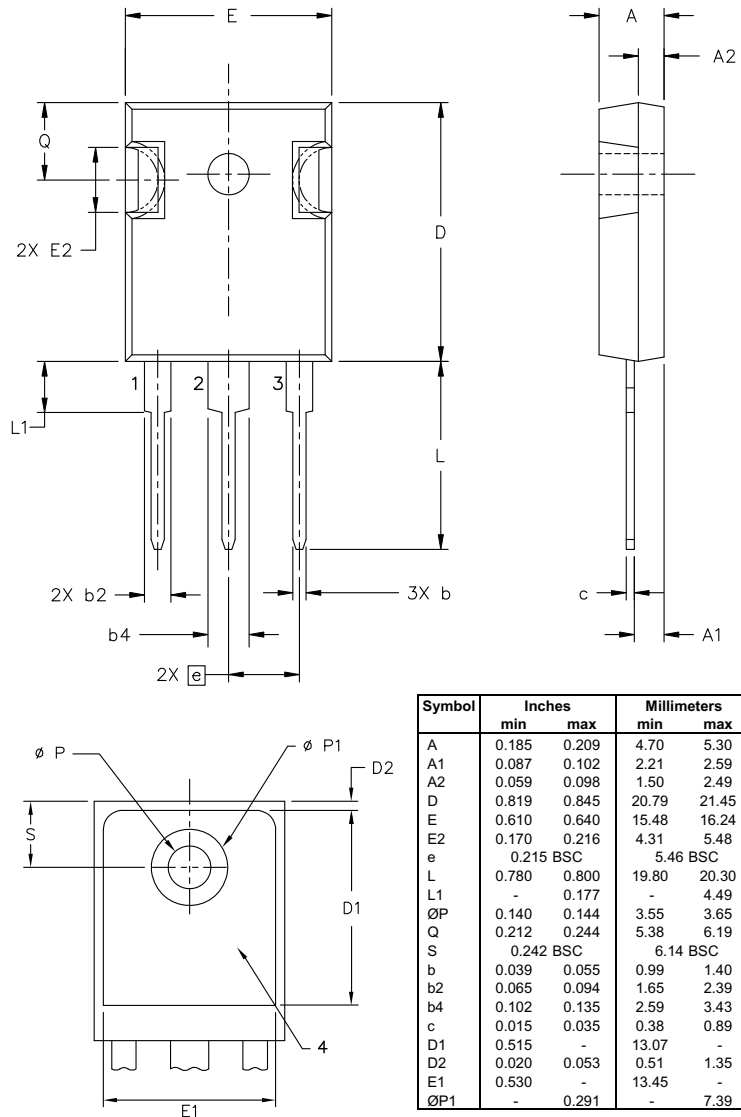

Fig. 1 Power dissipation

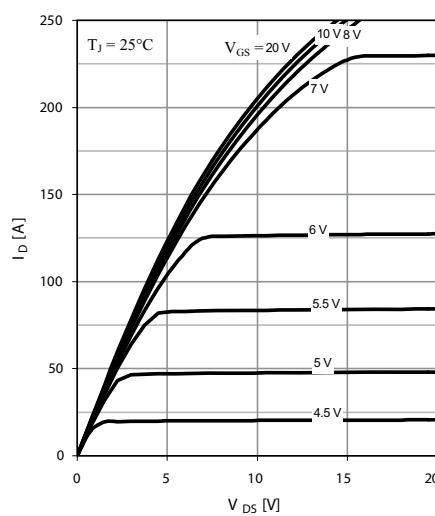

Fig. 2 Typ. output characteristics

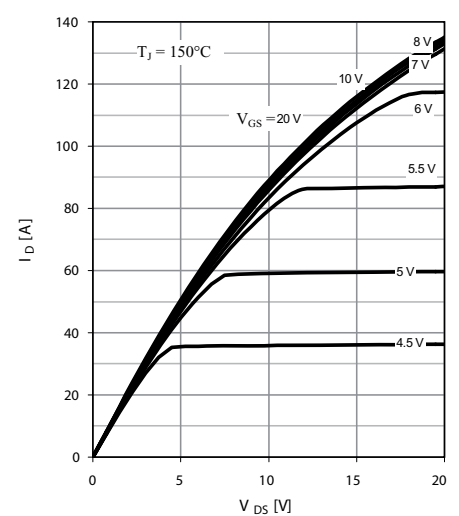

Fig. 3 Typ. output characteristics

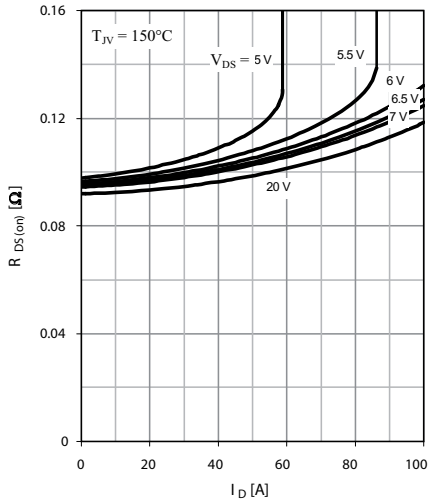

Fig. 4 Typ. drain-source on-state resistance characteristics of IGBT

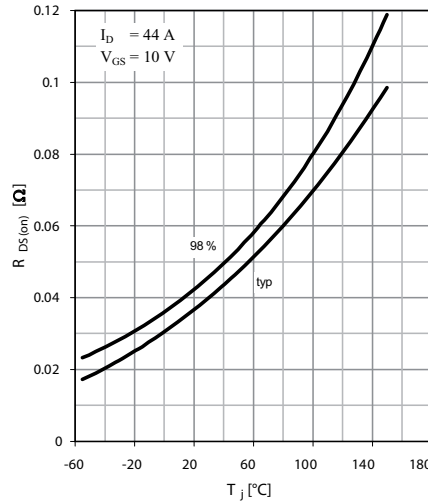

Fig. 5 Drain-source on-state resistance

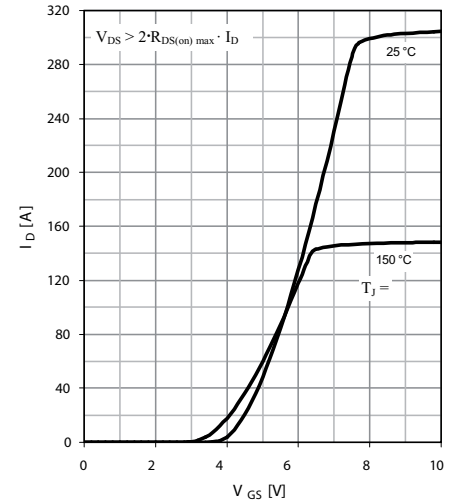

Fig. 6 Typ. transfer characteristics

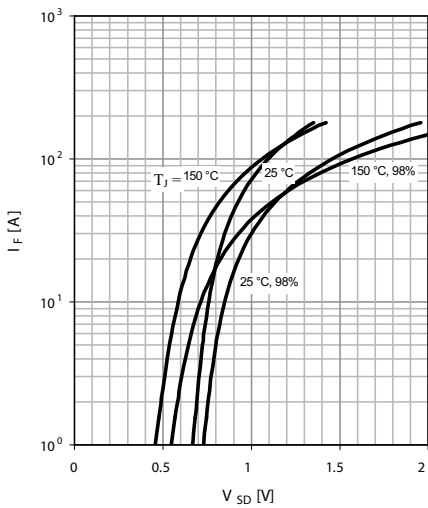

Fig. 7 Forward characteristic of reverse diode

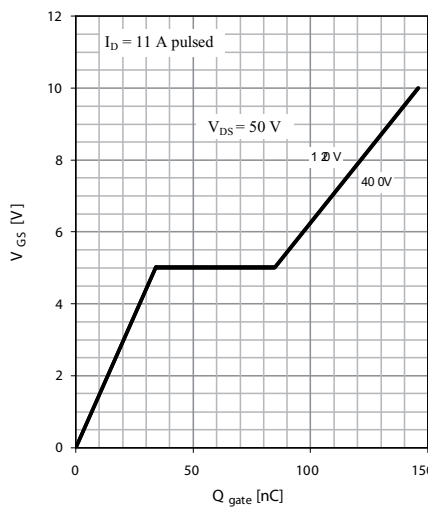

Fig. 8 Typ. gate charge

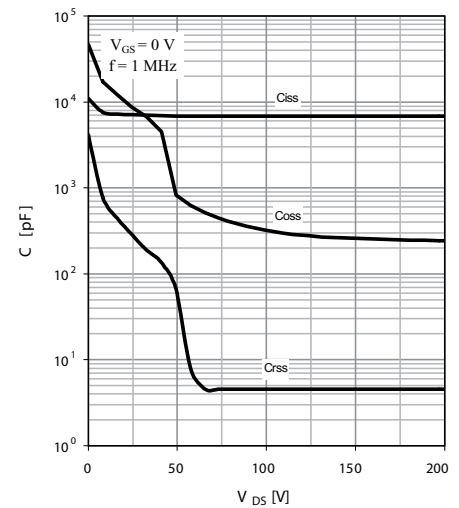

Fig. 9 Typ. capacitances

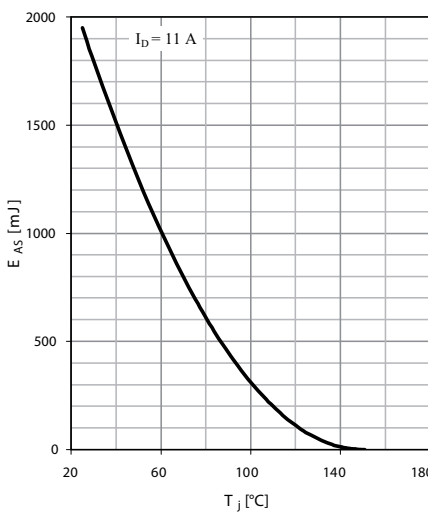

Fig. 10 Avalanche energy

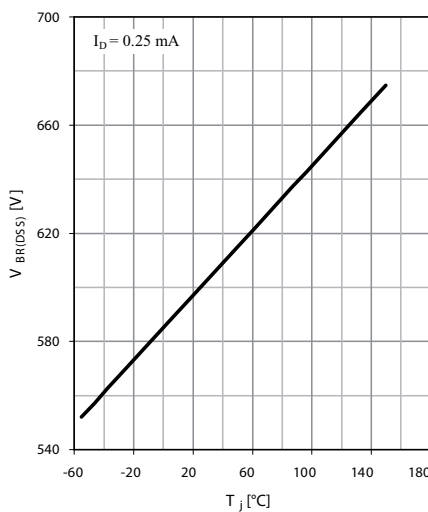

Fig. 11 Drain-source breakdown voltage

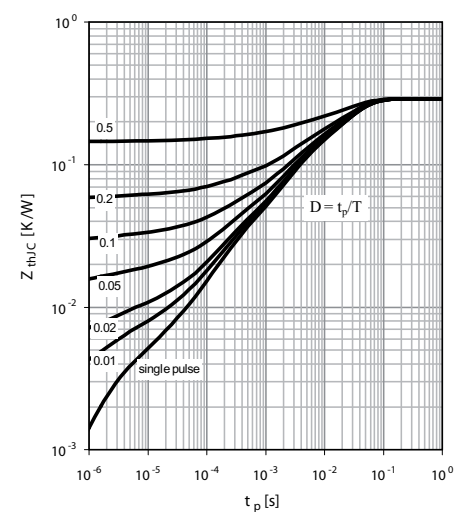

Fig. 12 Max. transient thermal impedance

IXYS reserves the right to change limits, test conditions and dimensions.

20090209d

# Mouser Electronics

Authorized Distributor

Click to View Pricing, Inventory, Delivery & Lifecycle Information:

[IXYS:](#)

[IXKH70N60C5](#)