



$V_{(BR)DSX} / V_{(BR)DGX}$	$R_{DS(on)}$ (max)	I_{DSS} (min)	Package
250V	4Ω	360mA	SOT-89

Features

- High Breakdown Voltage: 250V
- Low On-Resistance: 4Ω max. at 25°C
- Low $V_{GS(off)}$ Voltage: -1.6 to -3.9V
- Depletion Mode Device Offers Low $R_{DS(on)}$ at Cold Temperatures
- High Input Impedance
- Small Package Size: SOT-89

Applications

- Ignition Modules
- Normally-On Switches
- Solid State Relays
- Converters
- Telecommunications
- Power Supply

Description

The CPC3703 is an N-channel, depletion mode, field effect transistor (FET) that utilizes IXYS Integrated Circuits Division's proprietary third-generation vertical DMOS process. The third-generation process realizes world class, high voltage MOSFET performance in an economical silicon gate process. Our vertical DMOS process yields a robust device, with high input impedance, for use in high-power applications. The CPC3703 is a highly reliable device that has been used extensively in our Solid State Relays for industrial and telecommunications applications.

This device excels in power applications that require low drain-source resistance, particularly in cold environments such as automotive ignition modules. The CPC3703 offers a low, 4Ω maximum, on-state resistance at 25°C.

The CPC3703 has a minimum breakdown voltage of 250V, and is available in an SOT-89 package. As with all MOS devices, the FET structure prevents thermal runaway and thermal-induced secondary breakdown.

Ordering Information

Part #	Description
CPC3703CTR	N-Channel Depletion Mode FET, SOT-89 Pkg. Tape and Reel (1000/Reel)

Package Pinout

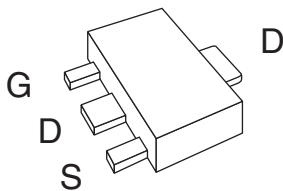

(SOT-89)

Circuit Symbol

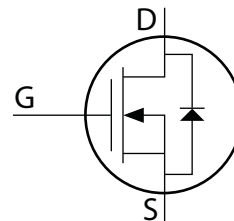

Absolute Maximum Ratings @ 25°C (Unless Otherwise Noted)

Parameter	Ratings	Units
Drain-to-Source Voltage	250	V _P
Gate-to-Source Voltage	±15	V _P
Pulsed Drain Current	600	mA
Total Package Dissipation ¹	1.1	W
Junction Temperature	125	°C
Operational Temperature, Ambient	-55 to +125	°C
Storage Temperature	-55 to +125	°C

Absolute Maximum Ratings are stress ratings. Stresses in excess of these ratings can cause permanent damage to the device. Functional operation of the device at conditions beyond those indicated in the operational sections of this data sheet is not implied.

¹ Mounted on 1"x1"x0.062" FR4 board.

Electrical Characteristics @ 25°C (Unless Otherwise Noted)

Parameter	Symbol	Conditions	Min	Typ	Max	Units
Drain-to-Source Breakdown Voltage	V _{(BR)DSX}	V _{GS} = -5V, I _D = 100µA	250	-	-	V
Gate-to-Source Off Voltage	V _{GS(off)}	V _{DS} = 5V, I _D = 1mA	-1.6	-	-3.9	V
Change in V _{GS(off)} with Temperature	dV _{GS(off)} /dT	V _{DS} = 5V, I _D = 1µA	-	-	4.5	mV/°C
Gate Body Leakage Current	I _{GSS}	V _{GS} = ±15V, V _{DS} = 0V	-	-	100	nA
Drain-to-Source Leakage Current	I _{D(off)}	V _{GS} = -5V, V _{DS} = 250V	-	-	1	µA
		V _{GS} = -5V, V _{DS} = 200V, T _A = 125°C	-	-	1	mA
Saturated Drain-to-Source Current	I _{DSS}	V _{GS} = 0V, V _{DS} = 15V	360	-	-	mA
Static Drain-to-Source On-State Resistance	R _{DS(on)}	V _{GS} = 0V, I _D = 200mA	-	-	4	Ω
Change in R _{DS(on)} with Temperature	dR _{DS(on)} /dT		-	-	1.1	%/°C
Forward Transconductance	G _{FS}	I _D = 100mA, V _{DS} = 10V	225	-	-	mS
Input Capacitance	C _{ISS}	V _{GS} = -5V V _{DS} = 25V f = 1MHz	-	327	350	pF
Common Source Output Capacitance	C _{OSS}		51	65		
Reverse Transfer Capacitance	C _{RSS}		27	35		
Turn-On Delay Time	t _{d(on)}	V _{DD} = 25V I _D = 150mA V _{GS} = 0V to -10V R _{gen} = 50Ω	-	23	35	ns
Rise Time	t _r		8	20		
Turn-Off Delay Time	t _{d(off)}		17	25		
Fall Time	t _f		70	80		
Source-Drain Diode Voltage Drop	V _{SD}	V _{GS} = -5V, I _{SD} = 150mA	-	0.6	1.8	V
Thermal Resistance (Junction to Ambient)	R _{θJA}	-	-	90	-	°C/W

Switching Waveform & Test Circuit

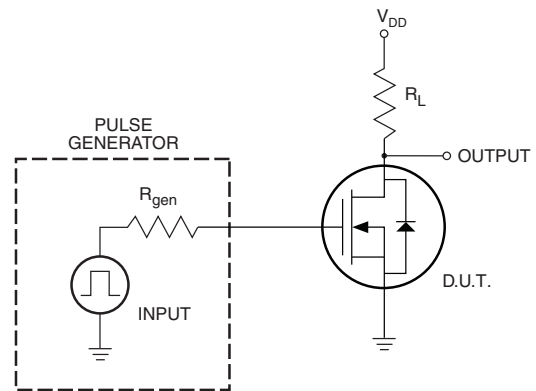
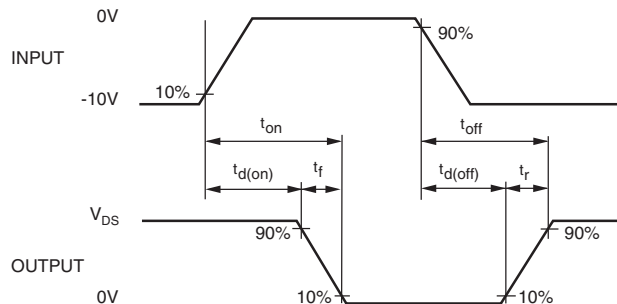

PERFORMANCE DATA (@25°C Unless Otherwise Noted)*

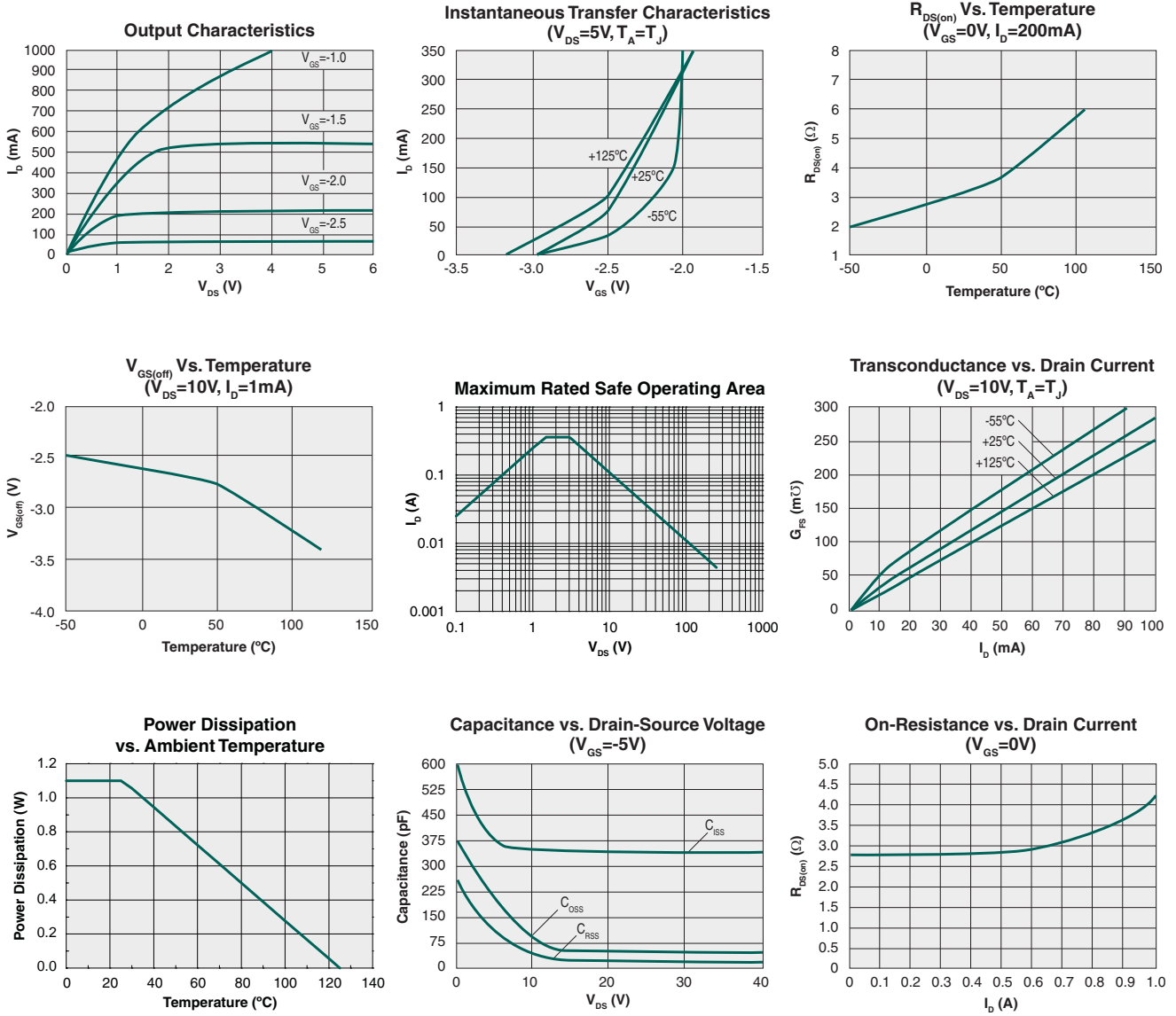

*The Performance data shown in the graphs above is typical of device performance. For guaranteed parameters not indicated in the written specifications, please contact our application department.

Manufacturing Information

Moisture Sensitivity



All plastic encapsulated semiconductor packages are susceptible to moisture ingress. IXYS Integrated Circuits Division classified all of its plastic encapsulated devices for moisture sensitivity according to the latest version of the joint industry standard, **IPC/JEDEC J-STD-020**, in force at the time of product evaluation. We test all of our products to the maximum conditions set forth in the standard, and guarantee proper operation of our devices when handled according to the limitations and information in that standard as well as to any limitations set forth in the information or standards referenced below.

Failure to adhere to the warnings or limitations as established by the listed specifications could result in reduced product performance, reduction of operable life, and/or reduction of overall reliability.

This product carries a **Moisture Sensitivity Level (MSL) rating** as shown below, and should be handled according to the requirements of the latest version of the joint industry standard **IPC/JEDEC J-STD-033**.

Device	Moisture Sensitivity Level (MSL) Rating
CPC3703C	MSL 1

ESD Sensitivity



This product is **ESD Sensitive**, and should be handled according to the industry standard **JESD-625**.

Reflow Profile

This product has a maximum body temperature and time rating as shown below. All other guidelines of **J-STD-020** must be observed.

Device	Maximum Temperature x Time
CPC3703C	260°C for 30 seconds

Board Wash

IXYS Integrated Circuits Division recommends the use of no-clean flux formulations. However, board washing to remove flux residue is acceptable, and the use of a short drying bake may be necessary. Chlorine-based or Fluorine-based solvents or fluxes should not be used. Cleaning methods that employ ultrasonic energy should not be used.



Mechanical Dimensions

CPC3703C

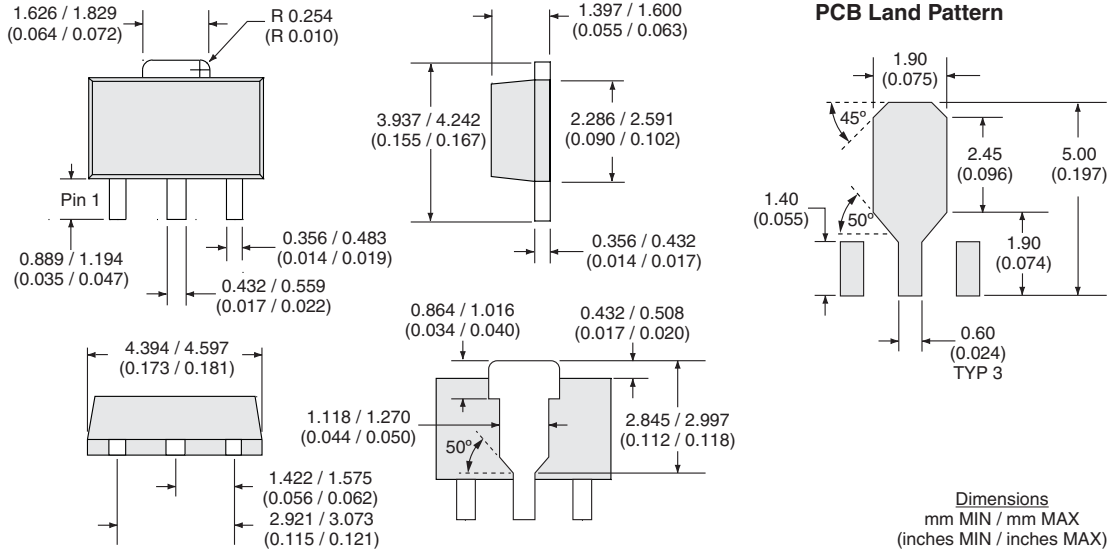

CPC3703CTR Tape & Reel

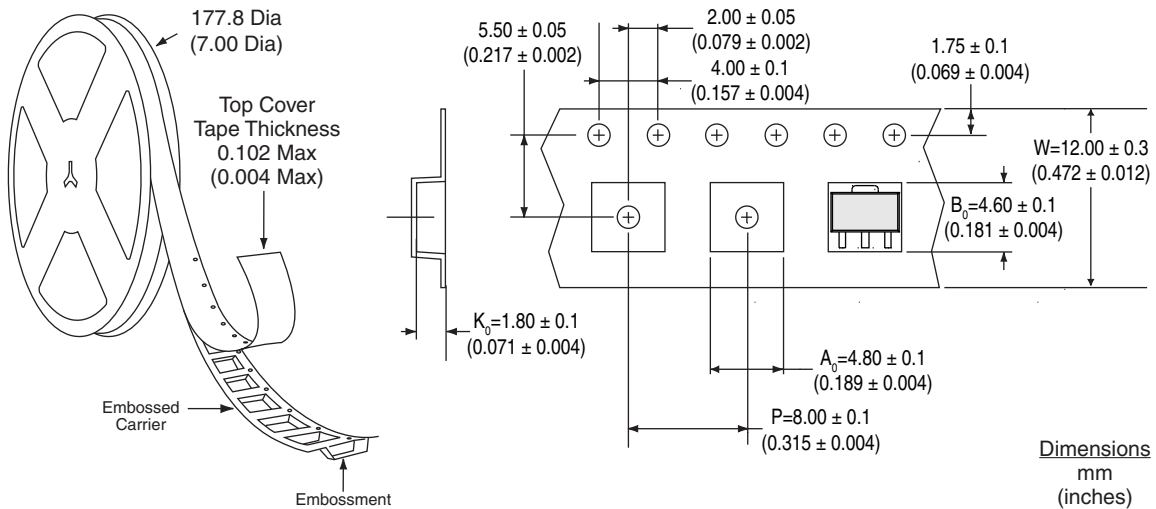

For additional information please visit our website at: www.ixysic.com

IXYS Integrated Circuits Division makes no representations or warranties with respect to the accuracy or completeness of the contents of this publication and reserves the right to make changes to specifications and product descriptions at any time without notice. Neither circuit patent licenses nor indemnity are expressed or implied. Except as set forth in IXYS Integrated Circuits Division's Standard Terms and Conditions of Sale, IXYS Integrated Circuits Division assumes no liability whatsoever, and disclaims any express or implied warranty, relating to its products including, but not limited to, the implied warranty of merchantability, fitness for a particular purpose, or infringement of any intellectual property right.

The products described in this document are not designed, intended, authorized or warranted for use as components in systems intended for surgical implant into the body, or in other applications intended to support or sustain life, or where malfunction of IXYS Integrated Circuits Division's product may result in direct physical harm, injury, or death to a person or severe property or environmental damage. IXYS Integrated Circuits Division reserves the right to discontinue or make changes to its products at any time without notice.

Mouser Electronics

Authorized Distributor

Click to View Pricing, Inventory, Delivery & Lifecycle Information:

[IXYS:](#)

[CPC3703CTR](#)