



# MIC23201

## 2MHz PWM 2A Buck Regulator with Hyper Speed Control™

### General Description

The MIC23201 is a high efficiency 2MHz 2A synchronous buck regulator with Hyper Speed Control. Micrel's Hyper Speed Control provides ultra-fast transient response which is perfectly suited for supplying processor core voltages. An additional benefit of this proprietary architecture is very low output ripple voltage throughout the entire load range with the use of small output capacitors. The tiny 3mm x 3mm MLF® package saves precious board space and requires only three external components.

The MIC23201 is designed for use with a very small inductor, down to 1µH, and an output capacitor as small as 22µF that enables a total solution size, less than 1.5mm height.

The MIC23201 provides a constant switching frequency around 2MHz while achieving peak efficiencies up to 90%.

The MIC23201 is available in 10-pin 3mm x 3mm MLF package with an operating junction temperature range from -40°C to +125°C.

Datasheets and support documentation can be found on Micrel's web site at: [www.micrel.com](http://www.micrel.com).

### Features

- Input voltage: 2.7V to 5.5V
- 2A output current
- Up to 90% peak efficiency
- Programmable Soft-Start
- Power Good Indicator
- 2MHz switching frequency
- Safe for pre-biased output
- Ultra fast transient response
- Low voltage output ripple, 16mV at full load
- Fully integrated MOSFET switches
- 0.01µA shutdown current
- Thermal shutdown and current limit protection
- Output Voltage as low as 0.95V
- 10-pin 3mm x 3mm MLF
- -40°C to +125°C operating junction temperature range

### Applications

- Low Voltage Point of Load
- Blu Ray DVD Players
- Networking Equipment
- Set Top Boxes

### Typical Application

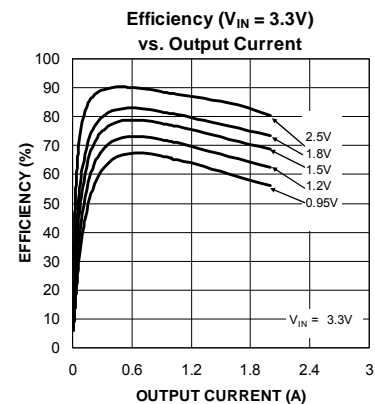
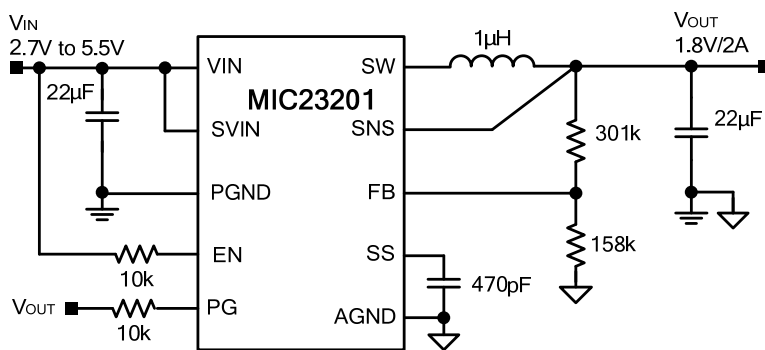

Hyper Speed Control is a trademark of Micrel, Inc.  
MLF and MicroLeadFrame are registered trademark Amkor Technology Inc.

Micrel Inc. • 2180 Fortune Drive • San Jose, CA 95131 • USA • tel +1 (408) 944-0800 • fax +1 (408) 474-1000 • <http://www.micrel.com>

## Ordering Information

Part Number	Marking Code	Nominal Output Voltage	Package	Junction Temp. Range	Lead Finish
MIC23201YML	201A	ADJ	10-pin 3mm x 3mm MLF	-40°C to +125°C	Pb-Free

### Notes:

- Other options available. Contact Micrel for details.
- MLF is GREEN RoHS compliant package. Lead finish is NiPdAu. Mold compound is Halogen Free.

## Pin Configuration

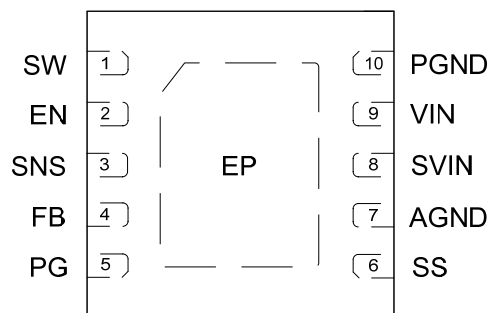

**10 Pin 3mm x 3mm MLF (ML)  
(Top View)**

## Pin Description

Pin Number	Pin Name	Pin Function
1	SW	Switch output: Internal power MOSFET output switches.
2	EN	Enable input: Logic high enables operation of the regulator. Logic low will shut down the device. Do not leave floating.
3	SNS	Sense input: Connect to $V_{OUT}$ as close to output capacitor as possible to sense output voltage.
4	FB	Feedback input: The FB pin is regulated to 0.62V. Connect a resistor divider from the output to ground to set the output voltage.
5	PG	Power Good output: Open Drain output for the power good indicator. Place a resistor between this pin and a voltage source to detect a power good condition.
6	SS	Soft Start: Place a capacitor from SS pin to ground to program the soft start time. Do not leave this pin floating. Minimum of 100pF $C_{SS}$ is required.
7	AGND	Analog Ground: Connect to central ground point where all high current paths meet ( $C_{IN}$ , $C_{OUT}$ , PGND) for best operation.
8	SVIN	Signal input voltage: This pin is connected externally to the VIN pin. A 2.2 $\mu$ F ceramic capacitor from the SVIN pin to AGND must be placed next to the IC.
9	VIN	Power supply input voltage: The VIN pin is the input supply to the internal P-Channel Power MOSFET. A 22 $\mu$ F ceramic is recommended for bypassing at VIN pin.
10	PGND	Power Ground.
EP	ePad	Thermal pad. It must be connected to PGND on the PCB to improve the thermal performance.

**Absolute Maximum Ratings** <sup>(1)</sup>

Supply Voltage (VIN, SVIN).....	6V
Sense (VSNS).....	6V
Power Good (PG).....	6V
Output Switch Voltage .....	6V
Enable Input Voltage (VEN).....	-0.3V to VIN
Storage Temperature Range.....	-65°C to +150°C
ESD Rating <sup>(3)</sup> .....	1kV

**Operating Ratings** <sup>(2)</sup>

Supply Voltage (VIN) .....	2.7V to 5.5V
Enable Input Voltage (VEN) ..	0V to VIN
Output Voltage Range (VSNS) ..	0.95V to 3.6V
Junction Temperature Range (TJ) .....	-40°C ≤ TJ ≤ +125°C
Thermal Resistance	
3mm x 3mm MLF-10 (θJA) .....	60.7°C/W
3mm x 3mm MLF-10 (θJC) .....	28.7°C/W

**Electrical Characteristics** <sup>(4)</sup>

TA = 25°C; VIN = VEN = 3.3V; L = 1.0μH; COUT = 22μF unless otherwise specified. **Bold** values indicate -40°C ≤ TJ ≤ +125°C, unless noted.

Parameter	Condition	Min	Typ	Max	Units
Supply Voltage Range		<b>2.7</b>		<b>5.5</b>	V
Under-Voltage Lockout Threshold	VIN Rising	<b>2.45</b>	2.55	<b>2.65</b>	V
Under-Voltage Lockout Hysteresis			200		mV
Quiescent Current	IOUT = 0mA, SNS > 1.2 * VOUT Nominal		1.15	<b>3.35</b>	mA
Shutdown Current	VEN = 0V; VIN = 5.5V		1.34	<b>5</b>	μA
Feedback Voltage	ILOAD = 20mA	<b>0.604</b>	0.62	<b>0.635</b>	V
Feedback Bias Current			1		μA
Current Limit	SNS = 0.9*VOUTNOM	<b>2.3</b>	4.4		A
Output Voltage Line Regulation	VIN = 3.6V to 5.5V if VOUTNOM < 2.5V, ILOAD = 20mA		0.3		%/V
	VIN = 4.5V to 5.5V if VOUTNOM ≥ 2.5V, ILOAD = 20mA				
Output Voltage Load Regulation	20mA < ILOAD < 500mA, VIN = 3.6V if VOUTNOM < 2.5V		0.46		%
	20mA < ILOAD < 500mA, VIN = 5.0V if VOUTNOM ≥ 2.5V				
	20mA < ILOAD < 1A, VIN = 3.6V if VOUTNOM < 2.5V		0.71		%
	20mA < ILOAD < 1A, VIN = 5.0V if VOUTNOM ≥ 2.5V				
PWM Switch ON-Resistance	ISW = 100mA PMOS		0.200		Ω
	ISW = -100mA NMOS		0.190		
Switching Frequency	IOUT = 120mA		2		MHz
Maximum Duty Cycle	VFB = 0V	80			%
Soft Start Time	VOUT = 90%, CSS=470pF		300		μs
Soft Start Current	VSS = 0V		2.7		μA
Power Good Threshold (Rising)	% of VNOMINAL	85	90	95	%
Power Good Hysteresis			7		%
Power Good Delay			68		μs
Power Good Pull Down Resistance	IPG = 250μA		85		Ω
Enable Threshold	Turn-On	<b>0.5</b>	0.9	<b>1.2</b>	V
Enable Input Current			0.1	<b>2</b>	μA
Over Temperature Shutdown	TJ Rising		160		°C
Over Temperature Shutdown Hysteresis			20		°C

**Notes:**

1. Exceeding the absolute maximum rating may damage the device.
2. The device is not guaranteed to function outside its operating rating.
3. Devices are ESD sensitive. Handling precautions recommended. Human body model, 1.5kΩ in series with 100pF.
4. Specification for packaged product only.

# Typical Characteristics

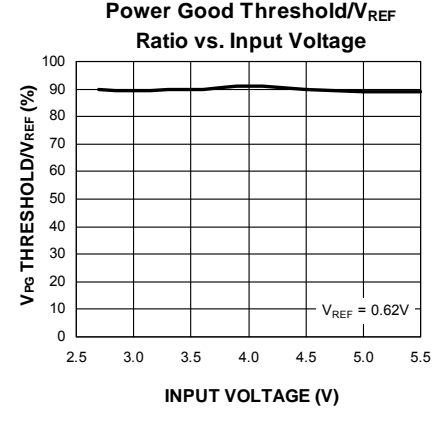
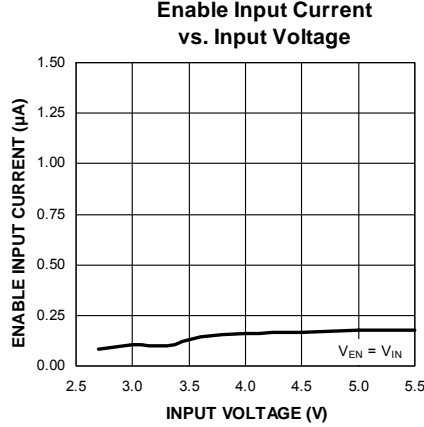
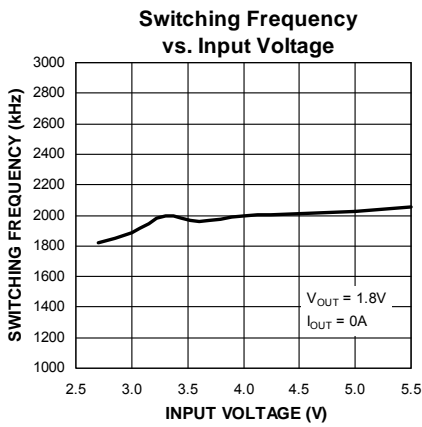
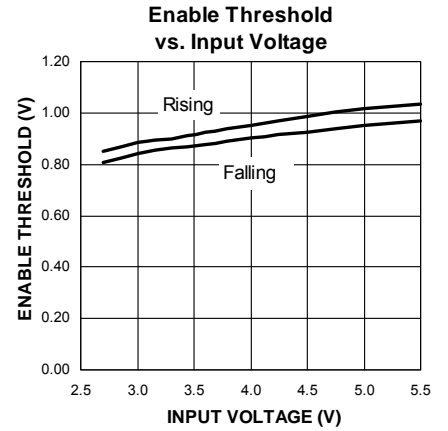
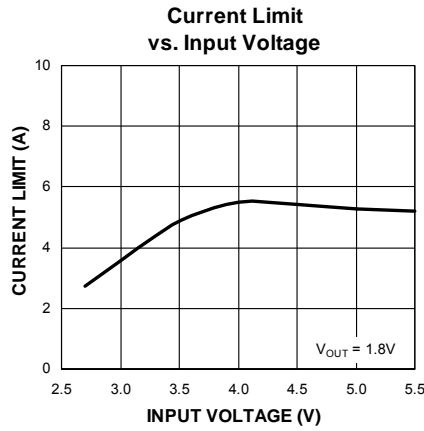
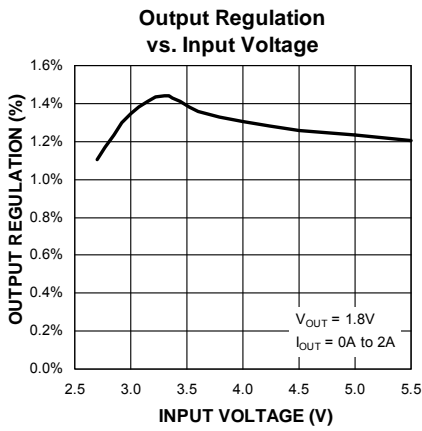
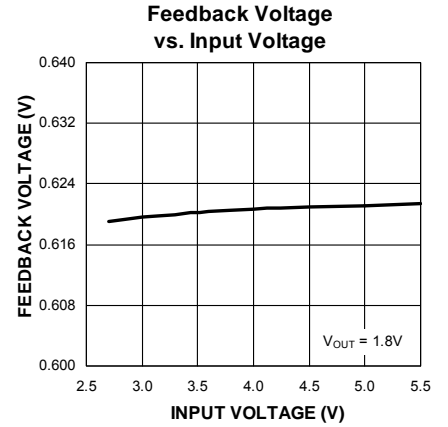
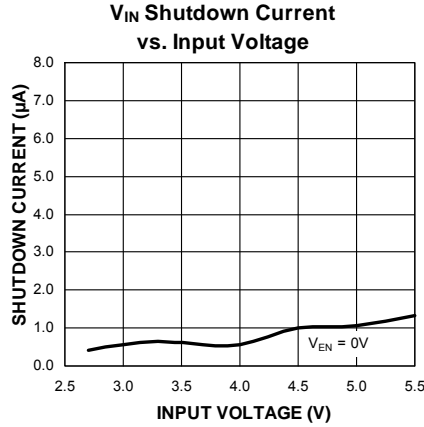
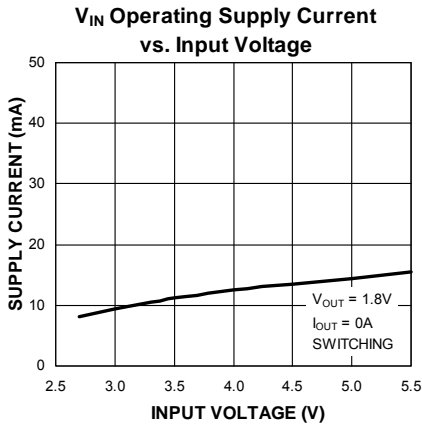

## Typical Characteristics (Continued)

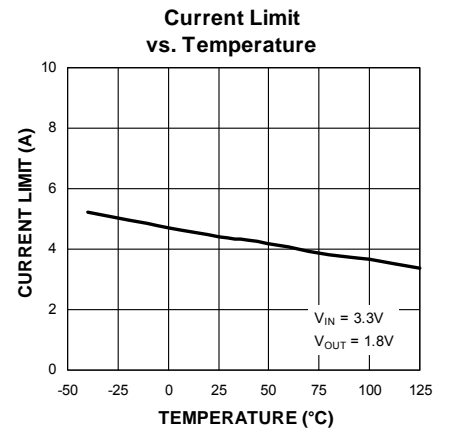
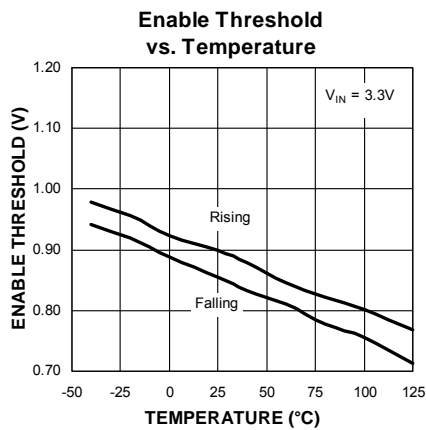
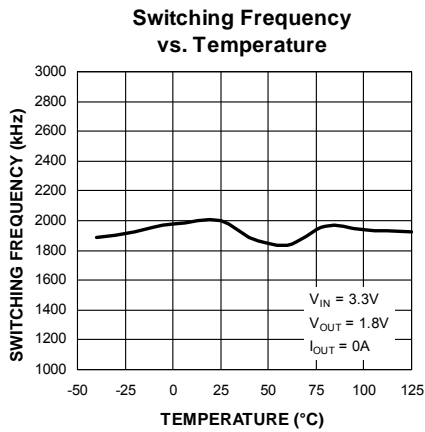
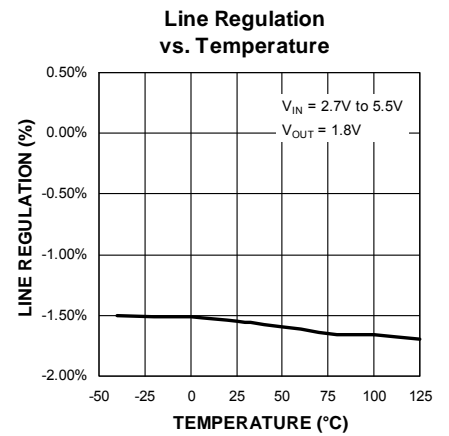
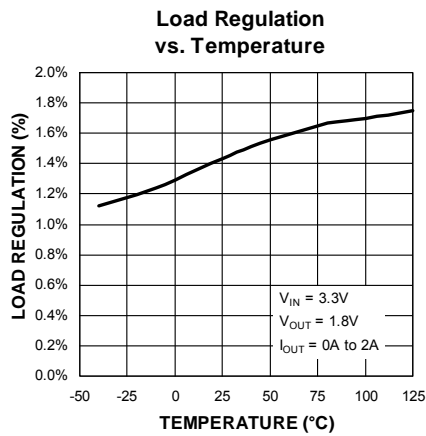
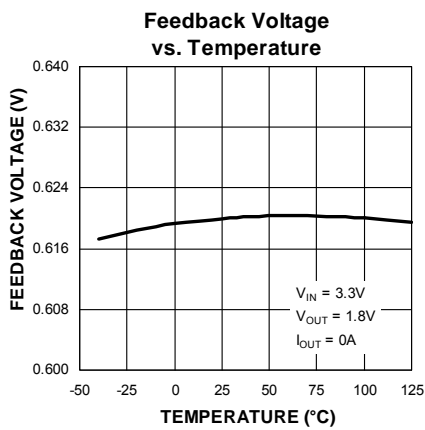
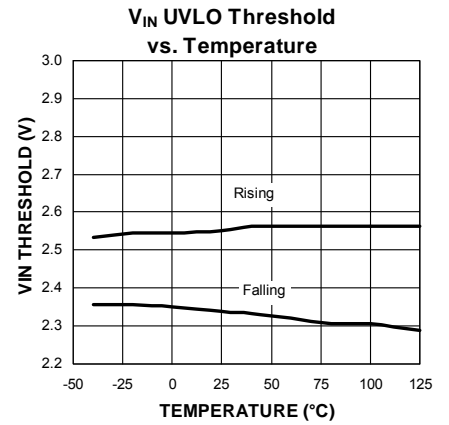
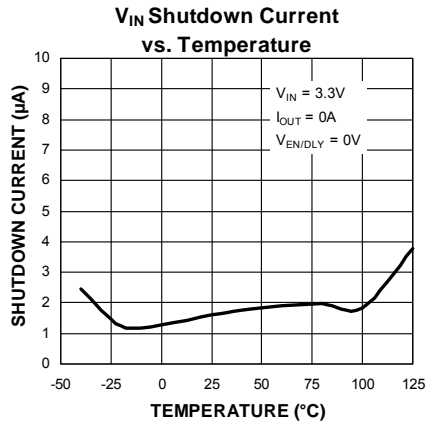
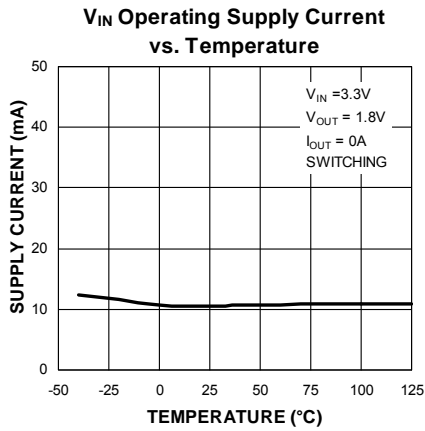

# Typical Characteristics (Continued)

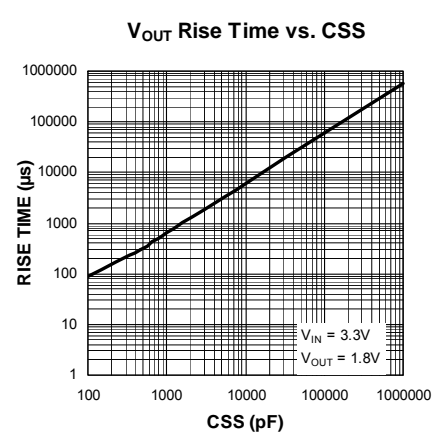
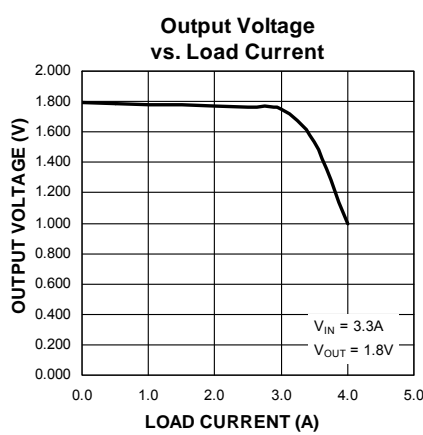
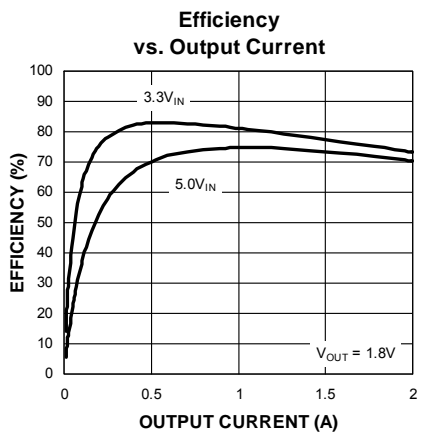
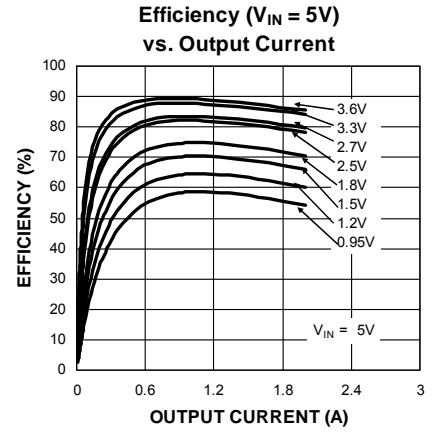
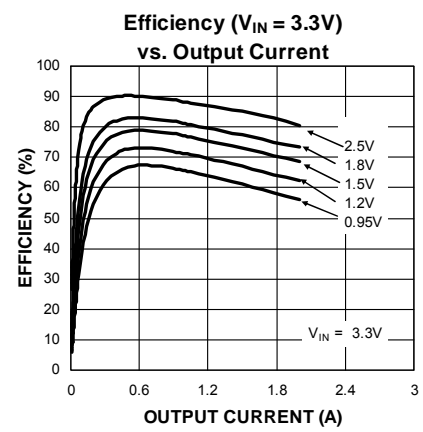
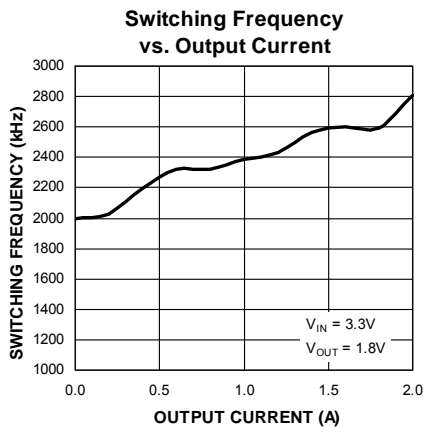
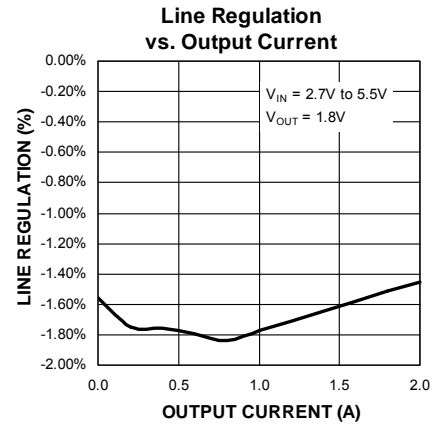
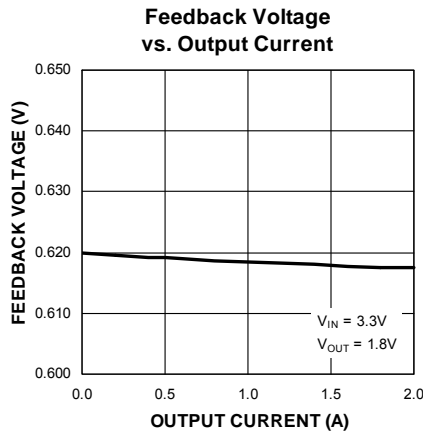
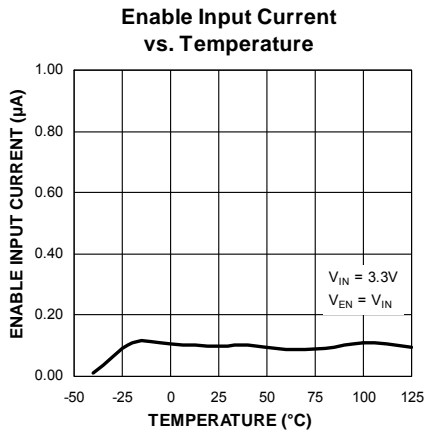

## Typical Characteristics (Continued)

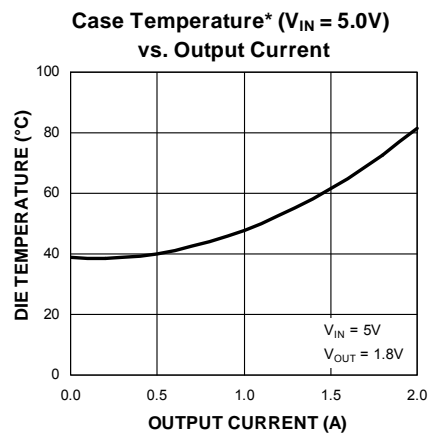
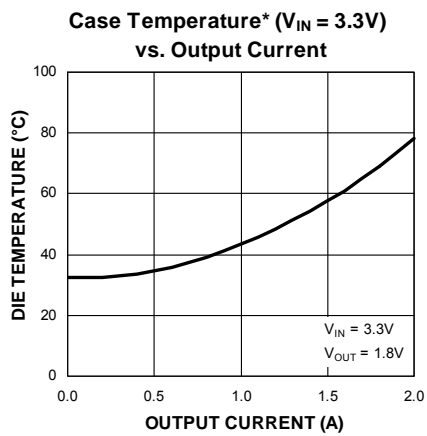

**Die Temperature\*** : The temperature measurement was taken at the hottest point on the MIC23201 case and mounted on a 1.4-square inch PCB (see *Thermal Measurements* section). Actual results will depend upon the size of the PCB, ambient temperature, and proximity to other heat-emitting components.

## Functional Characteristics

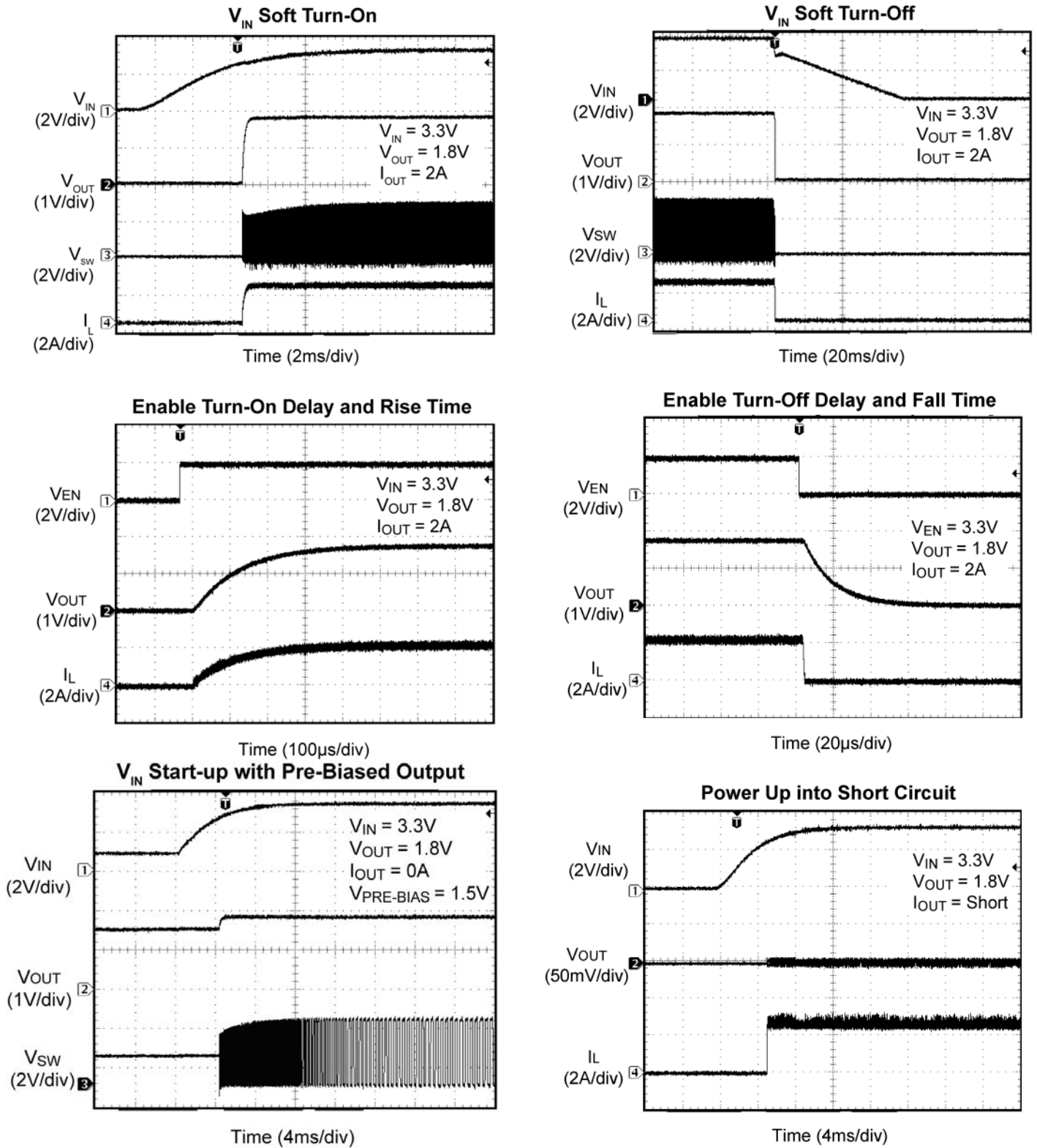



### Functional Characteristics (Continued)

Enabled into Short

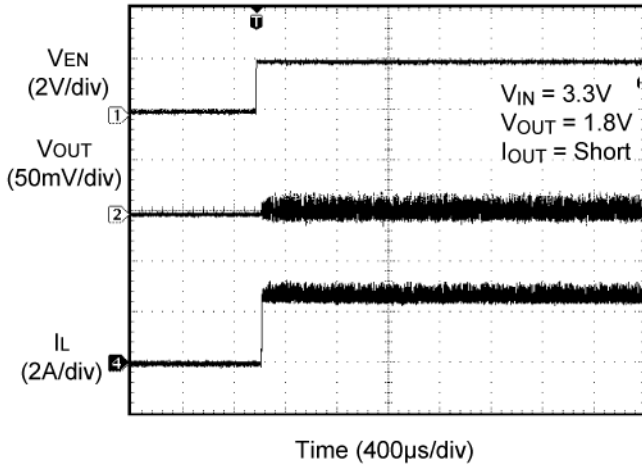

Short Circuit

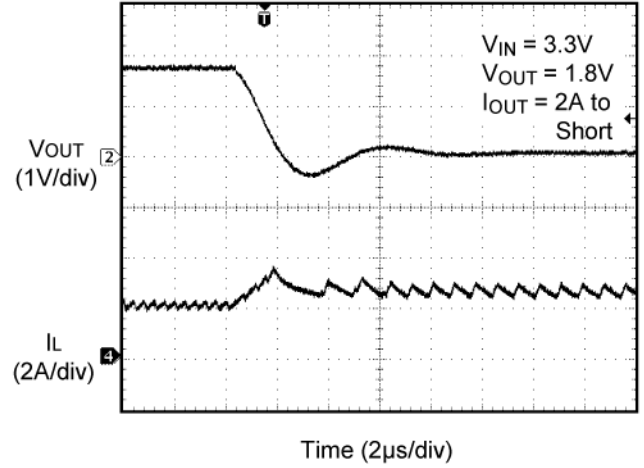

Output Recovery from Short Circuit

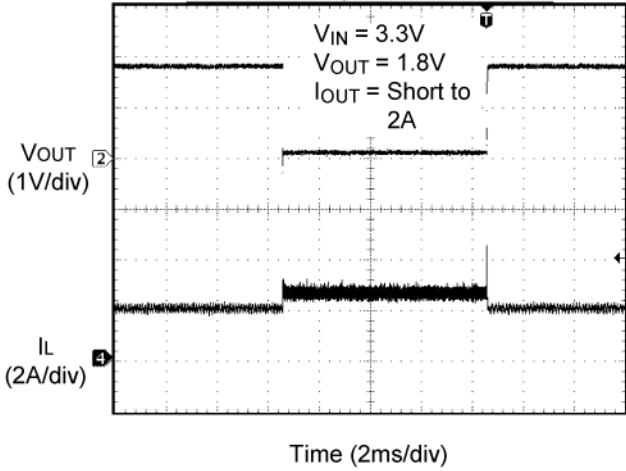

Output Peak Current Limit Threshold

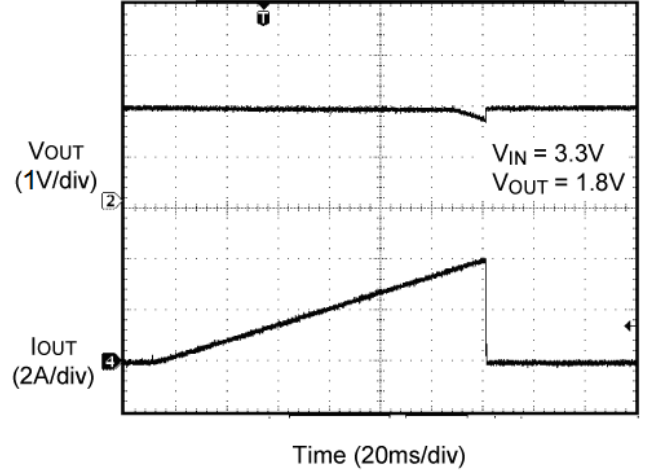

Output Recovery from Thermal Shutdown

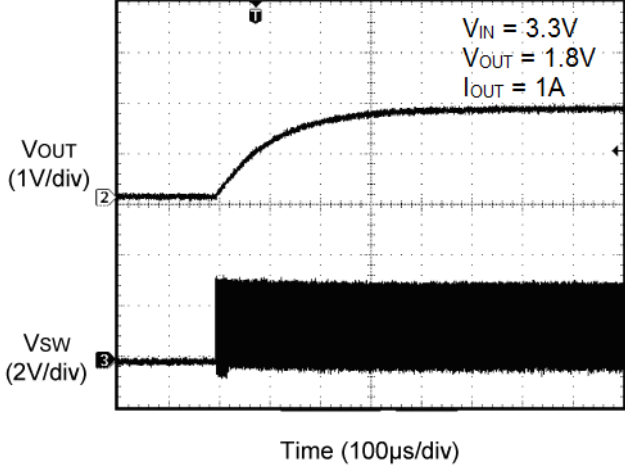

Switching Waveforms;  $I_{OUT} = 2A$

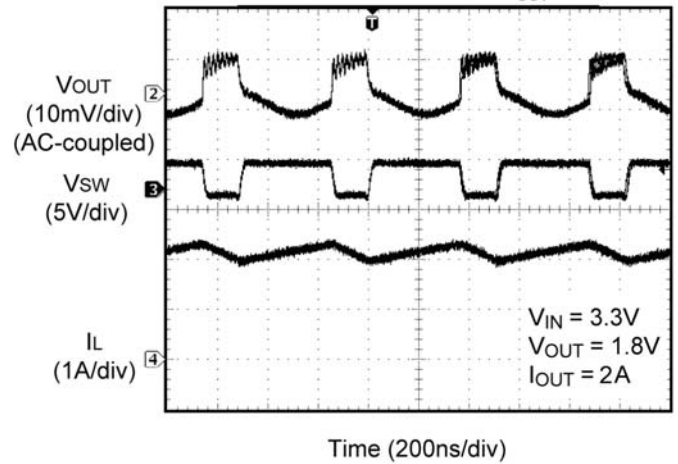

### Functional Characteristics (Continued)

#### Switching Waveforms; $I_{OUT} = 0A$

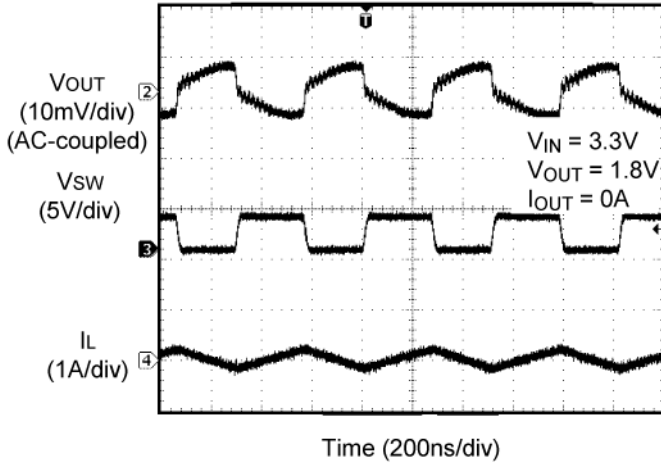

#### Load Transient Response

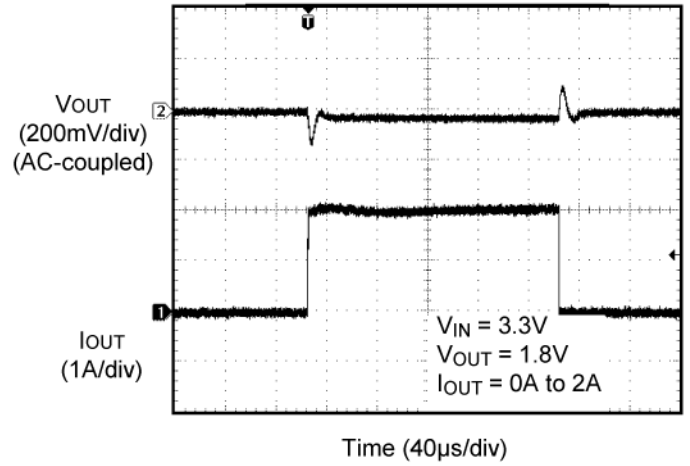

#### Line Transient Response

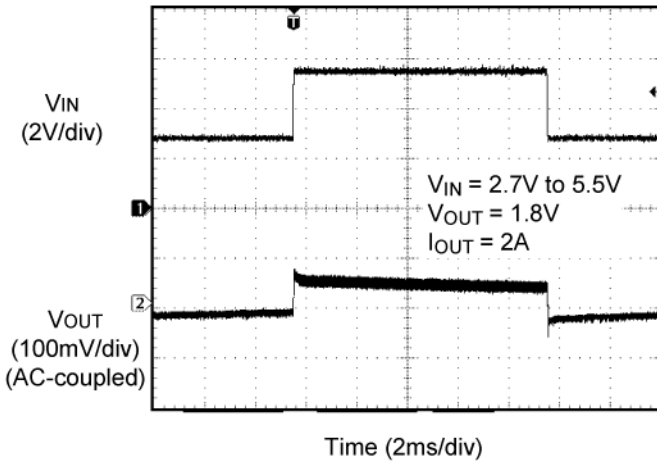

#### Power Good at $V_{IN}$ Soft Turn-On

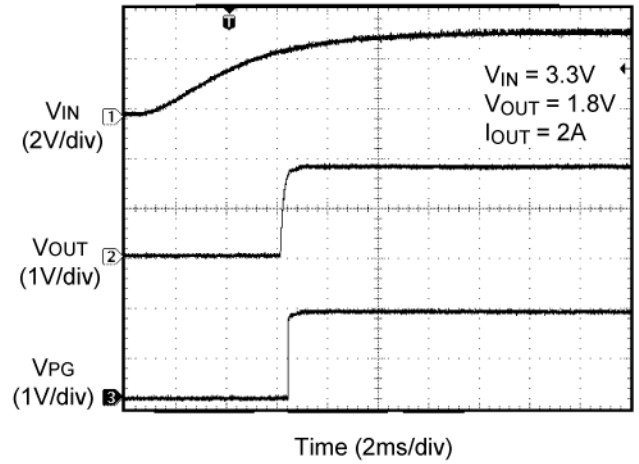

#### Power Good at $V_{IN}$ Soft Turn-Off

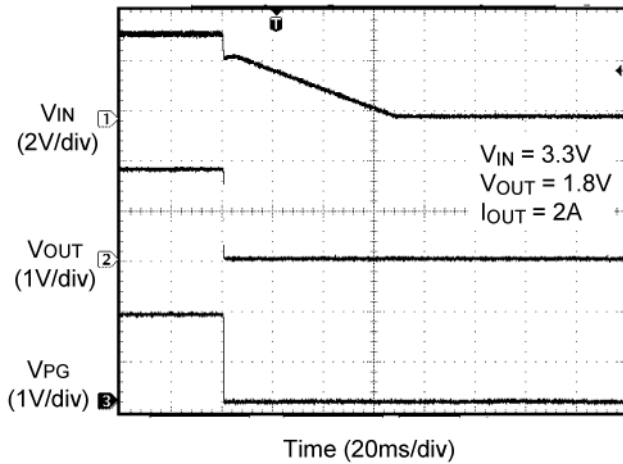

#### Power Good Response under Load Transient

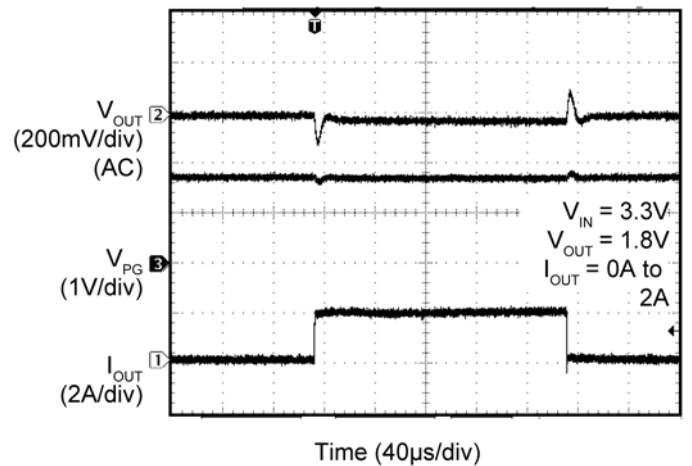

## Functional Diagram

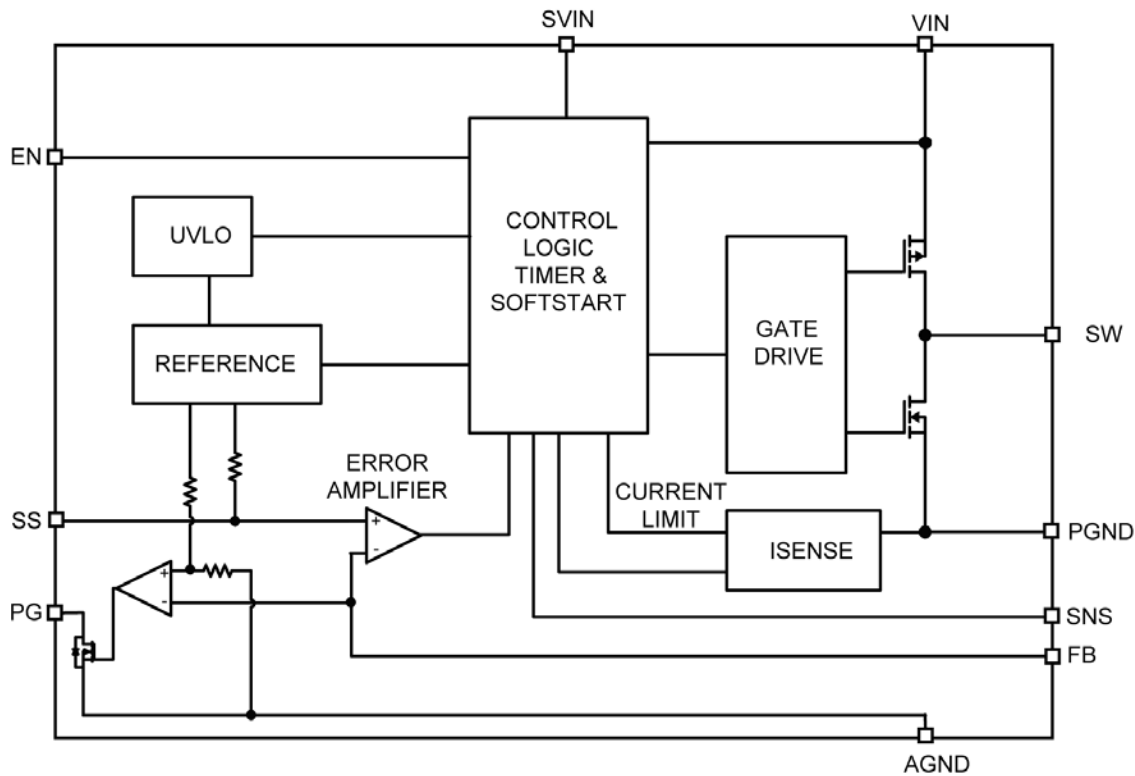

Figure 1. Simplified MIC23201 Functional Block Diagram

## Functional Description

### VIN

The input supply (VIN) provides power to the internal MOSFETs for the switch mode regulator along with the internal control circuitry. The VIN operating range is 2.7V to 5.5V so an input capacitor, with a minimum voltage rating of 6.3V, is recommended. Due to the high switching speed, 22 $\mu$ F bypass capacitor placed close to VIN and the power ground (PGND) pin is required. Refer to the layout recommendations for details.

### SVIN

The input supply (SVIN) provides power to internal control circuitry. This pin is connected externally to the VIN pin. A 2.2 $\mu$ F ceramic capacitor from the SVIN pin to AGND must be placed next to the IC.

### EN

A logic high signal on the enable pin activates the output voltage of the device. A logic low signal on the enable pin deactivates the output and reduces supply current to 0.01 $\mu$ A. MIC23201 features built-in soft-start circuitry that reduces in-rush current and prevents the output

voltage from overshooting at start up. Do not leave this pin floating.

### SW

The switch (SW) connects directly to one end of the inductor and provides the current path during switching cycles. The other end of the inductor is connected to the load, SNS pin and output capacitor. Due to the high speed switching on this pin, the switch node should be routed away from sensitive nodes whenever possible.

### SS

The soft start (SS) pin is used to control the output voltage ramp up time. The approximate equation for the ramp time in seconds is  $270 \times 10^3 \times \ln(10) \times C_{SS}$ . For example, for a  $C_{SS} = 470\text{pF}$ ,  $T_{\text{rise}} \sim 300\mu\text{s}$ . See the Typical Characteristics curve for a graphical guide. The minimum recommended value for  $C_{SS}$  is 100pF.

### SNS

The sense (SNS) pin is connected to the output of the device to provide feedback to the control circuitry. The

SNS connection should be placed close to the output capacitor. Refer to the layout recommendations for more details.

**AGND**

The analog ground (AGND) is the ground path for the biasing and control circuitry. The current loop for the signal ground should be separate from the power ground (PGND) loop. Refer to the layout recommendations for more details.

**PGND**

The power ground pin is the ground path for the high current. The current loop for the power ground should be as small as possible and separate from the analog ground (AGND) loop as applicable. Refer to the layout recommendations for more details.

**FB**

The FB pin is regulated to 0.62V. A resistor divider connecting the feedback to the output is used to adjust the desired output voltage. A resistor divider network is connected to this pin from the output and is compared to

the internal 0.62V reference within the regulation loop. The output voltage can be programmed using the following equation:

$$V_{\text{OUT}} = V_{\text{REF}} \times \left( 1 + \frac{R1}{R2} \right)$$

where:

R1 is the top resistor, R2 is the bottom resistor. The output voltage can be adjusted from 0.95V to 3.6V.

**PG**

The power good (PG) pin is an open drain output which indicates logic high when the output voltage is typically above 87% of its steady state voltage. A pull-up resistor of more than 5kΩ should be connected from PG to V<sub>OUT</sub>.

## Application Information

The MIC23201 is a high performance DC/DC step down regulator offering a small solution size. Supporting an output current up to 2A inside a tiny 3mm x 3mm MLF package and requiring only three external components, the MIC23201 is able to maintain high efficiency throughout the entire load range while providing ultra-fast load transient response. The following sections provide additional device application information.

### Input Capacitor

A minimum of 4.7µF ceramic capacitor or greater should be placed close to the VIN pin and PGND / GND pin for bypassing but the recommended value of input capacitor is 22µF. A X5R or X7R temperature rating is recommended for the input capacitor. Y5V temperature rating capacitors, aside from losing most of their capacitance over temperature, can also become resistive at high frequencies. This reduces their ability to filter out high frequency noise.

### Output Capacitor

The MIC23201 was designed for use with a minimum of 4.7µF or greater ceramic output capacitor. Increasing the output capacitance will lower output ripple and improve load transient response but could increase solution size or cost. The recommended value of output capacitor is 22µF. A low equivalent series resistance (ESR) ceramic output capacitor is recommended based upon performance, size and cost. Both the X7R or X5R temperature rating capacitors are recommended. The Y5V and Z5U temperature rating capacitors are not recommended due to their wide variation in capacitance over temperature and increased resistance at high frequencies.

### Inductor Selection

When selecting an inductor, it is important to consider the following factors (not necessarily in the order of importance):

- Inductance
- Rated current value
- Size requirements
- DC resistance (DCR)

The MIC23201 was designed for use with a 1µH to 2.2µH inductor. For faster transient response, a 1µH inductor will yield the best result. For lower output ripple, a 2.2µH inductor is recommended.

Maximum current ratings of the inductor are generally given in two methods; permissible DC current and saturation current. Permissible DC current can be rated either for a 40°C temperature rise or a 10% to 20% loss in inductance. Ensure the inductor selected can handle the maximum operating current. When saturation current is specified, make sure that there is enough margin so that the peak current does not cause the inductor to saturate. Peak current can be calculated as follows:

$$I_{PEAK} = \left[ I_{OUT} + V_{OUT} \left( \frac{1 - V_{OUT}/V_{IN}}{2 \times f \times L} \right) \right]$$

As shown by the calculation above, the peak inductor current is inversely proportional to the switching frequency and the inductance; the lower the switching frequency or the inductance the higher the peak current. As input voltage increases, the peak current also increases.

The size of the inductor depends on the requirements of the application. Refer to the Typical Application Circuit and Bill of Materials for details.

DC resistance (DCR) is also important. While DCR is inversely proportional to size, DCR can represent a significant efficiency loss. Refer to the Efficiency Considerations.

### Compensation

The MIC23201 is designed to be stable with a 1µH to 2.2µH inductor with a minimum of 4.7µF ceramic (X5R) output capacitor.

### Efficiency Considerations

Efficiency is defined as the amount of useful output power, divided by the amount of power supplied.

$$\text{Efficiency \%} = \left( \frac{V_{OUT} \times I_{OUT}}{V_{IN} \times I_{IN}} \right) \times 100$$

Maintaining high efficiency serves two purposes. It reduces power dissipation in the power supply, reducing the need for heat sinks and thermal design considerations and it reduces consumption of current for battery powered applications. Reduced current draw from a battery increases the devices operating time and is critical in hand held devices.

There are two types of losses in switching converters; DC losses and switching losses. DC losses are simply the power dissipation of  $I^2R$ . Power is dissipated in the high side switch during the on cycle. Power loss is equal to the high side MOSFET  $R_{DS(ON)}$  multiplied by the RMS Switch Current squared. During the off cycle, the low side N-channel MOSFET conducts, also dissipating power. Device operating current also reduces efficiency. The product of the quiescent (operating) current and the supply voltage represents another DC loss. The current required driving the gates on and off at a constant 2MHz frequency and the switching transitions make up the switching losses.

All but the inductor losses are inherent to the device. In which case, inductor selection becomes increasingly critical in efficiency calculations. As the inductors are reduced in size, the DC resistance (DCR) can become quite significant. The DCR losses can be calculated as follows:

$$P_{DCR} = I_{OUT}^2 \times DCR$$

From that, the loss in efficiency due to inductor resistance can be calculated as follows:

$$\text{Efficiency Loss} = \left[ 1 - \left( \frac{V_{OUT} \times I_{OUT}}{V_{OUT} \times I_{OUT} + P_{DCR}} \right) \right] \times 100$$

Efficiency loss due to DCR is minimal at light loads and gains significance as the load is increased. Inductor selection becomes a trade-off between efficiency and size in this case.

### Thermal Considerations

The MIC23201 is provided in a 3mm x 3mm MLF package – a package that has very good thermal-performance. This package maximizes heat transfer from the junction to the exposed pad (EP), which connects to the ground plane. The size of the ground plane attached to the exposed pad determines the overall thermal resistance from the junction to the ambient air surrounding the printed circuit board. The junction temperature for a given ambient temperature can be calculated using:

$$T_J = T_{AMB} + P_{DISS} \times \theta_{JA}$$

where:

- $P_{DISS}$  is the power dissipated within the MLF package.  $\theta_{JA}$  is a combination of junction-to-case thermal resistance ( $\theta_{JC}$ ) and Case-to-Ambient thermal resistance ( $\theta_{CA}$ ), since thermal resistance of the solder connection from the EPAD to the PCB is negligible, so  $\theta_{JA} = \theta_{JC} + \theta_{CA}$ .
- $T_{AMB}$  is the operating ambient temperature.

### Thermal Measurements

Measuring the IC's case temperature is recommended to ensure it is within its operating limits. Although this might seem like a very elementary task, it is easy to get erroneous results. The most common mistake is to use the standard thermal couple that comes with a thermal meter. This thermal couple wire gauge is large, typically 22 gauge, and behaves like a heatsink, resulting in a lower case measurement.

Two methods of temperature measurement are using a smaller thermal couple wire or an infrared thermometer. If a thermal couple wire is used, it must be constructed of 36 gauge wire or higher then (smaller wire size) to minimize the wire heat-sinking effect. In addition, the thermal couple tip must be covered in either thermal grease or thermal glue to make sure that the thermal couple junction is making good contact with the case of the IC. Omega brand thermal couple (5SC-TT-K-36-36) is adequate for most applications.

Wherever possible, an infrared thermometer is recommended. The measurement spot size of most infrared thermometers is too large for an accurate reading on a small form factor ICs. However, an IR thermometer from Optris has a 1mm spot size, which makes it a good choice for measuring the hottest point on the case. An optional stand makes it easy to hold the beam on the IC for long periods of time.

## PCB Layout Guidelines

**Warning!!! To minimize EMI and output noise, follow these layout recommendations.**

PCB Layout is critical to achieve reliable, stable and efficient performance. A ground plane is required to control EMI and minimize the inductance in power, signal and return paths. Thickness of the copper planes is also important in terms of dissipating heat. The 2 ounce copper thickness is adequate from thermal point of view and also thick copper plain helps in terms of noise immunity. Keep in mind thinner planes can be easily penetrated by noise

The following guidelines should be followed to insure proper operation of the MIC23201 converter.

### IC

- Place the IC close to the point of load (POL).
- Use fat traces to route the input and output power lines.
- The signal ground pin (AGND) must be connected directly to the ground planes.
- Signal and power grounds should be kept separate and connected at only one location.

### Input Capacitor

- Place the input capacitor next to the power pins.
- Place the input capacitors on the same side of the board and as close to the IC as possible.
- Keep both the VIN pin and PGND connections short.
- Place several vias to the ground plane close to the input capacitor ground terminal.
- Use either X7R or X5R dielectric input capacitors. Do not use Y5V or Z5U type capacitors.
- Do not replace the ceramic input capacitor with any other type of capacitor. Any type of capacitor can be placed in parallel with the input capacitor.
- If a Tantalum input capacitor is placed in parallel with the input capacitor, it must be recommended for switching regulator applications and the operating voltage must be derated by 50%.
- In "Hot-Plug" applications, a Tantalum or Electrolytic bypass capacitor must be used to limit the over-voltage spike seen on the input supply with power is suddenly applied.

### Inductor

- Keep the inductor connection to the switch node (SW) short.
- Do not route any digital lines underneath or close to the inductor.
- Keep the switch node (SW) away from the feedback

(FB) pin.

- To minimize noise, place a ground plane underneath the inductor.
- The inductor can be placed on the opposite side of the PCB with respect to the IC. It does not matter whether the IC or inductor is on the top or bottom as long as there is enough air flow to keep the power components within their temperature limits. The input and output capacitors must be placed on the same side of the board as the IC.

### Output Capacitor

- Use a wide trace to connect the output capacitor ground terminal to the input capacitor ground terminal.
- Phase margin will change as the output capacitor value and ESR changes. Contact the factory if the output capacitor is different from what is shown in the BOM.
- The feedback trace should be separate from the power trace and connected as close as possible to the output capacitor. Sensing a long high current load trace can degrade the DC load regulation.

### RC Snubber

- Place the RC snubber on either side of the board and as close to the SW pin as possible.

**Typical Application Circuit**

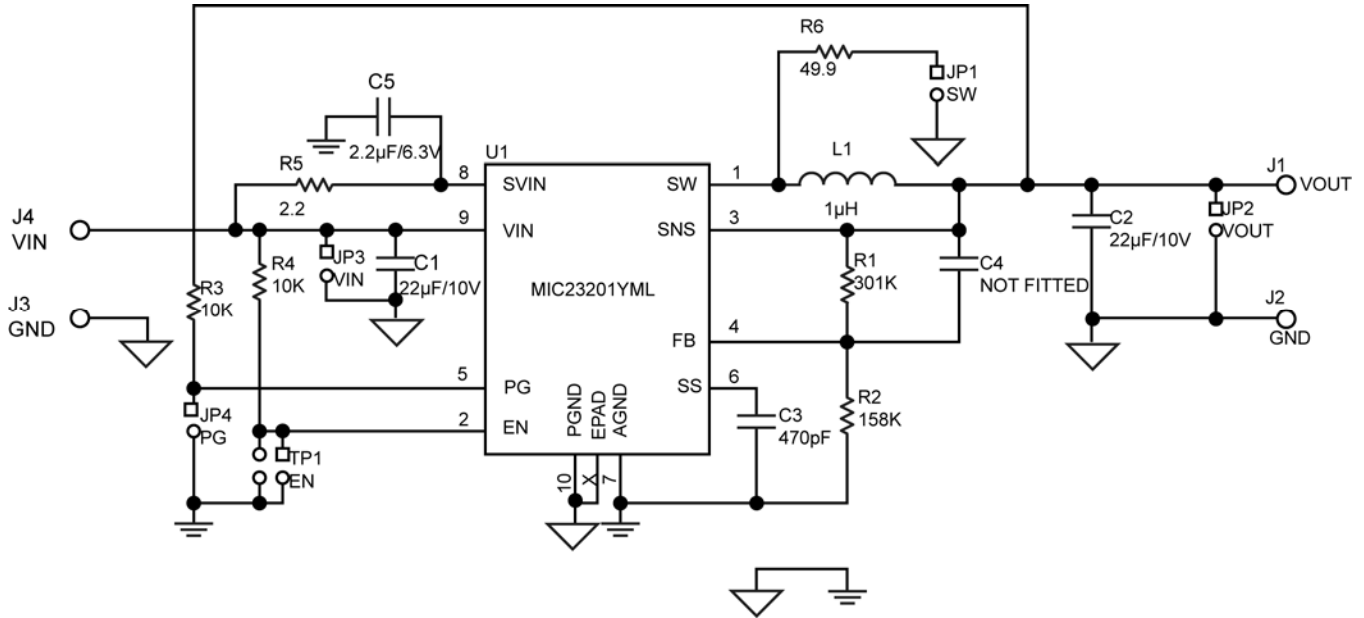

**Bill of Materials**

Item	Part Number	Manufacturer	Description	Qty.
C1, C2	GRM31CR71A226KE15L	Murata <sup>(1)</sup>	Ceramic Capacitor, 22µF, 10V, X7R, Size 1206	2
C3	06035C471KAT2A	AVX <sup>(2)</sup>	Ceramic Capacitor, 470pF, 50V, X7R, Size 0603	1
	GRM188R71H471KA01D	Murata		
	C1608X7R1H471K	TDK <sup>(3)</sup>		
C4	-	-	Not Fitted (NF)	
C5	06036D225KAT2A	AVX	Ceramic Capacitor, 2.2µ F, 6.3V, X5R, Size 0603	1
	GRM188R60J225KE19D	Murata		
	C1608X5R0J225K	TDK		
L1	VLS4012T-1R0N1R6	TDK	1µH, 2.5A, 60mΩ, L4.0mm x W4.0mm x H1.2mm	1
R1	CRCW0201301KFKED	Vishay/Dale <sup>(4)</sup>	Resistor, 301k Ω, Size 0603	1
R2	ERJ-1GEF1583C	Panasonic - ECG <sup>(5)</sup>	Resistor, 158k Ω, Size 0603	1
R3, R4	CRCW020110K0JNED	Vishay/Dale	Resistor, 10k Ω, Size 0603	2
R5	ERJ-3GEYJ2R2V	Panasonic - ECG	Resistor, 2.2 Ω, Size 0603	
R6	CRCW020149R9FKED	Vishay/Dale	Resistor, 49.9Ω, Size 0603	
U1	<b>MIC23201YML</b>	<b>Micrel, Inc.<sup>(6)</sup></b>	<b>2MHz 2A Buck Regulator with Hyper Speed Control Mode</b>	<b>1</b>

**Notes:**

1. Murata : [www.murata.com](http://www.murata.com).
2. AVX: [www.avx.com](http://www.avx.com).
3. TDK: [www.tdk.com](http://www.tdk.com).
4. Vishay: [www.vishay.com](http://www.vishay.com).
5. Panasonic: [www.industrial.panasonic.com](http://www.industrial.panasonic.com).
6. Micrel, Inc.: [www.micrel.com](http://www.micrel.com).



### PCB Layout

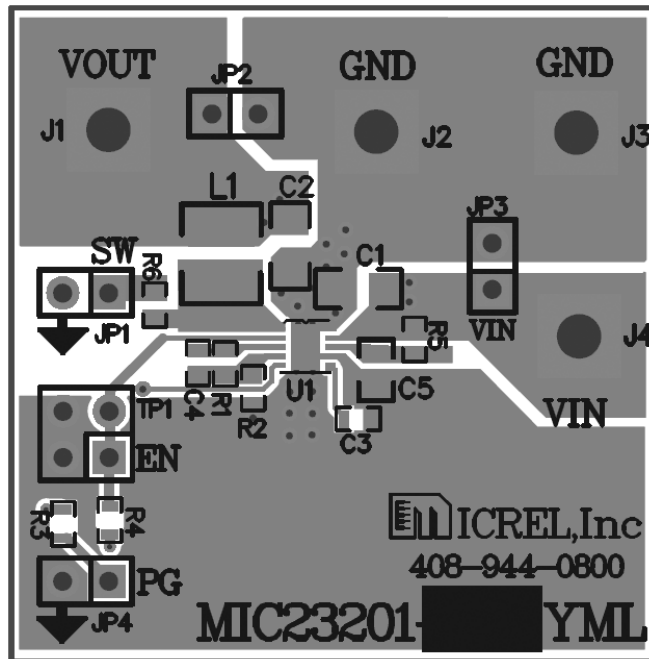

Figure 11. MIC23201 Evaluation Board Top Layer

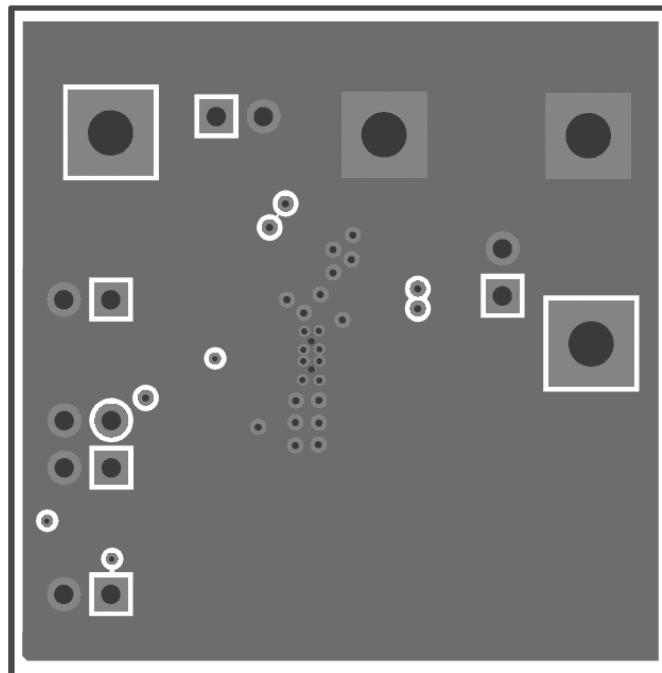

Figure 12. MIC23201 Evaluation Board Mid-Layer 1 (Ground Plane)

### PCB Layout (Continued)

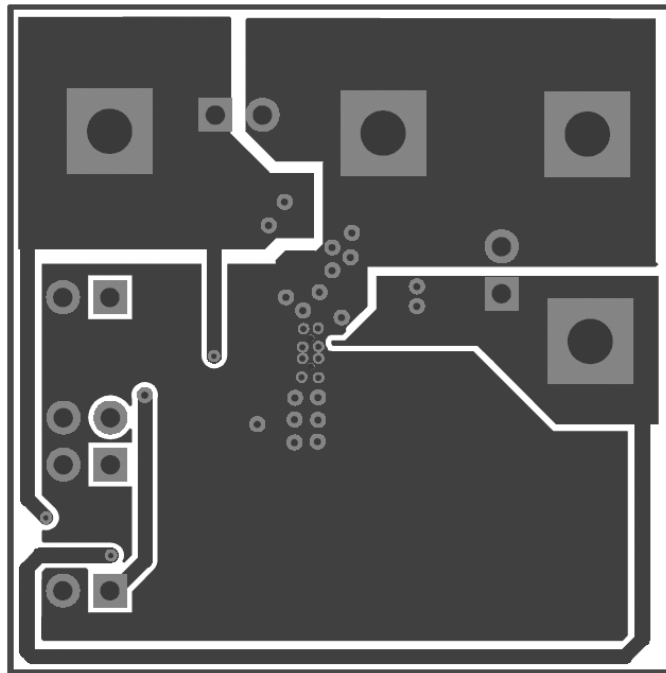

Figure 13. MIC23201 Evaluation Board Mid-Layer 2

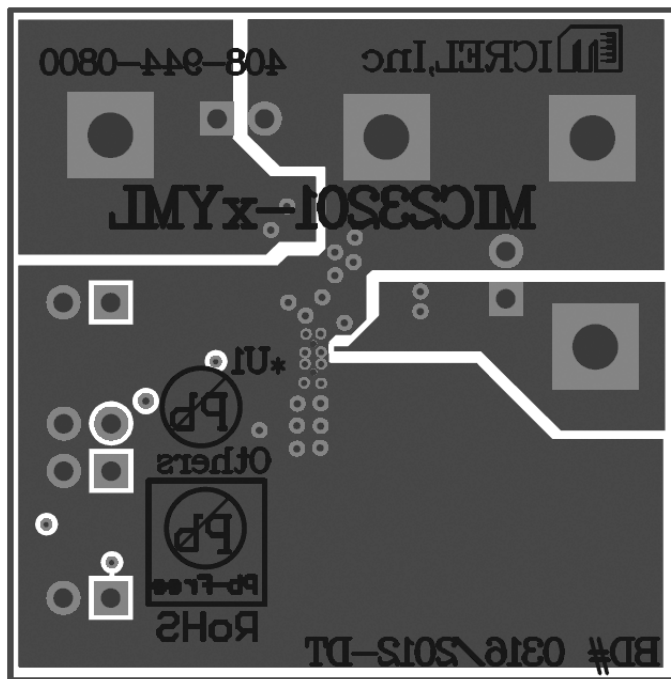
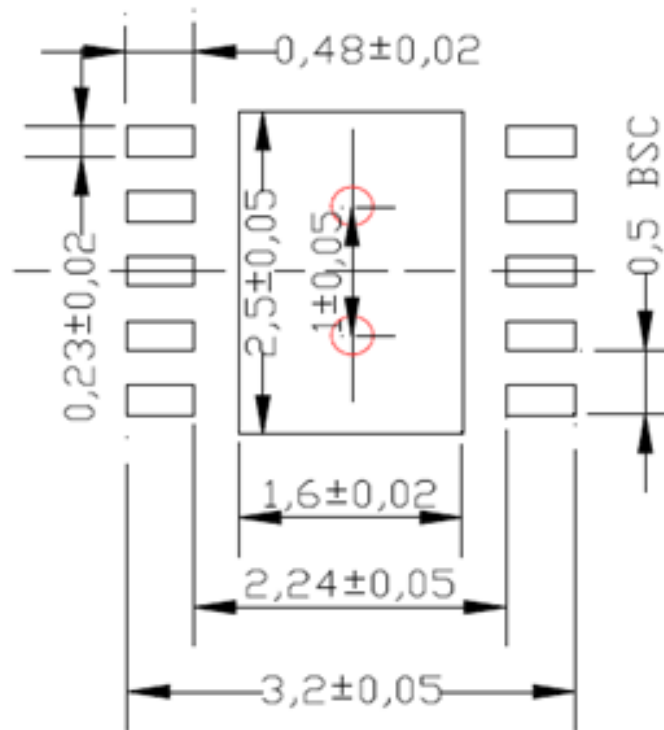

Figure 14. MIC23201 Evaluation Board Bottom Layer

### Recommended Land Pattern



**Red circle** indicates Thermal Via. Size should be .300-.350 mm in diameter and it should be connected to GND plane for maximum thermal performance.

ALL UNITS ARE IN mm, TOLERANCE  $\pm 0.05$ , IF NOT NOTED

LP # MLF33D-10LD-LP-1

**Package Information**

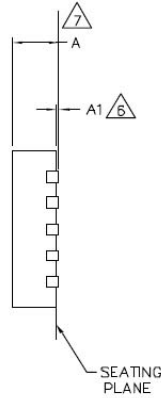
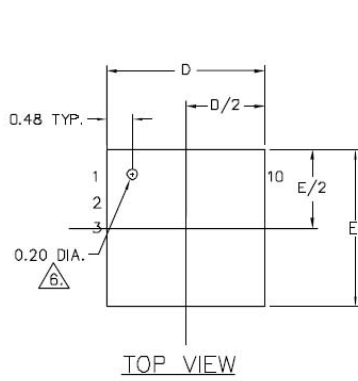

DIMENSION (mm)			
	MIN.	NOM.	MAX.
A	0.80	0.85	1.00
A1	0.00	0.01	0.05
D	3.00 BSC		
D2	1.45	1.60	1.75
E	3.00 BSC		
E2	2.15	2.30	2.45
e	0.50 BSC		
L	0.35	0.40	0.55
b	0.18	0.23	0.30

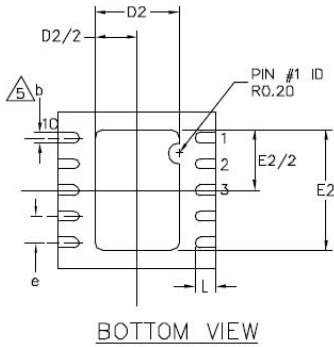

- NOTE:
1. ALL DIMENSIONS ARE IN MILLIMETERS.
  2. MAX. PACKAGE WARPAGE IS 0.05 mm.
  3. MAXIMUM ALLOWABLE BURRS IS 0.076 mm IN ALL DIRECTIONS.
  4. PIN #1 ID ON TOP WILL BE LASER/INK MARKED.
- △ DIMENSION 10 APPLIES TO METALIZED TERMINAL AND IS MEASURED BETWEEN 0.20 AND 0.25 mm FROM TERMINAL TIP.
- △ APPLIED ONLY FOR TERMINALS.
- △ APPLIED FOR EXPOSED PAD AND TERMINALS.



MLF33D-10LD-PD-1

**10-Pin 3mm x 3mm MLF (ML)**

**MICREL, INC. 2180 FORTUNE DRIVE SAN JOSE, CA 95131 USA**  
 TEL +1 (408) 944-0800 FAX +1 (408) 474-1000 WEB <http://www.micrel.com>

The information furnished by Micrel in this data sheet is believed to be accurate and reliable. However, no responsibility is assumed by Micrel for its use. Micrel reserves the right to change circuitry and specifications at any time without notification to the customer.

Micrel Products are not designed or authorized for use as components in life support appliances, devices or systems where malfunction of a product can reasonably be expected to result in personal injury. Life support devices or systems are devices or systems that (a) are intended for surgical implant into the body or (b) support or sustain life, and whose failure to perform can be reasonably expected to result in a significant injury to the user. A Purchaser's use or sale of Micrel Products for use in life support appliances, devices or systems is a Purchaser's own risk and Purchaser agrees to fully indemnify Micrel for any damages resulting from such use or sale.

© 2012 Micrel, Incorporated.

# Mouser Electronics

Authorized Distributor

Click to View Pricing, Inventory, Delivery & Lifecycle Information:

[Micrel:](#)

[MIC23201YML T5](#) [MIC23201YML-TR](#) [MIC23201YML-T5](#)