

PRODUCT NO. DSHP10TSGE1
RoHS compliant

NOTES :1.Specification:

- 1>.Operating force:1000gf Max
- 2>.Operating Temperature: -40° to+85°
- 3>.Storage Temperature: -40° to+85°
- 4>.Electrical Life:1000cycles 25mA 24VDC
- 5>.Mechanical Life:3000cycles Operations

2. PLATING:
GOLD FLASH 1u"(min.) SOLDER TAIL,
3u" GOLD PLATING ON THE CONTACT AREA,
WITH 50u" NICKEL UNDERPLATINGOVERALL.
3. PART NUMBER DESCRIPTION :

DSHP XX I S G E I

【包装方式: T=管装 R=Reel】

【电鍍层: B=鍍鍍3u"厚脚部1.2u"G=鍍鍍3u"厚脚部3u" F=鍍鍍10u"厚脚部10u"】

【G=鍍全金 S=内鍍金(接触部)外鍍锡(焊脚部)】

【脚型: S脚 / J脚 / I脚 / A脚 / Z脚】

【T=低推贴胶 S=低推不贴胶 L=长推】

【产品P数: 02=2P 04=4P 06=6P 08=8P 10=10P 12=12P】

[Schematic]

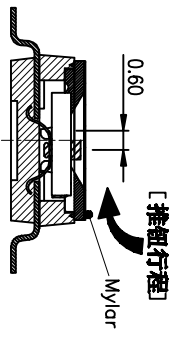
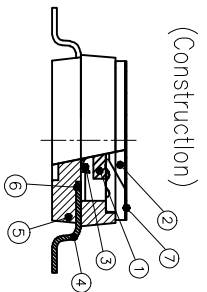
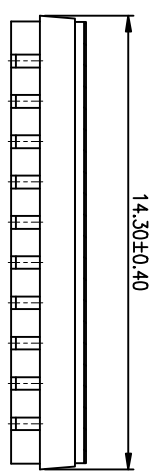
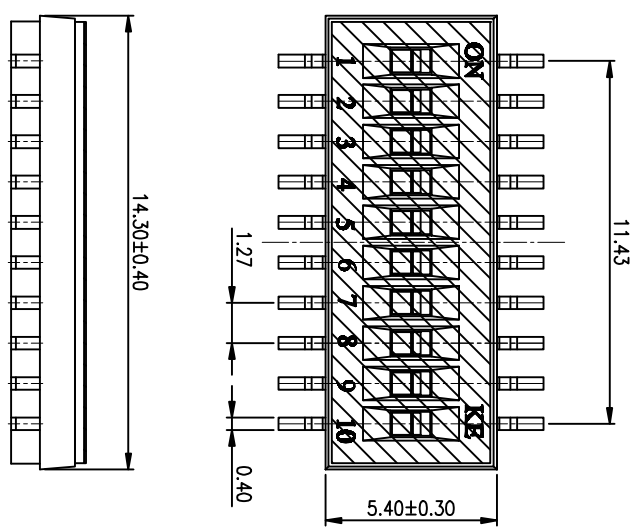
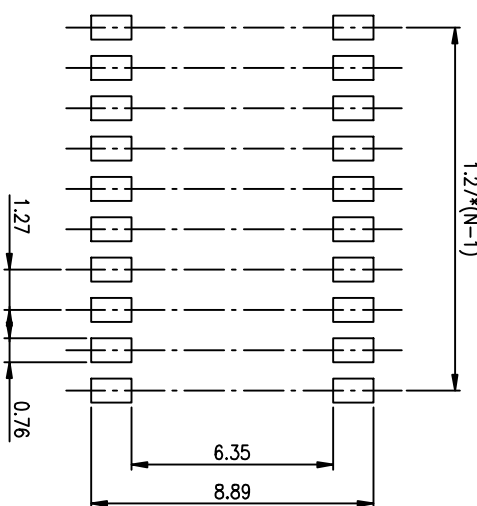
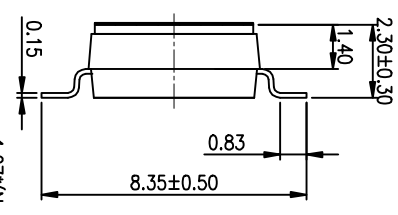
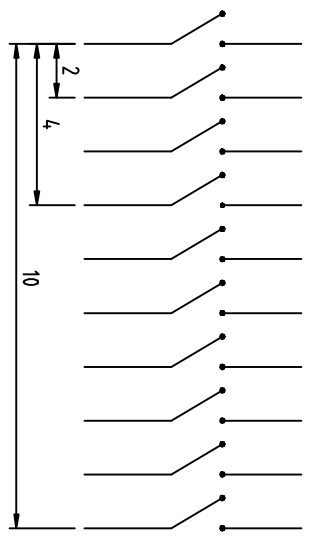

Number	Part Name	Material	Finished
①	Actuator	UL94 V0	White
②	Cover	UL94 V0	Black
③	Movable	Beryllium Copper	3u" Gold
④	Terminal	Brass	1u" Gold
⑤	Base	UL94 V0	Black
⑥	Terminal Contact	Brass	3u" Gold
⑦	Mylar	UL94 V0	0.05mm

TOLERANCE UNLESS OTHERWISE SPECIFIED		INSPECTION COPY	
LINER	ANGLES	PROJECTION	
0 ± 0.25	0 ± 2'		
.00 ± 0.15	.0 ± 1'		
.000± 0.10	.00± 0.5'		
DESIGN	kathy	03/20/12	
DRAWING			
CHECK			
APPRO.			

東莞精密電子股份有限公司
Dongguan Kingtek Industrial Co., Ltd.

TITLE
BY DSHP SERIES PITCH 1.27mm

PRODUCT FAMILY DSHP SERIES
PRAT NO. DSHP10TSGE1

FILE NO. DSHP10TSGE1-A
SIZE UNIT SCALE SHEET REV.
A4 mm Z : 1 1OF 1 A