

AD8661/AD8662/AD8664

FEATURES

Low offset voltage: 100 μ V maximum @ $V_S = 5$ V

Low input bias current: 1 pA maximum

Single-supply operation: 5 V to 16 V

Low noise: 10 nV/ $\sqrt{\text{Hz}}$

Wide bandwidth: 4 MHz

Unity-gain stable

Small package options

3 mm \times 3 mm 8-lead LFCSP

8-lead MSOP and narrow SOIC

14-lead TSSOP and narrow SOIC

APPLICATIONS

Sensors

Medical equipment

Consumer audio

Photodiode amplification

ADC drivers

PIN CONFIGURATIONS

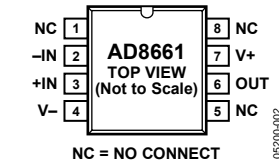

Figure 1. AD8661, 8-Lead SOIC_N (R-8)

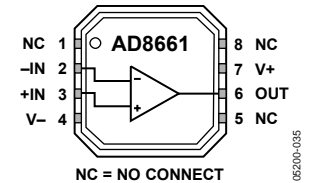

Figure 2. AD8661, 8-Lead LFCSP_VD (CP-8-2)

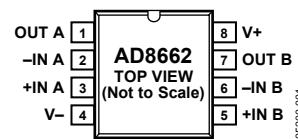

Figure 3. AD8662, 8-Lead SOIC_N (R-8)



Figure 4. AD8662, 8-Lead MSOP (RM-8)

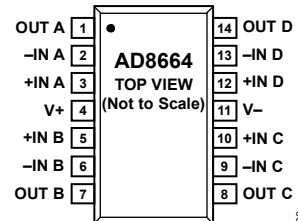

Figure 5. AD8664, 14-Lead SOIC_N (R-14)

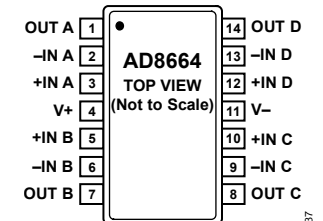

Figure 6. AD8664, 14-Lead TSSOP (RU-14)

GENERAL DESCRIPTION

The AD8661/AD8662/AD8664 are rail-to-rail output, single-supply amplifiers that use the Analog Devices, Inc., patented DigiTrim[®] trimming technique to achieve low offset voltage. The AD866x series features extended operating ranges, with supply voltages up to 16 V. It also features low input bias current, wide signal bandwidth, and low input voltage and current noise.

The combination of low offset, very low input bias current, and a wide supply range makes these amplifiers useful in a wide variety of applications usually associated with higher priced JFET amplifiers. Systems using high impedance sensors, such as photodiodes, benefit from the combination of low input bias current, low noise, low offset, and wide bandwidth. The wide operating voltage range meets the demands of high performance ADCs and DACs. Audio applications and medical

monitoring equipment can take advantage of the high input impedance, low voltage and current noise, and wide bandwidth.

The single AD8661 is available in a narrow 8-lead SOIC package and a very thin, dual lead, 8-lead LFCSP. The AD8661 SOIC_N package is specified over the extended industrial temperature range of -40°C to $+125^{\circ}\text{C}$. The AD8661 LFCSP_VD is specified over the industrial temperature range of -40°C to $+85^{\circ}\text{C}$. The AD8662 is available in a narrow 8-lead SOIC package and an 8-lead MSOP, both specified over the extended industrial temperature range of -40°C to $+125^{\circ}\text{C}$. The AD8664 is available in a narrow 14-lead SOIC package and a 14-lead TSSOP, both with an extended industrial temperature range of -40°C to $+125^{\circ}\text{C}$.

Rev. D

Information furnished by Analog Devices is believed to be accurate and reliable. However, no responsibility is assumed by Analog Devices for its use, nor for any infringements of patents or other rights of third parties that may result from its use. Specifications subject to change without notice. No license is granted by implication or otherwise under any patent or patent rights of Analog Devices. Trademarks and registered trademarks are the property of their respective owners.

TABLE OF CONTENTS

Features	1	AD8661 Electrical Characteristics—LFCSP_VD Only.....	5
Applications.....	1	AD8661 Electrical Characteristics—LFCSP_VD Only.....	6
Pin Configurations	1	Absolute Maximum Ratings	7
General Description	1	Thermal Resistance	7
Revision History	2	ESD Caution.....	7
Specifications.....	3	Typical Performance Characteristics	8
AD8661/AD8662/AD8664 Electrical Characteristics—		Outline Dimensions	13
SOIC_N, MSOP, and TSSOP	3	Ordering Guide	15
AD8661/AD8662/AD8664 Electrical Characteristics—			
SOIC_N, MSOP, and TSSOP	4		

REVISION HISTORY

7/06—Rev. C to Rev. D

Added AD8664	Universal
Added 14-Lead SOIC_N and 14-Lead TSSOP	Universal
Changes to Features.....	1
Changes to Table 1	3
Changes to Table 2.....	4
Changes to Table 3.....	5
Changes to Table 4.....	6
Changes to Table 5 and Table 6.....	7
Changes to Figure 29.....	11
Updated Outline Dimensions	13
Changes to Ordering Guide	15

5/06—Rev. B to Rev. C

Changes to Ordering Guide	13
---------------------------------	----

3/06—Rev. A to Rev. B

Added AD8662	Universal
Added MSOP	Universal

Changes to Table 1	3
Changes to Table 2.....	4
Changes to Table 3.....	5
Changes to Table 4.....	6
Changes to Table 5.....	7
Updated Outline Dimensions	13
Changes to Ordering Guide	13

1/06—Rev. 0 to Rev. A

Added LFCSP_VD	Universal
Changes to Table 1.....	3
Changes to Table 2.....	4
Changes to Ordering Guide	13

9/05—Revision 0: Initial Version

SPECIFICATIONS

AD8661/AD8662/AD8664 ELECTRICAL CHARACTERISTICS—SOIC_N, MSOP, AND TSSOP

$V_S = 5.0\text{ V}$, $V_{CM} = V_S/2$, $T_A = 25^\circ\text{C}$, unless otherwise noted.

Table 1.

Parameter	Symbol	Conditions	Min	Typ	Max	Unit
INPUT CHARACTERISTICS						
Offset Voltage	V_{OS}	$V_{CM} = V_S/2$		30	100	μV
AD8661		$-40^\circ\text{C} < T_A < +85^\circ\text{C}$			1000	μV
AD8661		$-40^\circ\text{C} < T_A < +125^\circ\text{C}$			1400	μV
AD8662		$-40^\circ\text{C} < T_A < +125^\circ\text{C}$			1000	μV
AD8664		$-40^\circ\text{C} < T_A < +125^\circ\text{C}$			1200	μV
Input Bias Current	I_B			0.3	1	pA
		$-40^\circ\text{C} < T_A < +85^\circ\text{C}$			50	pA
		$-40^\circ\text{C} < T_A < +125^\circ\text{C}$			300	pA
Input Offset Current	I_{OS}			0.2	0.5	pA
		$-40^\circ\text{C} < T_A < +85^\circ\text{C}$			20	pA
		$-40^\circ\text{C} < T_A < +125^\circ\text{C}$			75	pA
Input Voltage Range			-0.1		+3.0	V
Common-Mode Rejection Ratio	CMRR	$V_{CM} = -0.1\text{ V to }+3.0\text{ V}$	85	100		dB
		$-40^\circ\text{C} < T_A < +125^\circ\text{C}$	80	100		dB
Large Signal Voltage Gain	A_{VO}	$R_L = 2\text{ k}\Omega$, $V_O = 0.5\text{ V to }4.5\text{ V}$	100	220		V/mV
Offset Voltage Drift	TCV_{OS}					
AD8661		$-40^\circ\text{C} < T_A < +125^\circ\text{C}$		3	10	$\mu\text{V}/^\circ\text{C}$
AD8662, AD8664		$-40^\circ\text{C} < T_A < +125^\circ\text{C}$		2	9	$\mu\text{V}/^\circ\text{C}$
OUTPUT CHARACTERISTICS						
Output Voltage High	V_{OH}	$I_L = 1\text{ mA}$	4.85	4.93		V
		$-40^\circ\text{C} < T_A < +125^\circ\text{C}$	4.80			V
Output Voltage Low	V_{OL}	$I_L = 1\text{ mA}$		50	100	mV
		$-40^\circ\text{C} < T_A < +125^\circ\text{C}$			110	mV
Short-Circuit Current	I_{SC}			± 19		mA
Closed-Loop Output Impedance	Z_{OUT}	$f = 1\text{ MHz}$, $A_V = 1$		50		Ω
POWER SUPPLY						
Supply Current per Amplifier	I_{SY}	$V_O = V_S/2$		1.15	1.40	mA
		$-40^\circ\text{C} < T_A < +125^\circ\text{C}$			2.0	mA
DYNAMIC PERFORMANCE						
Slew Rate	SR	$R_L = 2\text{ k}\Omega$		3.5		$\text{V}/\mu\text{s}$
Gain Bandwidth Product	GBP			4		MHz
Phase Margin	Φ_O			65		Degrees
NOISE PERFORMANCE						
Peak-to-Peak Noise	$e_n\text{ p-p}$	$f = 0.1\text{ Hz to }10\text{ Hz}$		2.5		$\mu\text{V p-p}$
Voltage Noise Density	e_n	$f = 1\text{ kHz}$		12		$\text{nV}/\sqrt{\text{Hz}}$
		$f = 10\text{ kHz}$		10		$\text{nV}/\sqrt{\text{Hz}}$
Current Noise Density	i_n	$f = 1\text{ kHz}$		0.1		$\text{pA}/\sqrt{\text{Hz}}$

AD8661/AD8662/AD8664

AD8661/AD8662/AD8664 ELECTRICAL CHARACTERISTICS—SOIC_N, MSOP, AND TSSOP

$V_S = 16.0\text{ V}$, $V_{CM} = V_S/2$, $T_A = 25^\circ\text{C}$, unless otherwise noted.

Table 2.

Parameter	Symbol	Conditions	Min	Typ	Max	Unit
INPUT CHARACTERISTICS						
Offset Voltage	V_{OS}	$V_{CM} = V_S/2$		50	160	μV
AD8661		$-40^\circ\text{C} < T_A < +85^\circ\text{C}$			1000	μV
AD8661		$-40^\circ\text{C} < T_A < +125^\circ\text{C}$			1400	μV
AD8662		$-40^\circ\text{C} < T_A < +125^\circ\text{C}$			1000	μV
AD8664		$-40^\circ\text{C} < T_A < +125^\circ\text{C}$			1200	μV
Input Bias Current	I_B			0.3	1	pA
		$-40^\circ\text{C} < T_A < +85^\circ\text{C}$			50	pA
		$-40^\circ\text{C} < T_A < +125^\circ\text{C}$			300	pA
Input Offset Current	I_{OS}			0.2	0.5	pA
		$-40^\circ\text{C} < T_A < +85^\circ\text{C}$			20	pA
		$-40^\circ\text{C} < T_A < +125^\circ\text{C}$			75	pA
Input Voltage Range			-0.1		+14.0	V
Common-Mode Rejection Ratio	CMRR	$V_{CM} = -0.1\text{ V to }+14.0\text{ V}$	90	110		dB
		$-40^\circ\text{C} < T_A < +125^\circ\text{C}$	90	110		dB
Large Signal Voltage Gain	A_{VO}	$R_L = 2\text{ k}\Omega$, $V_O = 0.5\text{ V to }15.5\text{ V}$	200	360		V/mV
Offset Voltage Drift	TCV_{OS}					$\mu\text{V}/^\circ\text{C}$
AD8661		$-40^\circ\text{C} < T_A < +125^\circ\text{C}$		3	10	$\mu\text{V}/^\circ\text{C}$
AD8662, AD8664		$-40^\circ\text{C} < T_A < +125^\circ\text{C}$		2	9	$\mu\text{V}/^\circ\text{C}$
OUTPUT CHARACTERISTICS						
Output Voltage High	V_{OH}	$I_L = 1\text{ mA}$	15.93	15.97		V
		$I_L = 10\text{ mA}$	15.60	15.70		V
		$-40^\circ\text{C} < T_A < +125^\circ\text{C}$	15.50			V
Output Voltage Low	V_{OL}	$I_L = 1\text{ mA}$		24	50	mV
		$I_L = 10\text{ mA}$		190	300	mV
		$-40^\circ\text{C} < T_A < +125^\circ\text{C}$			350	mV
Short-Circuit Current	I_{SC}			± 140		mA
Closed-Loop Output Impedance	Z_{OUT}	$f = 1\text{ MHz}$, $A_V = 1$		45		Ω
POWER SUPPLY						
Power Supply Rejection Ratio	PSRR	$V_S = 5\text{ V to }16\text{ V}$	95	110		dB
		$-40^\circ\text{C} < T_A < +125^\circ\text{C}$	95	115		dB
Supply Current per Amplifier	I_{SY}	$V_O = V_S/2$		1.25	1.55	mA
		$-40^\circ\text{C} < T_A < +125^\circ\text{C}$			2.1	mA
DYNAMIC PERFORMANCE						
Slew Rate	SR	$R_L = 2\text{ k}\Omega$		3.5		V/ μs
Gain Bandwidth Product	GBP			4		MHz
Phase Margin	Φ_O			65		Degrees
NOISE PERFORMANCE						
Peak-to-Peak Noise	$e_n\text{ p-p}$	$f = 0.1\text{ Hz to }10\text{ Hz}$		2.5		$\mu\text{V p-p}$
Voltage Noise Density	e_n	$f = 1\text{ kHz}$		12		$\text{nV}/\sqrt{\text{Hz}}$
		$f = 10\text{ kHz}$		10		$\text{nV}/\sqrt{\text{Hz}}$
Current Noise Density	i_n	$f = 1\text{ kHz}$		0.1		$\text{pA}/\sqrt{\text{Hz}}$

AD8661 ELECTRICAL CHARACTERISTICS—LFCSP_VD ONLY

$V_S = 5.0\text{ V}$, $V_{CM} = V_S/2$, $T_A = 25^\circ\text{C}$, unless otherwise noted.

Table 3.

Parameter	Symbol	Conditions	Min	Typ	Max	Unit
INPUT CHARACTERISTICS						
Offset Voltage	V_{OS}	$V_{CM} = V_S/2$ $-40^\circ\text{C} < T_A < +85^\circ\text{C}$		50	300	μV
Input Bias Current	I_B	$-40^\circ\text{C} < T_A < +85^\circ\text{C}$		0.3	1	μV
Input Offset Current	I_{OS}	$-40^\circ\text{C} < T_A < +85^\circ\text{C}$			50	μV
Input Voltage Range		$-40^\circ\text{C} < T_A < +85^\circ\text{C}$		0.2	0.5	μV
Common-Mode Rejection Ratio	CMRR	$V_{CM} = -0.1\text{ V to }+3.0\text{ V}$ $-40^\circ\text{C} < T_A < +85^\circ\text{C}$	-0.1	85	100	dB
Large Signal Voltage Gain	A_{VO}	$R_L = 2\text{ k}\Omega$, $V_O = 0.5\text{ V to }4.5\text{ V}$	80	100		dB
Offset Voltage Drift	TCV_{OS}	$-40^\circ\text{C} < T_A < +85^\circ\text{C}$	100	240		V/mV
OUTPUT CHARACTERISTICS						
Output Voltage High	V_{OH}	$I_L = 1\text{ mA}$ $-40^\circ\text{C} < T_A < +85^\circ\text{C}$	4.85	4.93		V
Output Voltage Low	V_{OL}	$I_L = 1\text{ mA}$ $-40^\circ\text{C} < T_A < +85^\circ\text{C}$	4.80	50	100	mV
Short-Circuit Current	I_{SC}			± 19	120	mV
Closed-Loop Output Impedance	Z_{OUT}	$f = 1\text{ MHz}$, $A_V = 1$		65		Ω
POWER SUPPLY						
Supply Current per Amplifier	I_{SY}	$V_O = V_S/2$ $-40^\circ\text{C} < T_A < +85^\circ\text{C}$		1.15	1.40	mA
DYNAMIC PERFORMANCE						
Slew Rate	SR	$R_L = 2\text{ k}\Omega$		3.5		$\text{V}/\mu\text{s}$
Gain Bandwidth Product	GBP			4		MHz
Phase Margin	Φ_O			65		Degrees
NOISE PERFORMANCE						
Peak-to-Peak Noise	e_n p-p	$f = 0.1\text{ Hz to }10\text{ Hz}$		2.5		$\mu\text{V p-p}$
Voltage Noise Density	e_n	$f = 1\text{ kHz}$		12		$\text{nV}/\sqrt{\text{Hz}}$
		$f = 10\text{ kHz}$		10		$\text{nV}/\sqrt{\text{Hz}}$
Current Noise Density	i_n	$f = 1\text{ kHz}$		0.1		$\text{pA}/\sqrt{\text{Hz}}$

AD8661/AD8662/AD8664

AD8661 ELECTRICAL CHARACTERISTICS—LFCSP_VD ONLY

$V_S = 16.0\text{ V}$, $V_{CM} = V_S/2$, $T_A = 25^\circ\text{C}$, unless otherwise noted.

Table 4.

Parameter	Symbol	Conditions	Min	Typ	Max	Unit
INPUT CHARACTERISTICS						
Offset Voltage	V_{OS}	$V_{CM} = V_S/2$ $-40^\circ\text{C} < T_A < +85^\circ\text{C}$		50	300	μV
Input Bias Current	I_B	$-40^\circ\text{C} < T_A < +85^\circ\text{C}$		0.3	1	μA
Input Offset Current	I_{OS}	$-40^\circ\text{C} < T_A < +85^\circ\text{C}$		0.2	0.5	μA
Input Voltage Range			-0.1		+14.0	V
Common-Mode Rejection Ratio	CMRR	$V_{CM} = -0.1\text{ V to }+14.0\text{ V}$ $-40^\circ\text{C} < T_A < +85^\circ\text{C}$	90	110		dB
Large Signal Voltage Gain	A_{VO}	$R_L = 2\text{ k}\Omega$, $V_O = 0.5\text{ V to }15.5\text{ V}$	200	420		V/mV
Offset Voltage Drift	TCV_{OS}	$-40^\circ\text{C} < T_A < +85^\circ\text{C}$		4	17	$\mu\text{V}/^\circ\text{C}$
OUTPUT CHARACTERISTICS						
Output Voltage High	V_{OH}	$I_L = 1\text{ mA}$ $I_L = 10\text{ mA}$ $-40^\circ\text{C} < T_A < +85^\circ\text{C}$	15.95 15.60 15.50	15.97 15.70		V V V
Output Voltage Low	V_{OL}	$I_L = 1\text{ mA}$ $I_L = 10\text{ mA}$ $-40^\circ\text{C} < T_A < +85^\circ\text{C}$		24 210	50 350	mV mV mV
Short-Circuit Current	I_{SC}			± 140		mA
Closed-Loop Output Impedance	Z_{OUT}	$f = 1\text{ MHz}$, $A_V = 1$		45		Ω
POWER SUPPLY						
Power Supply Rejection Ratio	PSRR	$V_S = 5\text{ V to }16\text{ V}$ $-40^\circ\text{C} < T_A < +85^\circ\text{C}$	95 95	110 115		dB dB
Supply Current per Amplifier	I_{SY}	$V_O = V_S/2$ $-40^\circ\text{C} < T_A < +85^\circ\text{C}$		1.25	1.55 1.9	mA mA
DYNAMIC PERFORMANCE						
Slew Rate	SR	$R_L = 2\text{ k}\Omega$		3.5		V/ μs
Gain Bandwidth Product	GBP			4		MHz
Phase Margin	Φ_O			65		Degrees
NOISE PERFORMANCE						
Peak-to-Peak Noise	$e_n\text{ p-p}$	$f = 0.1\text{ Hz to }10\text{ Hz}$		2.5		$\mu\text{V p-p}$
Voltage Noise Density	e_n	$f = 1\text{ kHz}$ $f = 10\text{ kHz}$		12 10		$\text{nV}/\sqrt{\text{Hz}}$ $\text{nV}/\sqrt{\text{Hz}}$
Current Noise Density	i_n	$f = 1\text{ kHz}$		0.1		$\text{pA}/\sqrt{\text{Hz}}$

ABSOLUTE MAXIMUM RATINGS

Table 5.

Parameter	Rating
Supply Voltage	18 V
Input Voltage	-0.1 V to V_S
Differential Input Voltage	18 V
Output Short-Circuit Duration to GND	Indefinite
Storage Temperature Range	-60°C to +150°C
Operating Temperature Range	
R-8, RM-8, R-14, and RU-14	-40°C to +125°C
CP-8-2	-40°C to +85°C
Junction Temperature Range	-65°C to +150°C
Lead Temperature, Soldering (60 sec)	300°C

Stresses above those listed under Absolute Maximum Ratings may cause permanent damage to the device. This is a stress rating only; functional operation of the device at these or any other conditions above those indicated in the operational section of this specification is not implied. Exposure to absolute maximum rating conditions for extended periods may affect device reliability.

ESD CAUTION

ESD (electrostatic discharge) sensitive device. Electrostatic charges as high as 4000 V readily accumulate on the human body and test equipment and can discharge without detection. Although this product features proprietary ESD protection circuitry, permanent damage may occur on devices subjected to high energy electrostatic discharges. Therefore, proper ESD precautions are recommended to avoid performance degradation or loss of functionality.



THERMAL RESISTANCE

θ_{JA} is specified for the worst-case conditions, that is, a device soldered in a circuit board for surface-mount packages.

Table 6. Thermal Resistance

Package Type	θ_{JA}	θ_{JC}	Unit
8-Lead SOIC_N	121	43	°C/W
8-Lead LFCSP_VD	75 ¹	18 ¹	°C/W
8-Lead MSOP	142	44	°C/W
14-Lead SOIC_N	88.2	56.3	°C/W
14-Lead TSSOP	114	23.3	°C/W

¹ Exposed pad soldered to application board.

TYPICAL PERFORMANCE CHARACTERISTICS

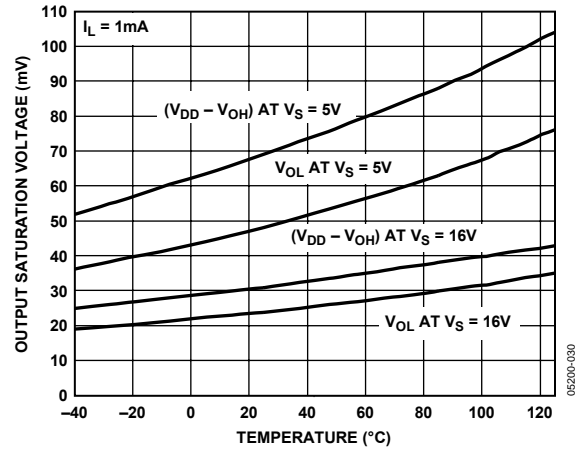
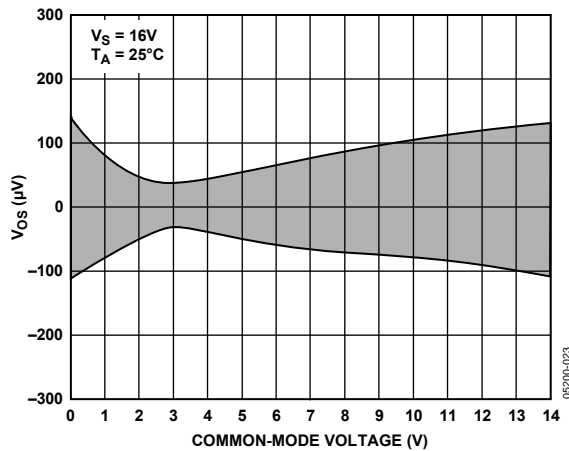
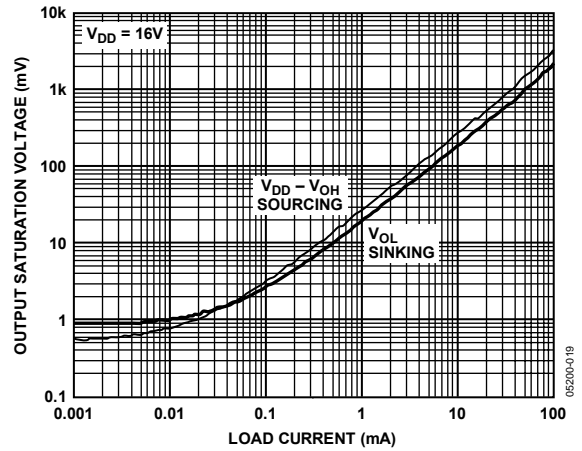
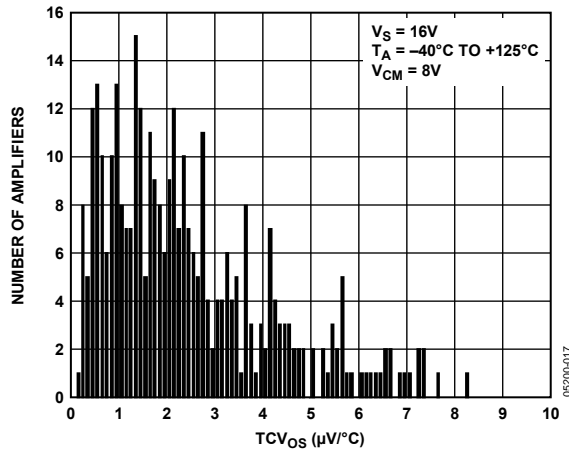
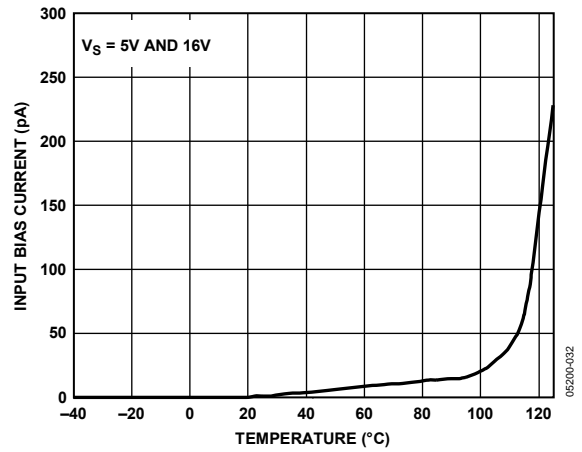
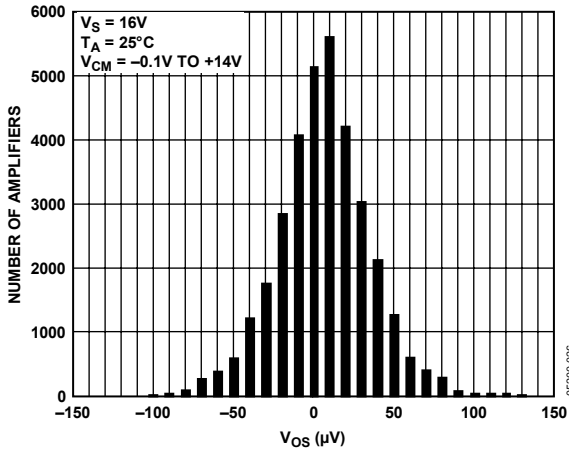

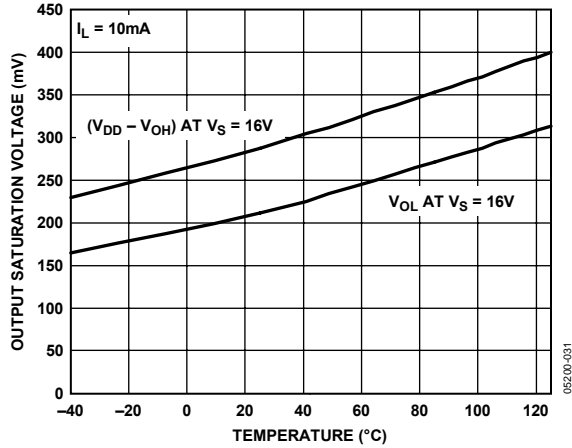

Figure 13. Output Swing Saturation Voltage vs. Temperature, $I_L = 10\text{ mA}$

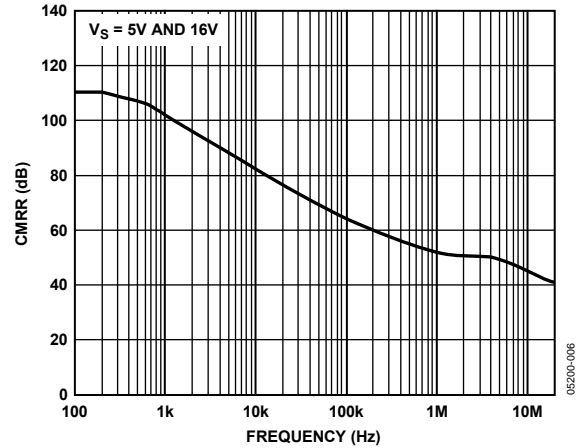

Figure 16. CMRR vs. Frequency

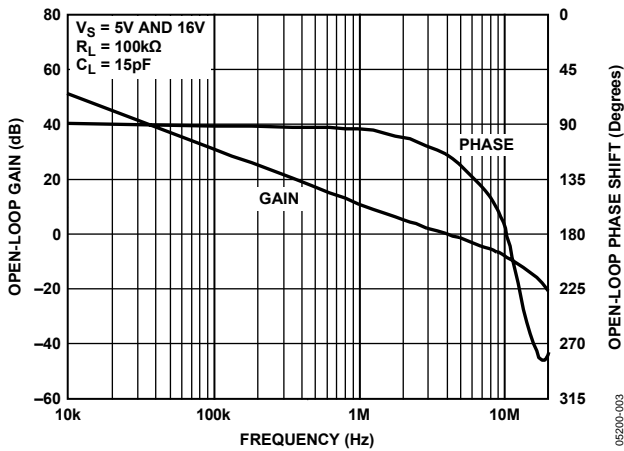

Figure 14. Open-Loop Gain and Phase Shift vs. Frequency

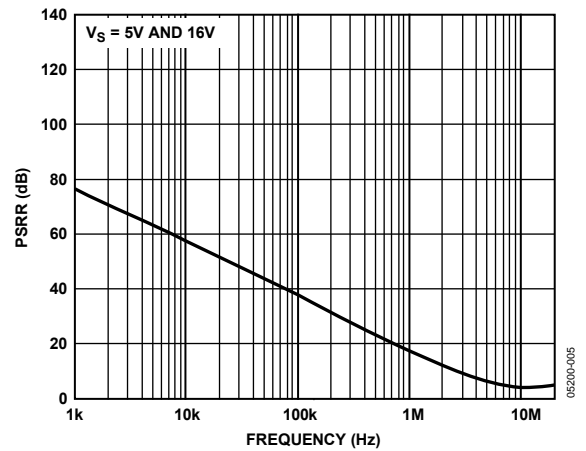

Figure 17. PSRR vs. Frequency

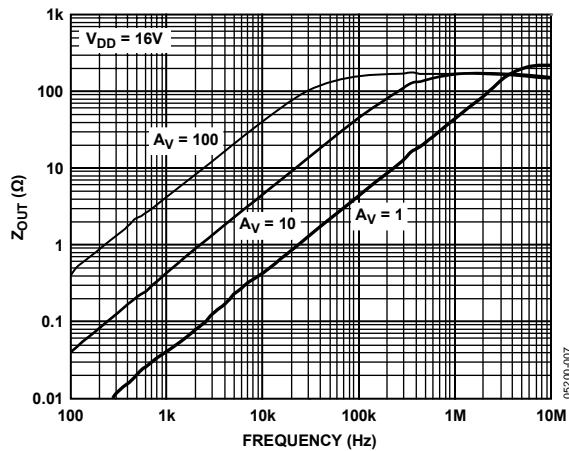

Figure 15. Closed-Loop Output Impedance vs. Frequency

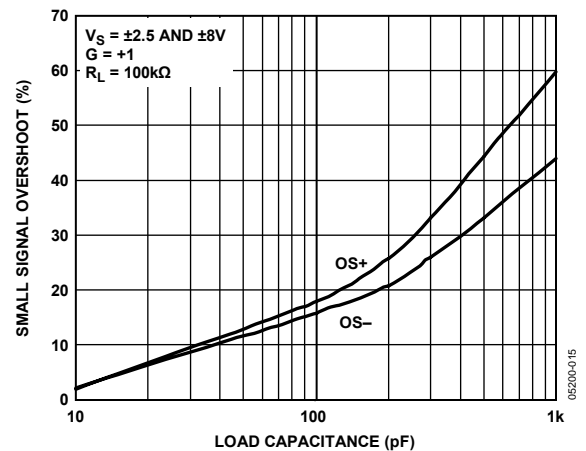

Figure 18. Small Signal Overshoot vs. Load Capacitance

AD8661/AD8662/AD8664

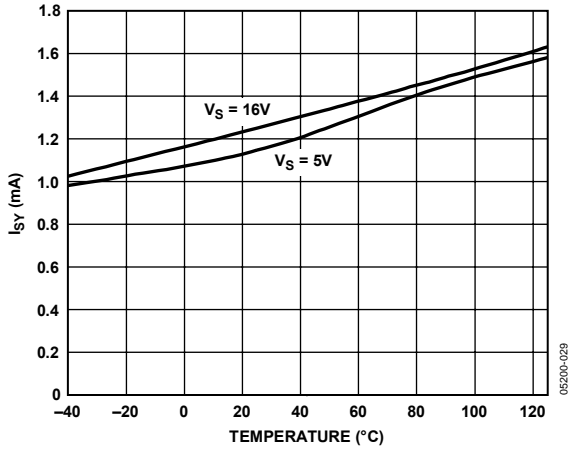

Figure 19. Supply Current vs. Temperature

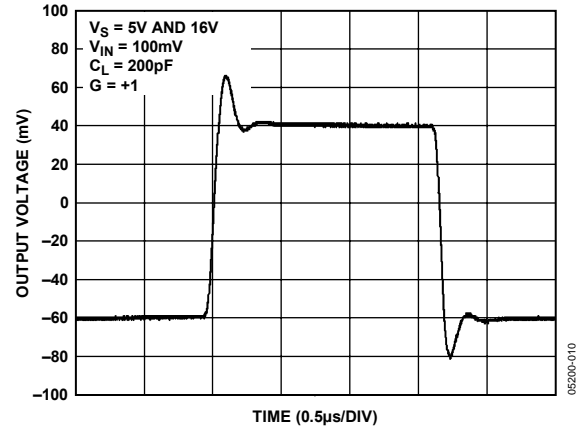

Figure 22. Small Signal Transient Response

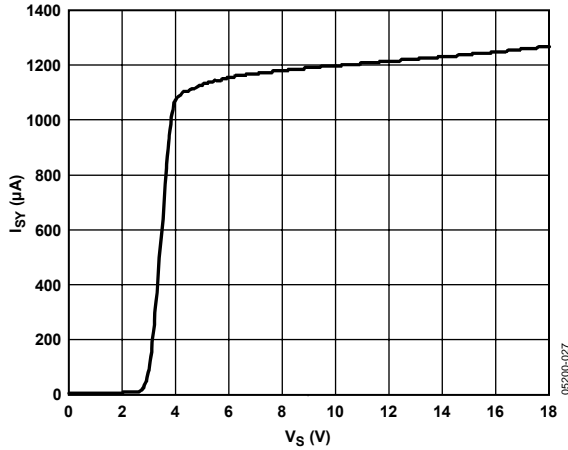

Figure 20. Supply Current vs. Supply Voltage (Dual-Supply Configuration), $T_A = 25^\circ\text{C}$

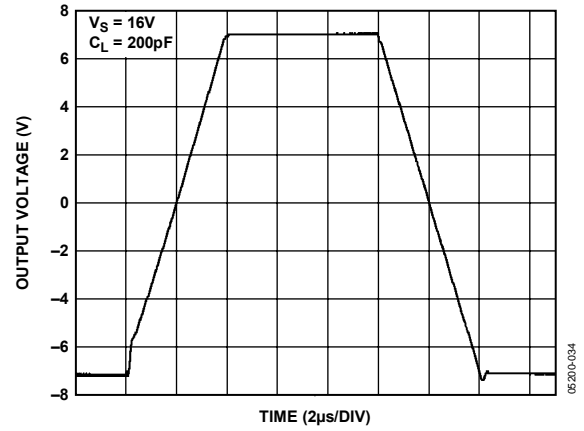

Figure 23. Large Signal Transient Response

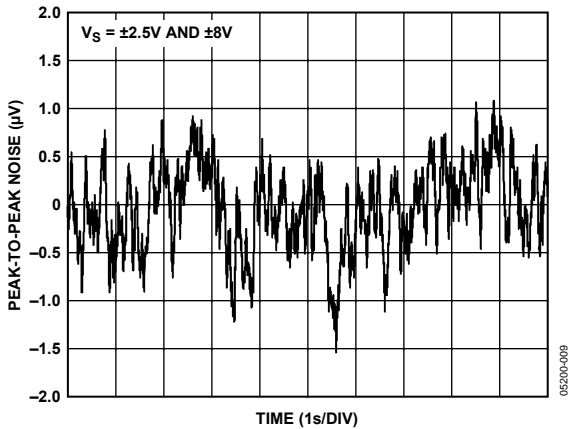

Figure 21. 0.1 Hz to 10 Hz Input Voltage Noise

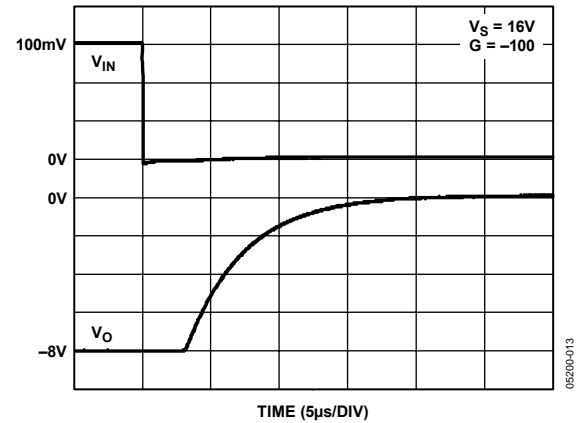

Figure 24. Positive Overload Recovery

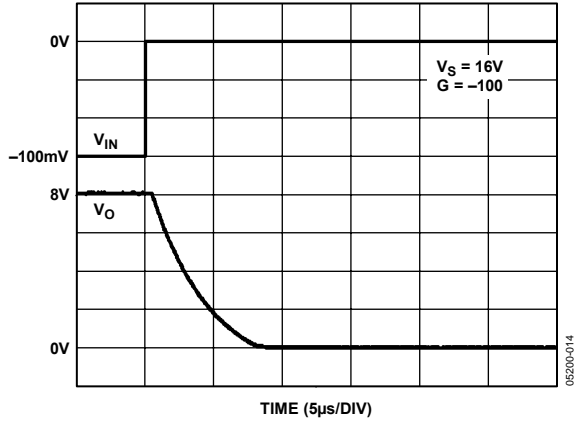

Figure 25. Negative Overload Recovery

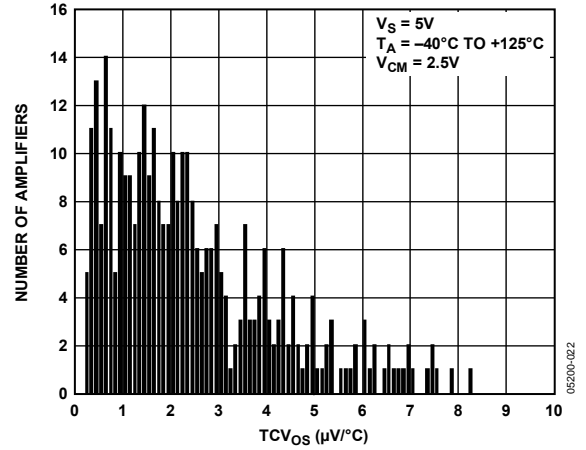

Figure 28. Offset Voltage Drift Distribution

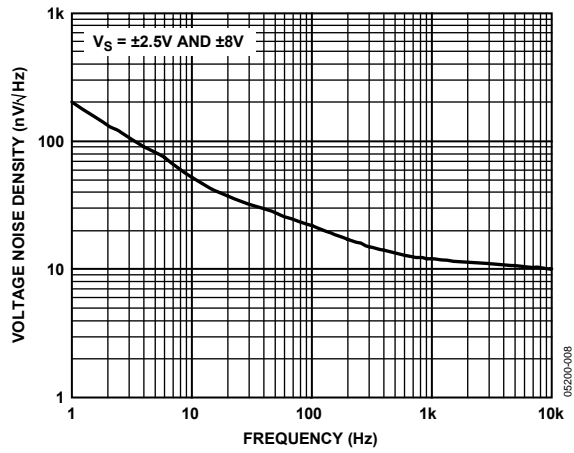

Figure 26. Voltage Noise Density vs. Frequency

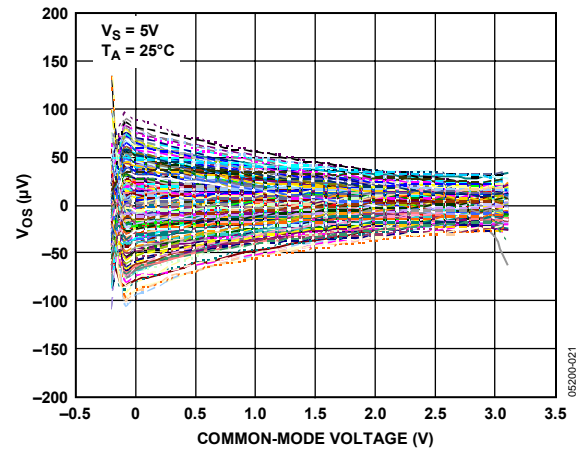

Figure 29. Input Offset Voltage vs. Common-Mode Voltage

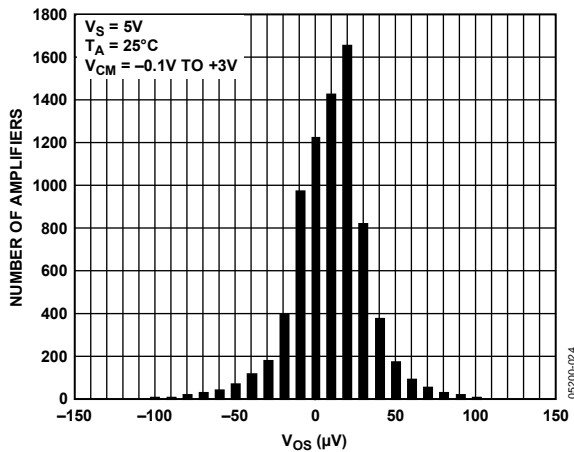

Figure 27. Input Offset Voltage Distribution

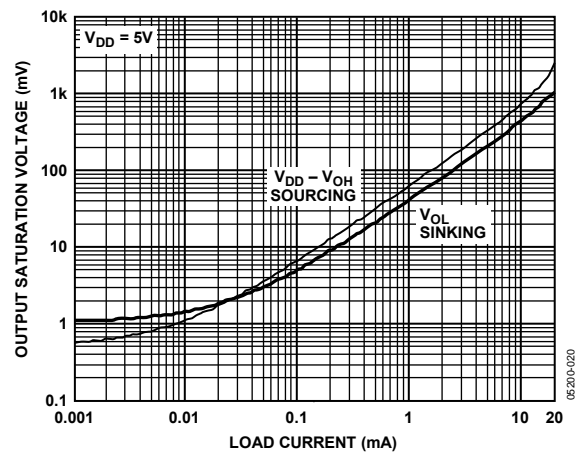

Figure 30. Output Swing Saturation Voltage vs. Load Current

AD8661/AD8662/AD8664

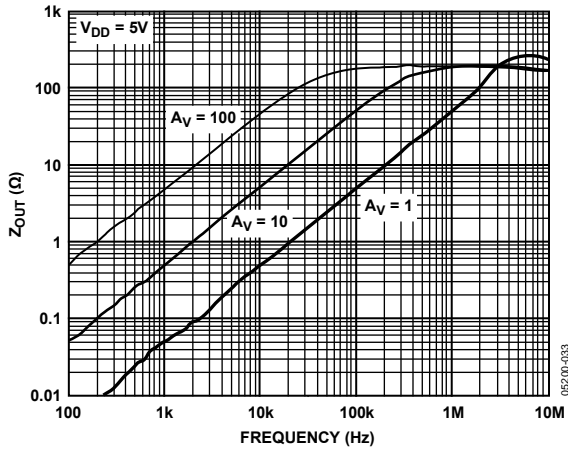

Figure 31. Closed-Loop Output Impedance vs. Frequency

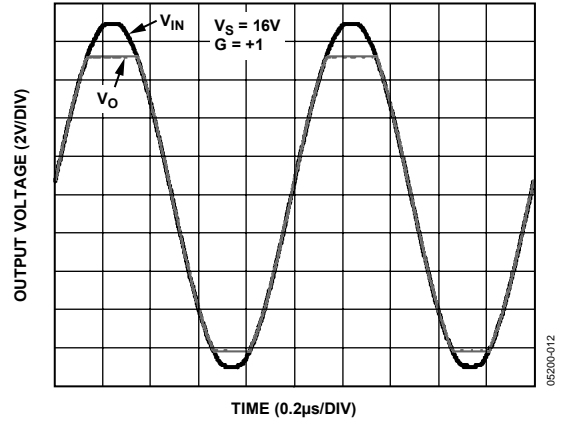

Figure 33. No Phase Reversal

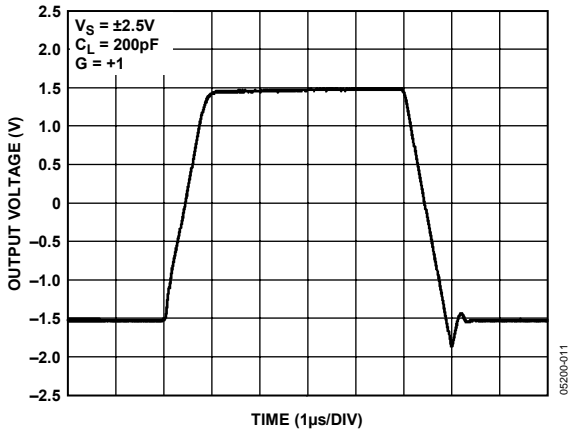
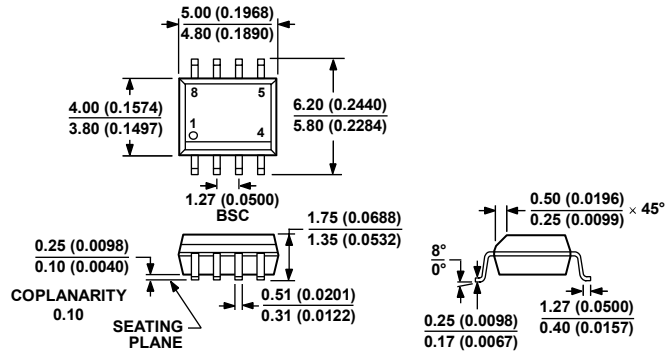

Figure 32. Large Signal Transient Response

OUTLINE DIMENSIONS



COMPLIANT TO JEDEC STANDARDS MS-012-AA
 CONTROLLING DIMENSIONS ARE IN MILLIMETERS; INCH DIMENSIONS
 (IN PARENTHESES) ARE ROUNDED-OFF MILLIMETER EQUIVALENTS FOR
 REFERENCE ONLY AND ARE NOT APPROPRIATE FOR USE IN DESIGN.

066906-A

Figure 34. 8-Lead Small Outline Package [SOIC_N]
 Narrow Body
 (R-8)

Dimensions shown in millimeters and (inches)

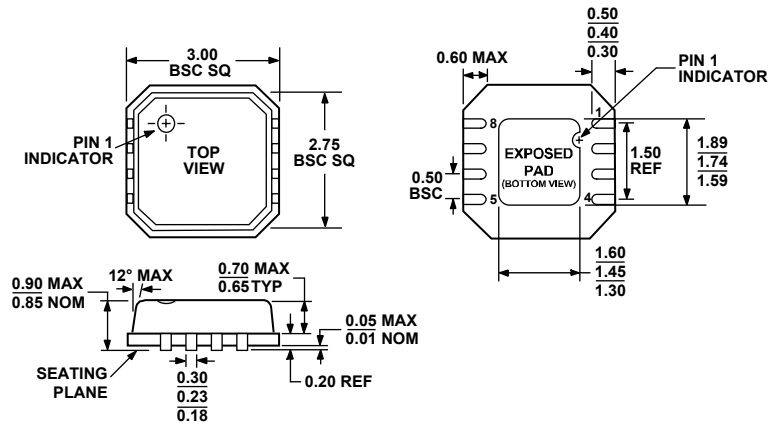
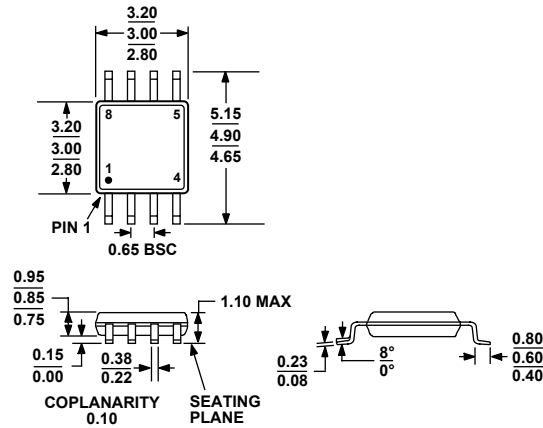

Figure 35. 8-Lead Lead Frame Chip Scale Package [LFCSP_VD]
 3 mm x 3 mm Body, Very Thin, Dual Lead
 (CP-8-2)

Dimensions shown in millimeters

AD8661/AD8662/AD8664



COMPLIANT TO JEDEC STANDARDS MO-187-AA

Figure 36. 8-Lead Mini Small Outline Package [MSOP]
(RM-8)
Dimensions shown in millimeters

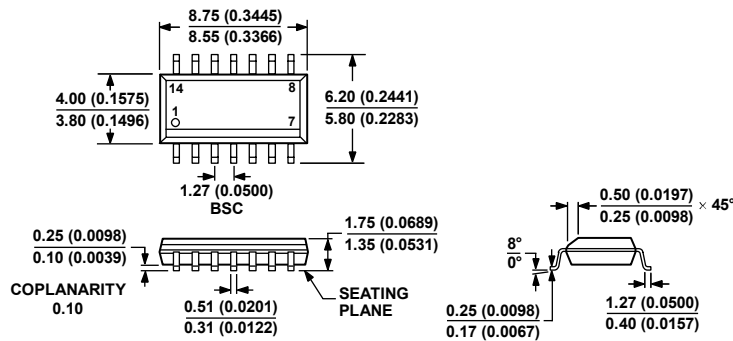

COMPLIANT TO JEDEC STANDARDS MS-012-AB

CONTROLLING DIMENSIONS ARE IN MILLIMETERS; INCH DIMENSIONS (IN PARENTHESES) ARE ROUNDED-OFF MILLIMETER EQUIVALENTS FOR REFERENCE ONLY AND ARE NOT APPROPRIATE FOR USE IN DESIGN.

Figure 37. 14-Lead Standard Small Outline Package [SOIC_N]
Narrow Body
(R-14)
Dimensions shown in millimeters and (inches)

060606-A

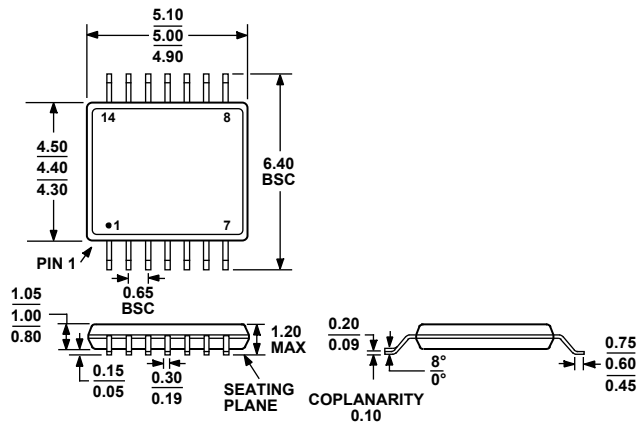

COMPLIANT TO JEDEC STANDARDS MO-153-AB-1

Figure 38. 14-Lead Thin Shrink Small Outline Package [TSSOP]
(RU-14)
Dimensions shown in millimeters

ORDERING GUIDE

Model	Temperature Range	Package Description	Package Option	Branding
AD8661ARZ ¹	-40°C to +125°C	8-Lead SOIC_N	R-8	
AD8661ARZ-REEL ¹	-40°C to +125°C	8-Lead SOIC_N	R-8	
AD8661ARZ-REEL7 ¹	-40°C to +125°C	8-Lead SOIC_N	R-8	
AD8661ACPZ-R2 ¹	-40°C to +85°C	8-Lead LFCSP_VD	CP-8-2	A0M
AD8661ACPZ-REEL ¹	-40°C to +85°C	8-Lead LFCSP_VD	CP-8-2	A0M
AD8661ACPZ-REEL7 ¹	-40°C to +85°C	8-Lead LFCSP_VD	CP-8-2	A0M
AD8662ARZ ¹	-40°C to +125°C	8-Lead SOIC_N	R-8	
AD8662ARZ-REEL ¹	-40°C to +125°C	8-Lead SOIC_N	R-8	
AD8662ARZ-REEL7 ¹	-40°C to +125°C	8-Lead SOIC_N	R-8	
AD8662ARMZ-R2 ¹	-40°C to +125°C	8-Lead MSOP	RM-8	A10
AD8662ARMZ-REEL ¹	-40°C to +125°C	8-Lead MSOP	RM-8	A10
AD8664ARZ ¹	-40°C to +125°C	14-Lead SOIC_N	R-14	
AD8664ARZ-REEL ¹	-40°C to +125°C	14-Lead SOIC_N	R-14	
AD8664ARZ-REEL7 ¹	-40°C to +125°C	14-Lead SOIC_N	R-14	
AD8664ARUZ ¹	-40°C to +125°C	14-Lead TSSOP	RU-14	
AD8664ARUZ-REEL ¹	-40°C to +125°C	14-Lead TSSOP	RU-14	

¹ Z = Pb-free part.

NOTES

Mouser Electronics

Authorized Distributor

Click to View Pricing, Inventory, Delivery & Lifecycle Information:

[Analog Devices Inc.:](#)

[AD8661ARZ](#) [AD8662ARMZ](#) [AD8662ARZ](#) [AD8664ARUZ](#) [AD8664ARZ](#) [AD8661ACPZ-R2](#) [AD8661ACPZ-REEL7](#)
[AD8661ARZ-REEL](#) [AD8661ARZ-REEL7](#) [AD8662ARMZ-REEL](#) [AD8662ARZ-REEL](#) [AD8662ARZ-REEL7](#)
[AD8664ARUZ-REEL](#) [AD8664ARZ-REEL](#) [AD8664ARZ-REEL7](#)