

## FEATURES

- Low  $R_{DS(on)}$ : 10 m $\Omega$  (WLCSP) or 27 m $\Omega$  (LFCSP)
- Wide input voltage range: 1.8 V to 5.5 V
- Quick output discharge (QOD) circuit ([ADP196-01](#))
- 3 A continuous operating current to 70°C
- 1.2 V logic-compatible enable input
- Low 25  $\mu$ A quiescent current,  $V_{IN} = 1.8$  V
- Low 40  $\mu$ A quiescent current,  $V_{IN} = 5.5$  V
- Overtemperature and overcurrent protection
- Ultralow shutdown current: <1  $\mu$ A
- Ultrasmall 1.0 mm  $\times$  1.5 mm, 0.5 mm pitch, 6-ball WLCSP
- Tiny 2.0 mm  $\times$  2.0 mm  $\times$  0.55 mm, 0.65 mm pitch, 6-lead LFCSP

## APPLICATIONS

- Mobile phones
- Digital cameras and audio devices
- Portable and battery-powered equipment

## GENERAL DESCRIPTION

The [ADP196](#) is a high-side load switch designed for operation from 1.8 V to 5.5 V. This load switch provides power domain isolation, helping to extend battery operation. The device contains a low on-resistance, N-channel MOSFET that supports more than 3 A of continuous current and minimizes power loss. In addition,  $R_{DS(on)}$  is constant, independent of the  $V_{IN}$  voltage. The low 25  $\mu$ A quiescent current and ultralow shutdown current make the [ADP196](#) ideal for battery-powered portable equipment. The built-in level shifter for enable logic makes the [ADP196](#) compatible with many processors and GPIO controllers.

Overtemperature protection circuitry is activated if the junction temperature exceeds 125°C, thereby protecting the [ADP196](#) and downstream circuits from potential damage. Overcurrent protection is provided in the form of constant current limiting.

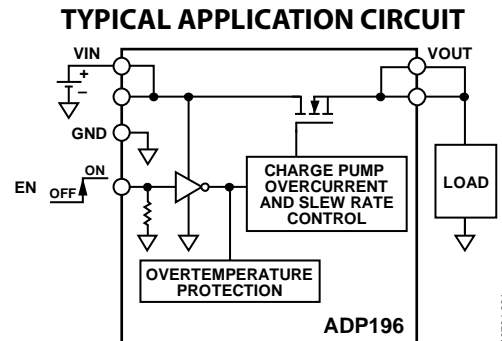

Figure 1.

10704-001

The [ADP196-01](#) incorporates an internal quick output discharge circuit to discharge the output capacitance when the [ADP196-01](#) output is disabled.

The [ADP196](#) in the WLCSP package occupies minimal printed circuit board (PCB) area with a footprint of less than 1.5 mm<sup>2</sup> and a height of 0.60 mm.

The [ADP196](#) is available in an ultrasmall, 1.0 mm  $\times$  1.5 mm, 0.5 mm pitch, 6-ball WLCSP and a 2.0 mm  $\times$  2.0 mm  $\times$  0.55 mm, 0.65 mm pitch, 6-lead LFCSP.

**TABLE OF CONTENTS**

Features .....	1	Typical Performance Characteristics .....	6
Applications.....	1	Theory of Operation .....	9
Typical Application Circuit .....	1	Applications Information .....	10
General Description .....	1	Capacitor Selection .....	10
Revision History .....	2	Ground Current.....	10
Specifications.....	3	Enable Feature .....	10
Timing Diagram .....	3	Timing.....	11
Absolute Maximum Ratings.....	4	Current-Limit and Thermal Overload Protection.....	11
Thermal Resistance .....	4	Outline Dimensions .....	12
ESD Caution.....	4	Ordering Guide .....	12
Pin Configurations and Function Descriptions .....	5		

**REVISION HISTORY**

3/13—Revision 0: Initial Version

## SPECIFICATIONS

$V_{IN} = 1.8\text{ V}$ ,  $V_{EN} = V_{IN}$ ,  $I_{OUT} = 1\text{ A}$ ,  $T_A = 25^\circ\text{C}$ ,  $T_J = -40^\circ\text{C}$  to  $+85^\circ\text{C}$  for minimum/maximum specifications, unless otherwise noted.

Table 1.

Parameter	Symbol	Test Conditions/Comments	Min	Typ	Max	Unit
INPUT VOLTAGE RANGE	$V_{IN}$	$T_J = -40^\circ\text{C}$ to $+85^\circ\text{C}$	1.8		5.5	V
EN INPUT						
EN Input Logic High	$V_{IH}$	$V_{IN} = 1.8\text{ V}$ to $5.5\text{ V}$	1.2			V
EN Input Logic Low	$V_{IL}$	$V_{IN} = 1.8\text{ V}$ to $5.5\text{ V}$			0.4	V
EN Input Pull-Down Current	$I_{EN}$	$V_{IN} = 1.8\text{ V}$		500		nA
CURRENT						
Ground Current	$I_{GND}$	$V_{IN} = 1.8\text{ V}$ $V_{IN} = 3.4\text{ V}$ $V_{IN} = 4.2\text{ V}$ $V_{IN} = 5.5\text{ V}$		25 25 30 40		$\mu\text{A}$ $\mu\text{A}$ $\mu\text{A}$ $\mu\text{A}$
Shutdown Current	$I_{OFF}$	$V_{EN} = \text{GND}$ , $V_{OUT} = 0\text{ V}$ , $V_{IN} = 4.2\text{ V}$ $V_{EN} = \text{GND}$ , $V_{OUT} = 0\text{ V}$ , $V_{IN} = 1.8\text{ V}$ to $5.5\text{ V}$		0.25	40	$\mu\text{A}$ $\mu\text{A}$
Continuous Operating Current <sup>1</sup>	$I_{OUT}$	$V_{IN} = 1.8\text{ V}$ to $5.5\text{ V}$		3		A
VIN TO VOUT ON RESISTANCE	$R_{DS(ON)}$					
WLCSP		$V_{IN} = 5.5\text{ V}$ $V_{IN} = 4.2\text{ V}$ $V_{IN} = 1.8\text{ V}$		0.01 0.01 0.01	0.015	$\Omega$ $\Omega$ $\Omega$
LFCSP		$V_{IN} = 5.5\text{ V}$ $V_{IN} = 4.2\text{ V}$ $V_{IN} = 1.8\text{ V}$		0.027 0.027 0.027	0.036	$\Omega$ $\Omega$ $\Omega$
VOUT TURN-ON DELAY TIME		See Figure 2				
Turn-On Delay Time	$t_{ON\_DLY}$	$V_{IN} = 1.8\text{ V}$ to $5.5\text{ V}$ , $C_{LOAD} = 1\text{ }\mu\text{F}$		2		ms
ACTIVE PULL-DOWN RESISTANCE (ADP196-01 OPTION ONLY)	$R_{PULLDOWN}$	$V_{IN} = 3.2\text{ V}$		370		$\Omega$
CURRENT-LIMIT THRESHOLD	$I_{LIM}$	$V_{IN} = 1.8\text{ V}$ to $5.5\text{ V}$ , $C_{LOAD} = 1\text{ }\mu\text{F}$	3.1	4		A
THERMAL SHUTDOWN						
Thermal Shutdown Threshold	$T_{SD}$	$T_J$ rising		125		$^\circ\text{C}$
Thermal Shutdown Hysteresis	$T_{SD-HYS}$			15		$^\circ\text{C}$

<sup>1</sup> At an ambient temperature of  $85^\circ\text{C}$ , the part can withstand a continuous current of 2.22 A. At a load current of 3 A, the operational lifetime derates to 2190 hours.

## TIMING DIAGRAM

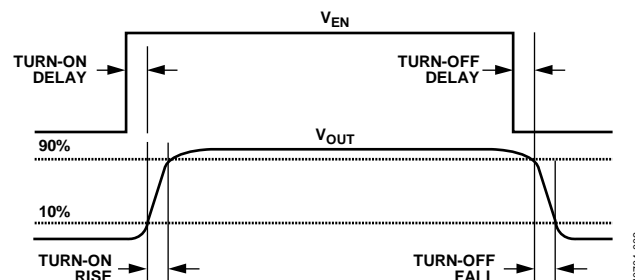

Figure 2. Timing Diagram

## ABSOLUTE MAXIMUM RATINGS

Table 2.

Parameter	Rating
VIN to GND	−0.3 V to +6.5 V
VOU to GND	−0.3 V to VIN
EN to GND	−0.3 V to +6.5 V
Continuous Drain Current	
TA = 25°C	±4 A
TA = 85°C	±2.22 A
Continuous Diode Current	−50 mA
Storage Temperature Range	−65°C to +150°C
Operating Junction Temperature Range	−40°C to +105°C
Soldering Conditions	JEDEC J-STD-020

Stresses above those listed under Absolute Maximum Ratings may cause permanent damage to the device. This is a stress rating only; functional operation of the device at these or any other conditions above those indicated in the operational section of this specification is not implied. Exposure to absolute maximum rating conditions for extended periods may affect device reliability.

## THERMAL RESISTANCE

Table 3. Typical  $\theta_{JA}$  and  $\Psi_{JB}$  Values

Package Type	$\theta_{JA}$	$\Psi_{JB}$	Unit
6-Ball WLCSP	260	58	°C/W
6-Lead LFCSP	68.9	44.1	°C/W

## ESD CAUTION



**ESD (electrostatic discharge) sensitive device.** Charged devices and circuit boards can discharge without detection. Although this product features patented or proprietary protection circuitry, damage may occur on devices subjected to high energy ESD. Therefore, proper ESD precautions should be taken to avoid performance degradation or loss of functionality.

## PIN CONFIGURATIONS AND FUNCTION DESCRIPTIONS

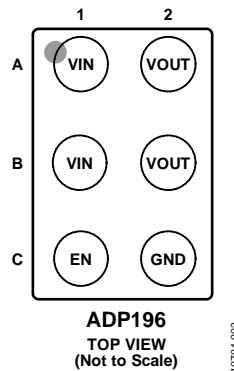

10704-003

Figure 3. 6-Ball WLCSP Pin Configuration

Table 4. 6-Ball WLCSP Pin Function Descriptions

Pin No.	Mnemonic	Description
A1, B1	VIN	Input Voltage.
A2, B2	VOUT	Output Voltage.
C1	EN	Enable Input. Drive EN high to turn on the switch, or drive EN low to turn off the switch.
C2	GND	Ground.

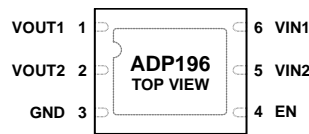

NOTES  
1. EXPOSED PAD MUST BE CONNECTED TO GROUND.

10704-004

Figure 4. 6-Lead LFCSP Pin Configuration

Table 5. 6-Lead LFCSP Pin Function Descriptions

Pin No.	Mnemonic	Description
1	VOUT1	Output Voltage. Connect VOUT1 and VOUT2 together.
2	VOUT2	Output Voltage. Connect VOUT1 and VOUT2 together.
3	GND	Ground.
4	EN	Enable Input. Drive EN high to turn on the switch, or drive EN low to turn off the switch.
5	VIN2	Input Voltage. Connect VIN1 and VIN2 together.
6	VIN1	Input Voltage. Connect VIN1 and VIN2 together.
	EP	The exposed pad must be connected to ground.

# TYPICAL PERFORMANCE CHARACTERISTICS

$V_{IN} = 1.8\text{ V}$ ,  $V_{EN} = V_{IN}$ ,  $C_{IN} = C_{OUT} = 1\ \mu\text{F}$ ,  $T_A = 25^\circ\text{C}$ , unless otherwise noted.

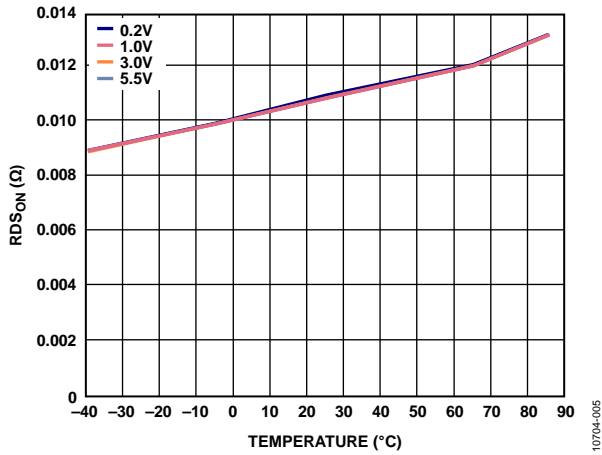

Figure 5.  $R_{DS(on)}$  vs. Temperature,  $I_{OUT} = 50\text{ mA}$ , Different Input Voltages ( $V_{IN}$ )

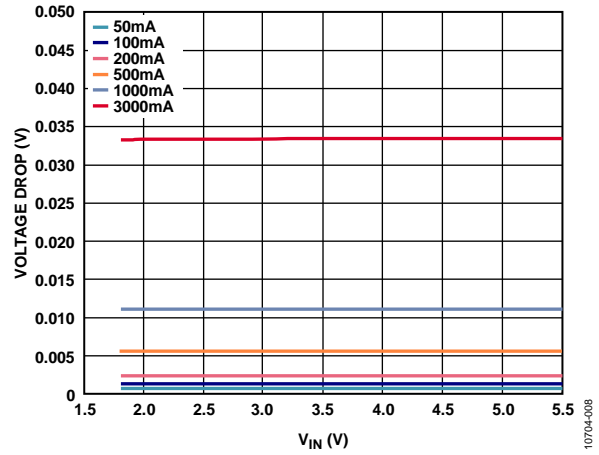

Figure 8. Voltage Drop vs. Input Voltage ( $V_{IN}$ ), Different Load Currents

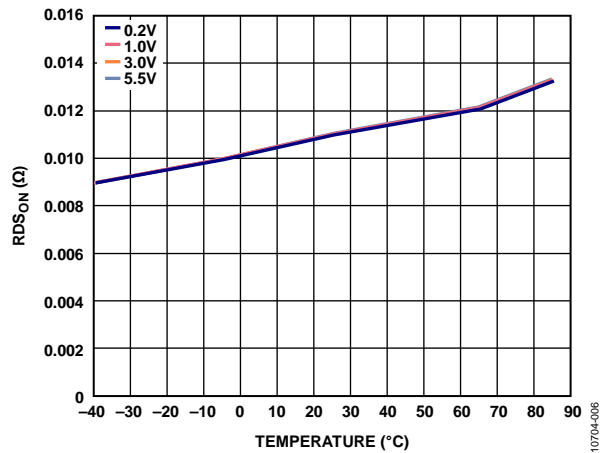

Figure 6.  $R_{DS(on)}$  vs. Temperature,  $I_{OUT} = 3\text{ A}$ , Different Input Voltages ( $V_{IN}$ )

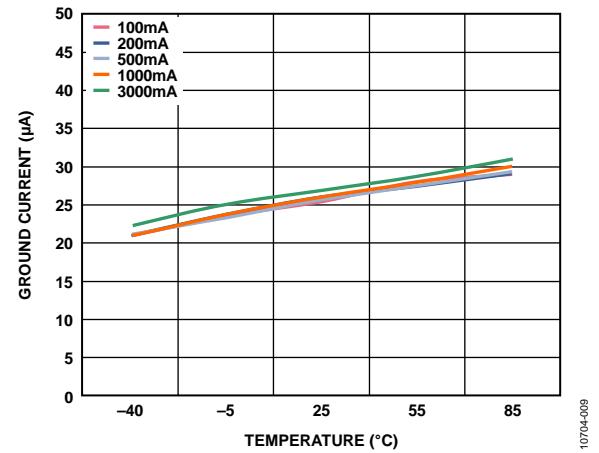

Figure 9. Ground Current vs. Temperature, Different Load Currents,  $V_{IN} = 1.8\text{ V}$

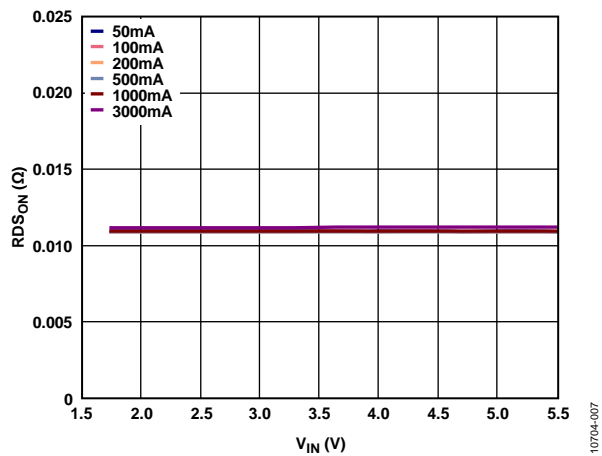

Figure 7.  $R_{DS(on)}$  vs. Input Voltage ( $V_{IN}$ ), Different Load Currents

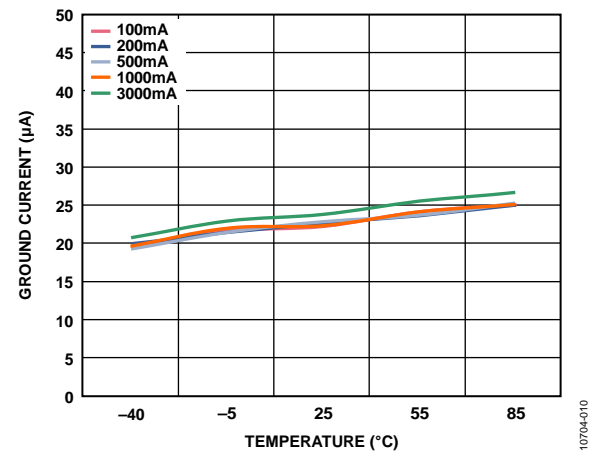

Figure 10. Ground Current vs. Temperature, Different Load Currents,  $V_{IN} = 3.3\text{ V}$

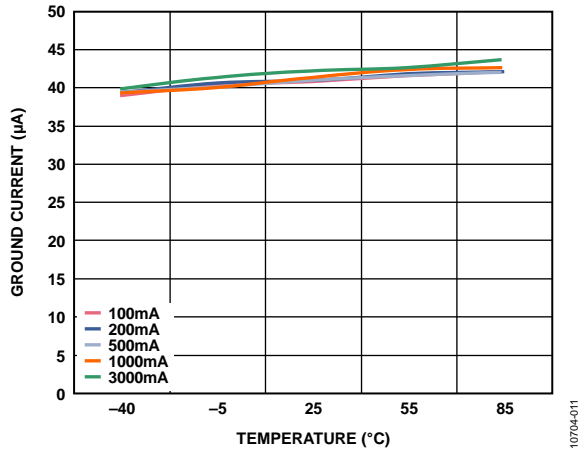

Figure 11. Ground Current vs. Temperature, Different Load Currents,  $V_{IN} = 5.5V$

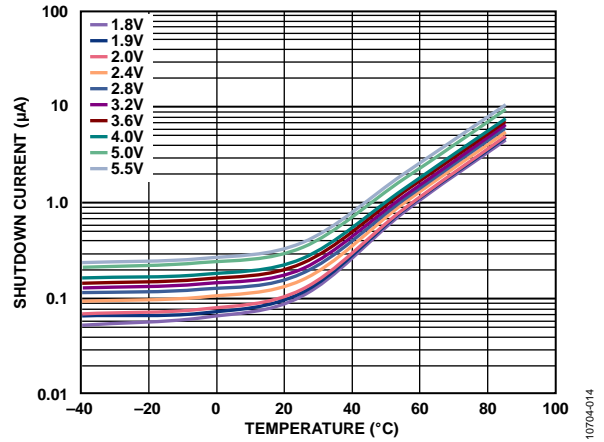

Figure 14. Shutdown Current vs. Temperature,  $V_{OUT} = 0V$ , Different Input Voltages ( $V_{IN}$ )

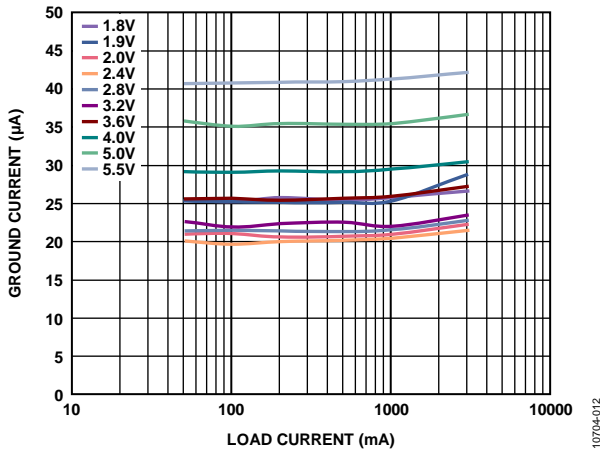

Figure 12. Ground Current vs. Load Current, Different Input Voltages ( $V_{IN}$ )

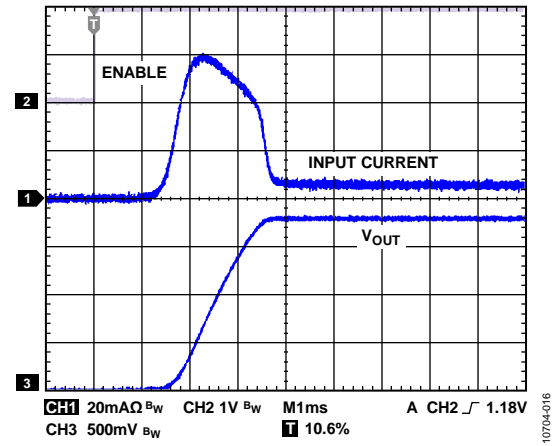

Figure 15. Typical Turn-On Time and Inrush Current,  $V_{IN} = 1.8V$ ,  $C_{OUT} = 47\mu F$ ,  $330\Omega$  Load

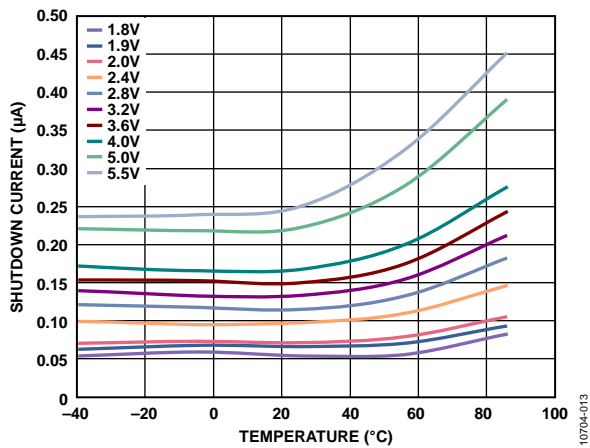

Figure 13. Shutdown Current vs. Temperature, Output Open, Different Input Voltages ( $V_{IN}$ )

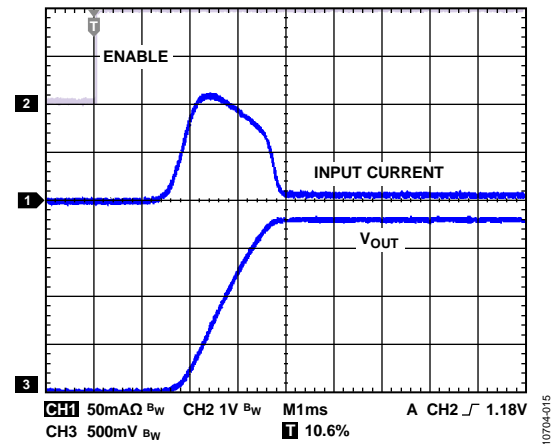

Figure 16. Typical Turn-On Time and Inrush Current,  $V_{IN} = 1.8V$ ,  $C_{OUT} = 100\mu F$ ,  $330\Omega$  Load

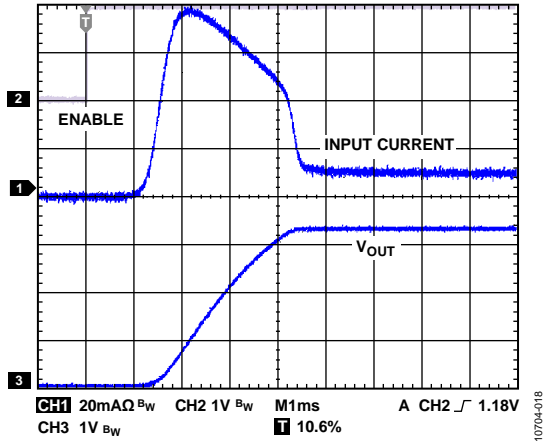

Figure 17. Typical Turn-On Time and Inrush Current,  $V_{IN} = 3.3\text{ V}$ ,  $C_{OUT} = 47\ \mu\text{F}$ ,  $330\ \Omega$  Load

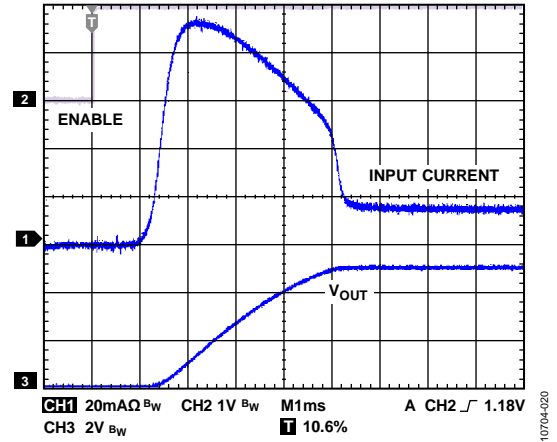

Figure 19. Typical Turn-On Time and Inrush Current,  $V_{IN} = 5\text{ V}$ ,  $C_{OUT} = 47\ \mu\text{F}$ ,  $330\ \Omega$  Load

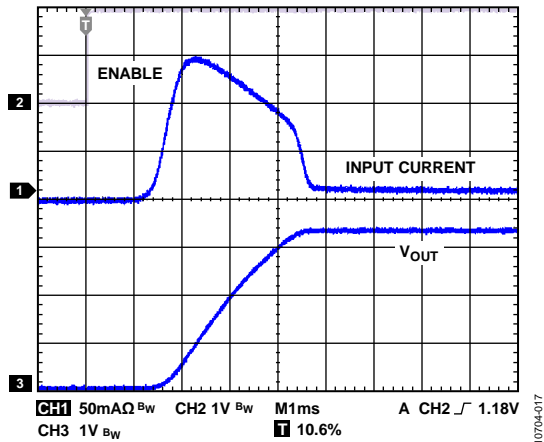

Figure 18. Typical Turn-On Time and Inrush Current,  $V_{IN} = 3.3\text{ V}$ ,  $C_{OUT} = 100\ \mu\text{F}$ ,  $330\ \Omega$  Load

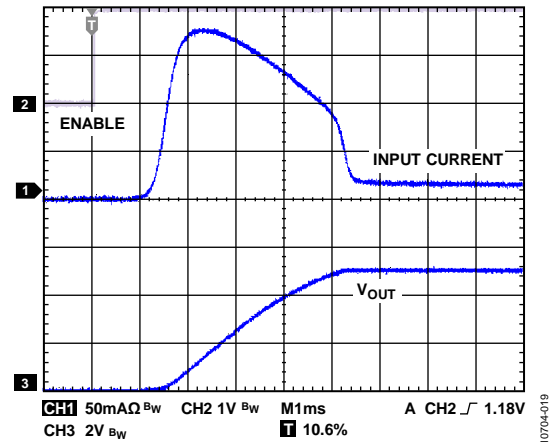

Figure 20. Typical Turn-On Time and Inrush Current,  $V_{IN} = 5\text{ V}$ ,  $C_{OUT} = 100\ \mu\text{F}$ ,  $330\ \Omega$  Load



## THEORY OF OPERATION

The **ADP196** is a high-side NMOS load switch controlled by an internal charge pump. The **ADP196** is designed to operate with power supply voltages from 1.8 V to 5.5 V.

An internal charge pump biases the NMOS switch to achieve a relatively constant, ultralow on resistance of 10 m $\Omega$  across the entire input voltage range (6-ball WLCSP package). The use of the internal charge pump also allows for controlled turn-on times. Turning the NMOS switch on and off is controlled by the enable input, EN, which is capable of interfacing directly to 1.2 V logic signals.

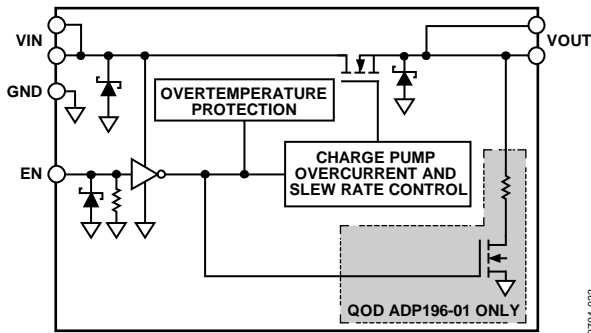

Figure 21. Functional Block Diagram

10704-022

The **ADP196** supports 3 A of continuous current as long as  $T_j$  is less than 70°C. At 85°C, the rated current decreases to 2.22 A. Overcurrent protection limits the output current to 4 A.

The overtemperature protection circuit is activated if the load current causes the junction temperature to exceed 125°C. When this occurs, the overtemperature protection circuitry disables the output until the junction temperature falls below approximately 110°C, at which point the output is reenabled. If the fault condition persists, the output cycles off and on until the fault is removed.

Additional protection is provided by an overcurrent limit that forces the device into a constant current mode of operation.

The **ADP196-01** incorporates a quick output discharge (QOD) circuit to discharge the output capacitance when the **ADP196-01** output is disabled.

ESD protection structures are shown in the block diagram as Zener diodes (see Figure 21).

The **ADP196** is a low quiescent current device with a nominal 4 M $\Omega$  pull-down resistor on its enable pin (EN).

The **ADP196** is available in a space-saving 1.0 mm  $\times$  1.5 mm, 0.5 mm pitch, 6-ball WLCSP and a tiny 2.0 mm  $\times$  2.0 mm  $\times$  0.55 mm, 0.65 mm pitch, 6-lead LFCSP.

## APPLICATIONS INFORMATION

### CAPACITOR SELECTION

#### Output Capacitor

The ADP196 is designed for operation with small, space-saving ceramic capacitors but functions with most commonly used capacitors when the effective series resistance (ESR) value is carefully considered. The ESR of the output capacitor affects the response to load transients. A typical 1  $\mu\text{F}$  capacitor with an ESR of 0.1  $\Omega$  or less is recommended for good transient response. Using a larger value of output capacitance improves the transient response to large changes in load current.

#### Input Bypass Capacitor

Connecting at least 1  $\mu\text{F}$  of capacitance from  $V_{\text{IN}}$  to GND reduces the circuit sensitivity to the PCB layout, especially when high source impedance or long input traces are encountered. When more than 1  $\mu\text{F}$  of output capacitance is required, increase the input capacitance to match it.

### GROUND CURRENT

The major source of ground current in the ADP196 is the internal charge pump for the FET drive circuitry. Figure 22 shows the typical ground current when  $V_{\text{EN}} = V_{\text{IN}}$  and varies from 1.8 V to 5.5 V.

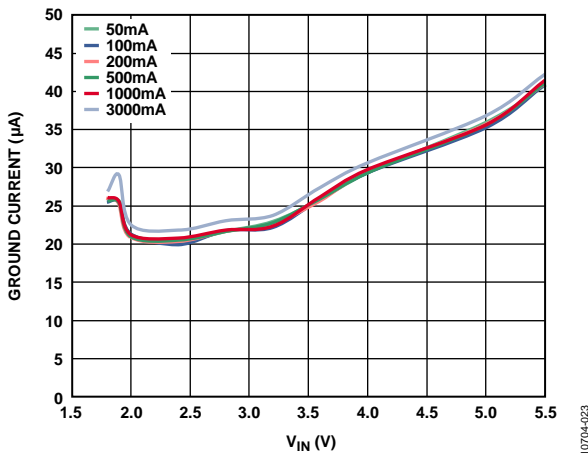

Figure 22. Ground Current vs. Input Voltage ( $V_{\text{IN}}$ ) for Different Load Currents

### ENABLE FEATURE

The ADP196 uses the EN pin to enable and disable the  $V_{\text{OUT}}$  pin under normal operating conditions. As shown in Figure 23, when a rising voltage ( $V_{\text{EN}}$ ) on the EN pin crosses the active threshold,  $V_{\text{OUT}}$  turns on. When a falling voltage ( $V_{\text{EN}}$ ) on the EN pin crosses the inactive threshold,  $V_{\text{OUT}}$  turns off.

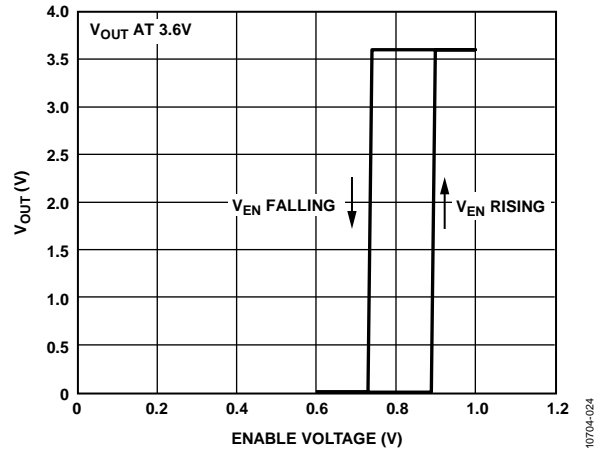

Figure 23. Typical EN Pin Operation

As shown in Figure 23, the EN pin has built-in hysteresis. The hysteresis prevents on/off oscillations that can occur due to noise on the EN pin as it passes through the threshold points.

The EN pin active/inactive thresholds are derived from the  $V_{\text{IN}}$  voltage; therefore, these thresholds vary with changing input voltage. Figure 24 shows the typical EN active/inactive thresholds when the input voltage varies from 1.8 V to 5.5 V.

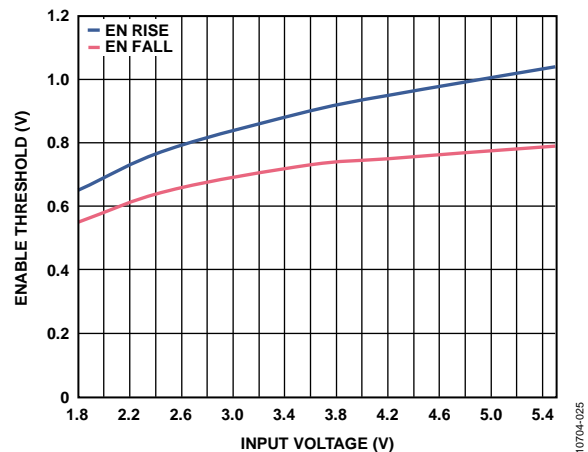

Figure 24. Typical EN Thresholds vs. Input Voltage ( $V_{\text{IN}}$ )

## TIMING

Turn-on delay is defined as the interval between the time that  $V_{EN}$  exceeds the rising threshold voltage and when  $V_{OUT}$  rises to  $\sim 10\%$  of its final value. The ADP196 includes circuitry that has a typical 2 ms turn-on delay and a controlled rise time to limit the  $V_{IN}$  inrush current. As shown in Figure 25 and Figure 26, the turn-on delay is nearly independent of the input voltage.

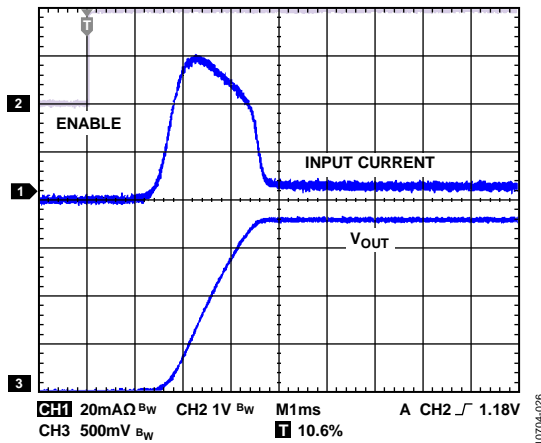

Figure 25. Typical Turn-On Time and Inrush Current,  $V_{IN} = 1.8\text{ V}$ ,  $C_{OUT} = 47\text{ }\mu\text{F}$ ,  $330\text{ }\Omega$  Load

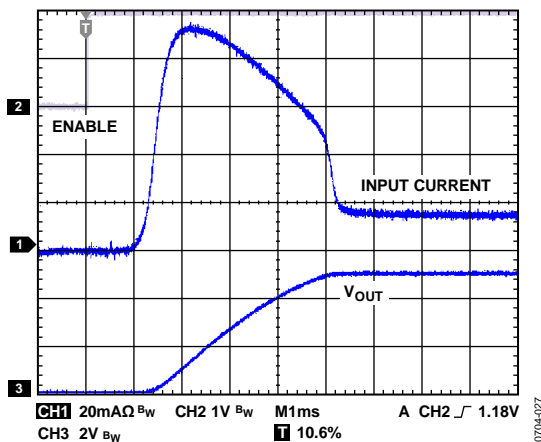

Figure 26. Typical Turn-On Time and Inrush Current,  $V_{IN} = 5\text{ V}$ ,  $C_{OUT} = 47\text{ }\mu\text{F}$ ,  $330\text{ }\Omega$  Load

The rise time is defined as the time it takes the output voltage to rise from 10% to 90% of  $V_{OUT}$  reaching its final value. The rise time is dependent on the rise time of the internal charge pump.

For very large values of output capacitance, the RC time constant (where C is the load capacitance,  $C_{LOAD}$ , and R is the  $R_{DS(ON)} || R_{LOAD}$ ) can become a factor in the rise time of the output voltage. Because  $R_{DS(ON)}$  is much smaller than  $R_{LOAD}$ , an adequate approximation for RC is  $R_{DS(ON)} \times C_{LOAD}$ . An input or load capacitor is not required for the ADP196; however, capacitors can be used to suppress noise on the board.

The turn-off time is defined as the time it takes for the output voltage to fall from 90% to 10% of  $V_{OUT}$  reaching its final value. The turn-off time is also dependent on the RC time constant of the output capacitance and load resistance. Figure 27 shows typical turn-off times with  $V_{IN} = 1.8\text{ V}$  to  $5\text{ V}$ ,  $C_{OUT} = 47\text{ }\mu\text{F}$ , and  $R_{LOAD} = 330\text{ }\Omega$ .

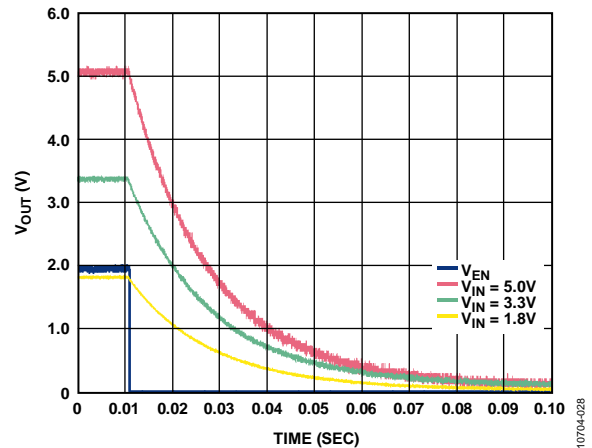

Figure 27. Typical Turn-Off Time

## CURRENT-LIMIT AND THERMAL OVERLOAD PROTECTION

The ADP196 is protected against damage due to excessive power dissipation by current-limit and thermal overload protection circuits. The ADP196 is designed to limit current when the output load reaches 4 A (typical). When the output load exceeds 4 A, the output voltage is reduced to maintain a constant current limit.

Thermal overload protection is included, which limits the junction temperature to a maximum of  $125^{\circ}\text{C}$  (typical). Under extreme conditions (that is, high ambient temperature and/or high power dissipation) when the junction temperature starts to rise above  $125^{\circ}\text{C}$ , the output is turned off, reducing the output current to zero. When the junction temperature falls below  $110^{\circ}\text{C}$ , the output is turned on again, and the output current is restored to its operating value.

Consider the case where a hard short from  $V_{OUT}$  to ground occurs. At first, the ADP196 current limits so that only 4 A is conducted into the short. If self-heating of the junction is great enough to cause its temperature to rise above  $125^{\circ}\text{C}$ , thermal shutdown is activated, turning off the output and reducing the output current to zero. As the junction temperature cools and falls below  $110^{\circ}\text{C}$ , the output turns on and conducts 4 A into the short, again causing the junction temperature to rise above  $125^{\circ}\text{C}$ . This thermal oscillation between  $110^{\circ}\text{C}$  and  $125^{\circ}\text{C}$  causes a current oscillation between 4 A and 0 mA that continues as long as the short remains at the output.

Current-limit and thermal overload protections are intended to protect the device against accidental overload conditions. For reliable operation, device power dissipation must be externally limited so that the junction temperature does not exceed  $125^{\circ}\text{C}$ .

OUTLINE DIMENSIONS

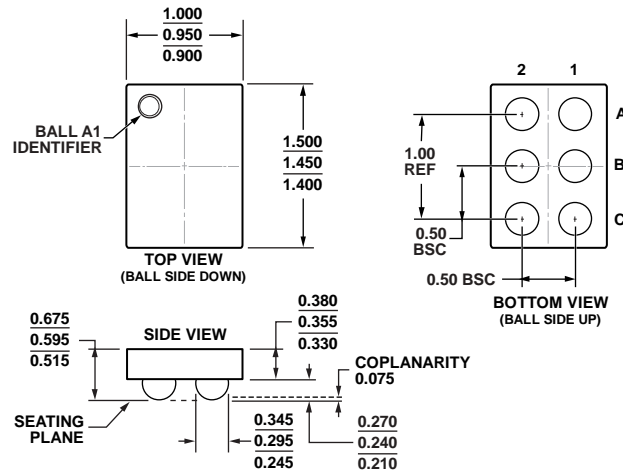

Figure 28. 6-Ball Wafer Level Chip Scale Package [WLCSP] (CB-6-2)

Dimensions shown in millimeters

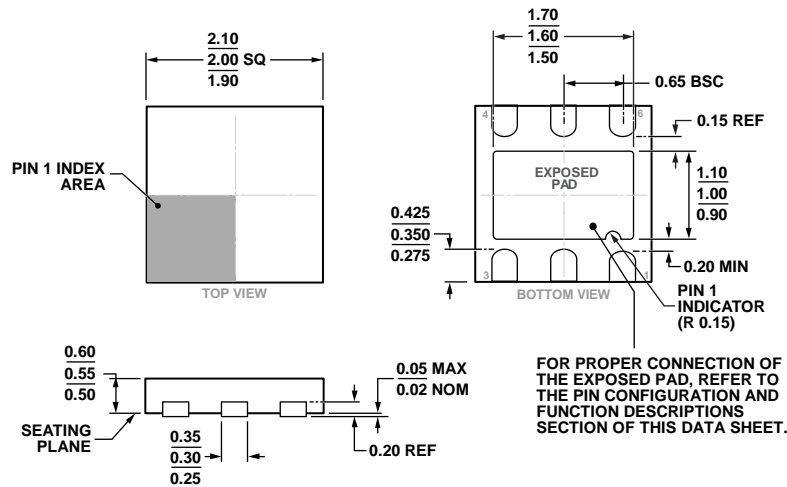

Figure 29. 6-Lead Lead Frame Chip Scale Package [LFCSP\_UD]

2.00 mm x 2.00 mm Body, Ultra Thin, Dual Lead (CP-6-3)

Dimensions shown in millimeters

ORDERING GUIDE

Model <sup>1</sup>	Temperature Range	Package Description	Package Option	Branding
ADP196ACBZ-R7	-40°C to +85°C	6-Ball Wafer Level Chip Scale Package [WLCSP]	CB-6-2	AW
ADP196ACPZN-R7	-40°C to +85°C	6-Lead Lead Frame Chip Scale Package [LFCSP_UD]	CP-6-3	AW
ADP196ACBZ-01-R7	-40°C to +85°C	6-Ball Wafer Level Chip Scale Package [WLCSP], Quick Output Discharge Option	CB-6-2	BK
ADP196ACPZN-01-R7	-40°C to +85°C	6-Lead Lead Frame Chip Scale Package [LFCSP_UD], Quick Output Discharge Option	CP-6-3	BK
ADP196CP-EVALZ		Evaluation Board		

<sup>1</sup> Z = RoHS Compliant Part.

# Mouser Electronics

Authorized Distributor

Click to View Pricing, Inventory, Delivery & Lifecycle Information:

[Analog Devices Inc.:](#)

[ADP196CP-EVALZ](#) [ADP196ACBZ-R7](#) [ADP196ACPZN-R7](#) [ADP196ACPZN-01-R7](#) [ADP196ACBZ-01-R7](#)