

# Analog Devices Welcomes Hittite Microwave Corporation

NO CONTENT ON THE ATTACHED DOCUMENT HAS CHANGED



**THIS PAGE INTENTIONALLY LEFT BLANK**



## SMT GaAs MMIC x2 ACTIVE FREQUENCY MULTIPLIER, 8 - 22 GHz OUTPUT

### Typical Applications

The HMC573LC3B is suitable for:

- Clock Generation Applications:  
SONET OC-192 & SDH STM-64
- Point-to-Point & VSAT Radios
- Test Instrumentation
- Military & Space

### Features

- High Output Power: +12 dBm
- Low Input Power Drive: 0 to +6 dBm
- Fo Isolation: >20 dBc @ Fout= 16 GHz
- 100 KHz SSB Phase Noise: -134 dBc/Hz
- Single Supply: +5V@ 92 mA
- RoHS Compliant 3x3 mm SMT Package

### Functional Diagram

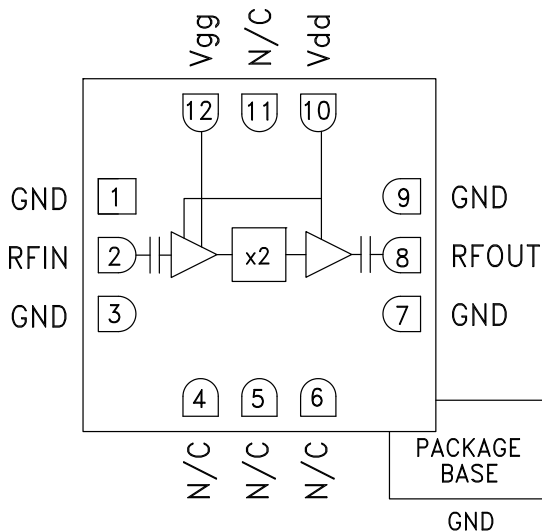

### General Description

The HMC573LC3B is a x2 active broadband frequency multiplier utilizing GaAs PHEMT technology in a leadless RoHS compliant SMT package. When driven by a +5 dBm signal, the multiplier provides +12 dBm typical output power from 8 to 22 GHz. The Fo and 3Fo isolations are >20 dBc and >25 dBc respectively at 16 GHz. The HMC573LC3B is ideal for use in LO multiplier chains for Pt-to-Pt & VSAT Radios yielding reduced parts count vs. traditional approaches. The low additive SSB Phase Noise of -134 dBc/Hz at 100 kHz offset helps maintain good system noise performance. The RoHS packaged HMC573LC3B eliminates the need for wire bonding, and allows the use of surface mount manufacturing techniques.

### Electrical Specifications, $T_A = +25^\circ\text{C}$ , $V_{dd} = +5\text{V}$ , 5 dBm Drive Level

Parameter	Min.	Typ.	Max.	Units
Frequency Range, Input	4 - 11			GHz
Frequency Range, Output	8 - 22			GHz
Output Power	9	12		dBm
Fo Isolation (with respect to output level)		20		dBc
3Fo Isolation (with respect to output level)		25		dBc
4Fo Isolation (with respect to output level)		15		dBc
Input Return Loss		10		dB
Output Return Loss		10		dB
SSB Phase Noise (100 kHz Offset)		-134		dBc/Hz
Supply Current (Idd) (Vdd = 5V, Vgg = -1.25V Typ.)		92		mA

\*Adjust Vgg between -1.5 and -1.1V to achieve Idd = 92 mA

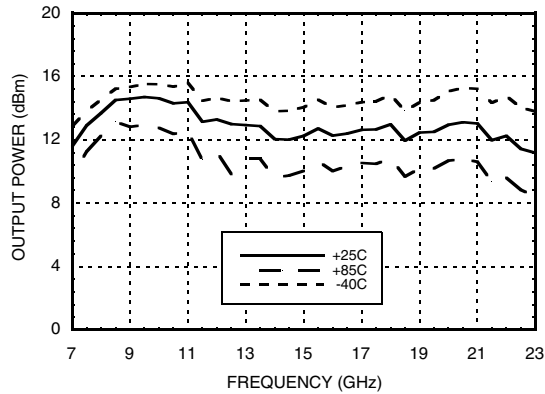
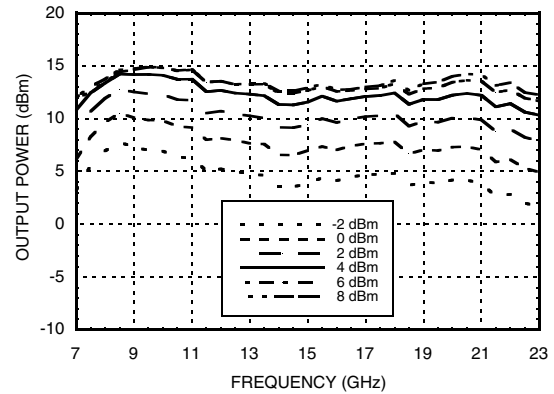
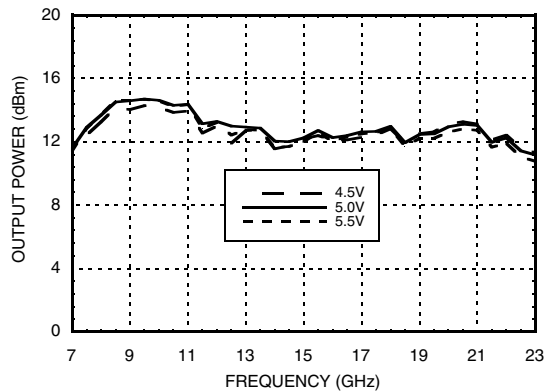
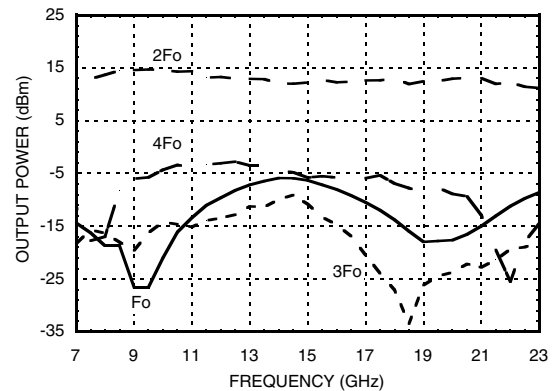
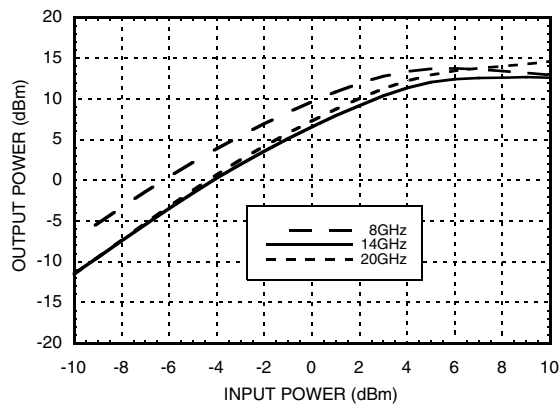
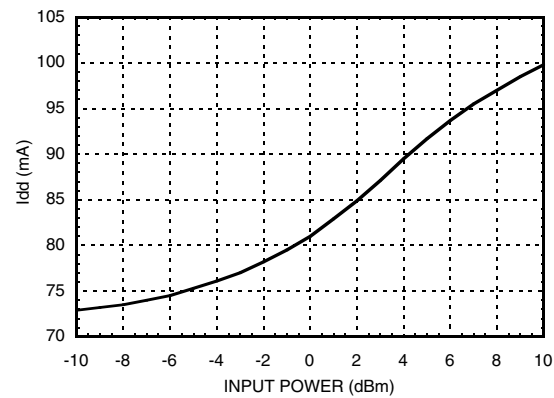
**SMT GaAs MMIC x2 ACTIVE FREQUENCY MULTIPLIER, 8 - 22 GHz OUTPUT**
**Output Power vs. Temperature @ 5 dBm Drive Level**

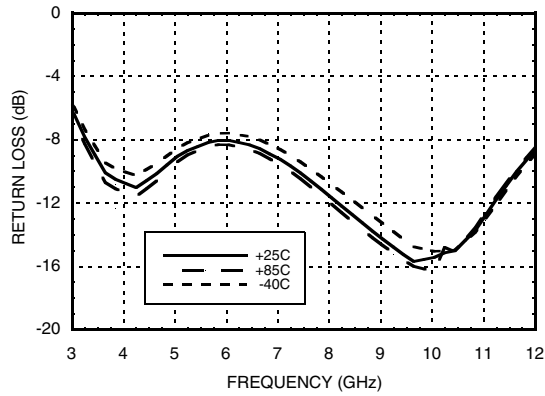
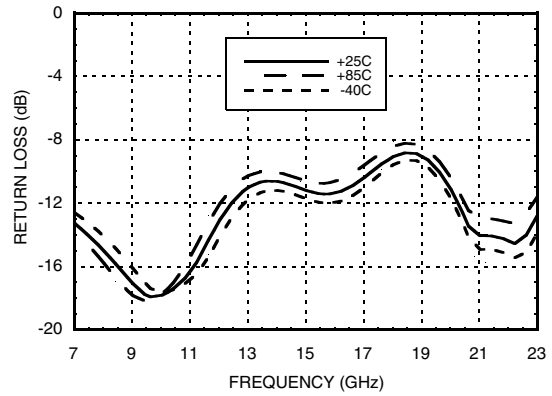
**Output Power vs. Drive Level**

**Output Power vs. Supply Voltage @ 5 dBm Drive Level**

**Isolation @ 5 dBm Drive Level**

**Output Power vs. Input Power**

**Supply Current vs. Input Power**



**SMT GaAs MMIC x2 ACTIVE FREQUENCY MULTIPLIER, 8 - 22 GHz OUTPUT**
**Input Return Loss vs. Temperature**

**Output Return Loss vs. Temperature**

## SMT GaAs MMIC x2 ACTIVE FREQUENCY MULTIPLIER, 8 - 22 GHz OUTPUT

### Absolute Maximum Ratings

RF Input (Vdd = +5V)	+10 dBm
Supply Voltage (Vdd)	+6.0 Vdc
Channel Temperature	175 °C
Continuous Pdiss (T= 85 °C) (derate 8.0 mW/°C above 85 °C)	719 mW
Thermal Resistance (channel to ground paddle)	125 °C/W
Storage Temperature	-65 to +150 °C
Operating Temperature	-40 to +85 °C
ESD Sensitivity (HBM)	Class 1A

### Typical Supply Current vs. Vdd

Vdd (Vdc)	Idd (mA)
4.5	90
5.0	92
5.5	94

Note:  
Multiplier will operate over full voltage range shown above.



ELECTROSTATIC SENSITIVE DEVICE  
OBSERVE HANDLING PRECAUTIONS

### Outline Drawing

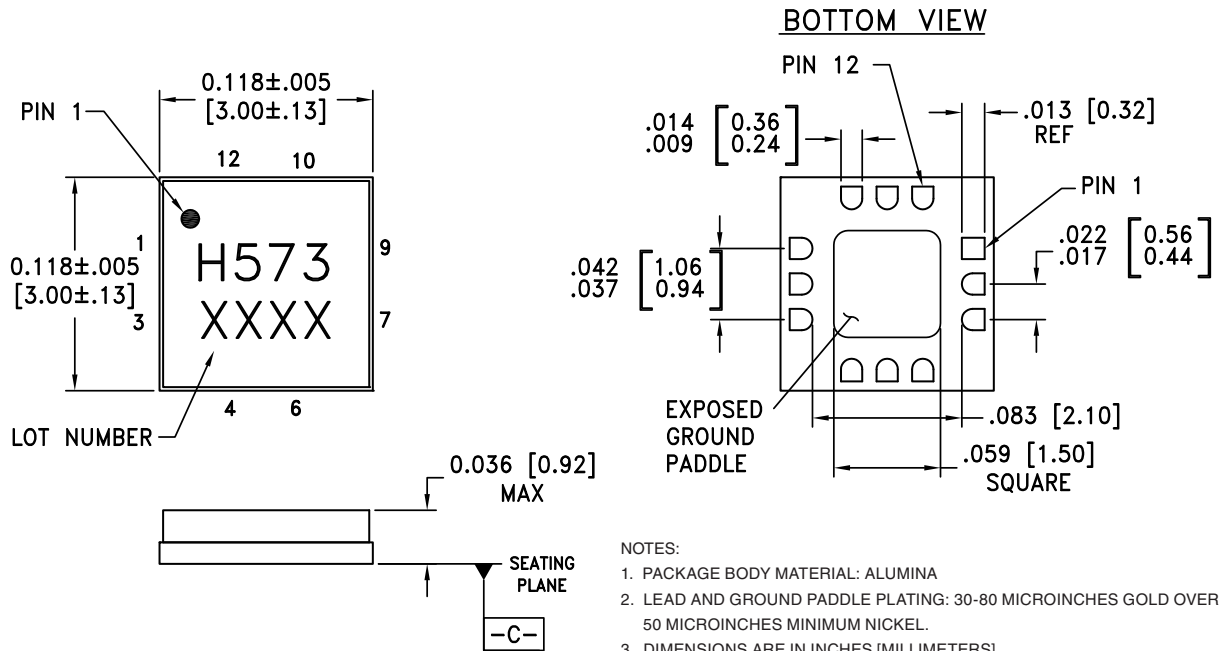

- NOTES:
1. PACKAGE BODY MATERIAL: ALUMINA
  2. LEAD AND GROUND PADDLE PLATING: 30-80 MICROINCHES GOLD OVER 50 MICROINCHES MINIMUM NICKEL.
  3. DIMENSIONS ARE IN INCHES [MILLIMETERS].
  4. LEAD SPACING TOLERANCE IS NON-CUMULATIVE
  5. PACKAGE WARP SHALL NOT EXCEED 0.05mm DATUM [-C-]
  6. ALL GROUND LEADS AND GROUND PADDLE MUST BE SOLDERED TO PCB RF GROUND.

### Package Information

Part Number	Package Body Material	Lead Finish	MSL Rating	Package Marking <sup>[2]</sup>
HMC573LC3B	Alumina, White	Gold over Nickel	MSL3 <sup>[1]</sup>	H573 XXXX

[1] Max peak reflow temperature of 260 °C

[2] 4-Digit lot number XXXX

**SMT GaAs MMIC x2 ACTIVE FREQUENCY MULTIPLIER, 8 - 22 GHz OUTPUT**
**Pin Description**

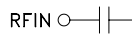
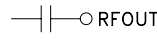
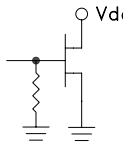
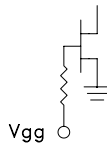
Pin Number	Function	Description	Interface Schematic
1, 3, 7, 9	GND	Package bottom must also be connected to RF/DC ground.	
2	RFIN	Pin is AC coupled and matched to 50 Ohms.	
4 - 6, 11	N/C	These pins are internally not connected; however, this product was specified with these pins connected to RF/DC ground.	
8	RFOUT	Pin is AC coupled and matched to 50 Ohms.	
10	Vdd	Supply voltage 5V ± 0.5V. External bypass capacitors of 100 pF, 1,000 pF and 2.2 μF are required.	
12	Vgg	Gate control for amplifier. Adjust to achieve I <sub>dd</sub> of 92 mA. Please follow "MMIC Amplifier Biasing Procedure" Application note.	

**Application Circuit**

Component	Value
C1, C2	100 pF
C3, C4	1,000 pF
C5, C6	2.2 μF

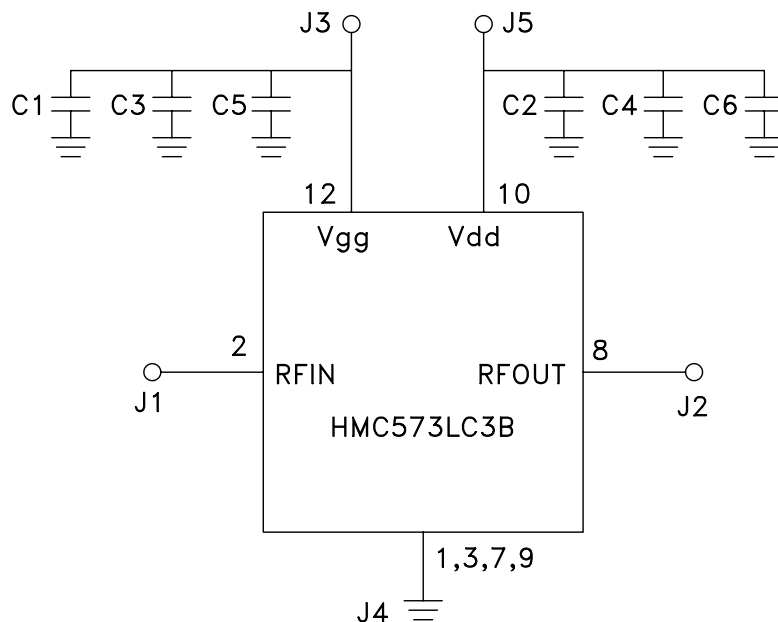



**SMT GaAs MMIC x2 ACTIVE FREQUENCY MULTIPLIER, 8 - 22 GHz OUTPUT**

**Evaluation PCB**

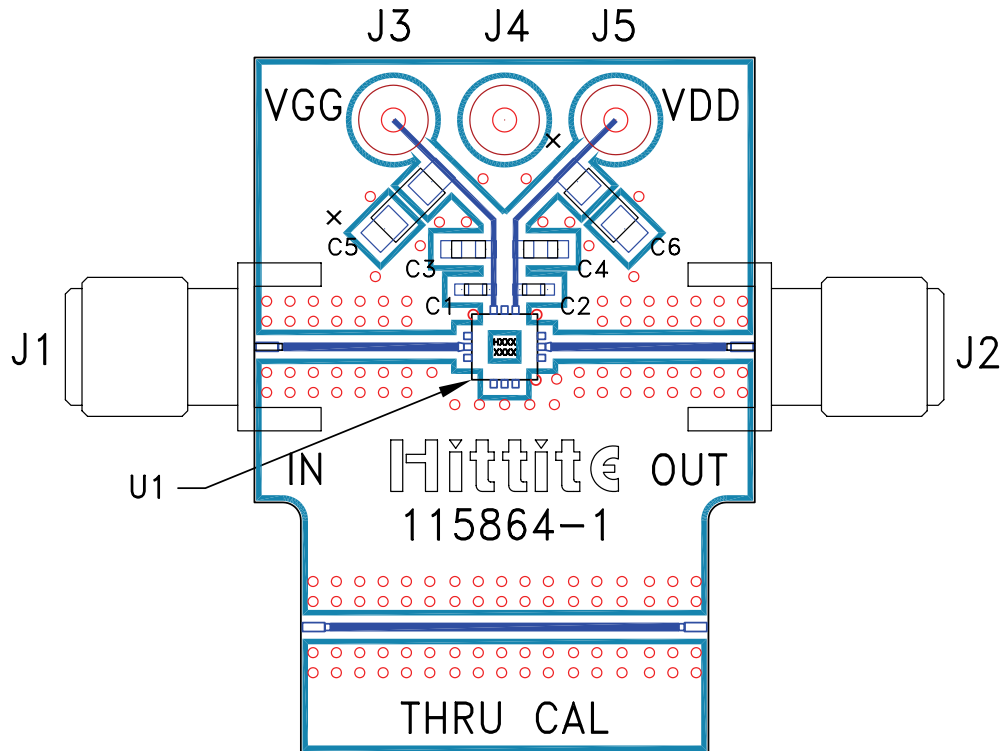

**List of Materials for Evaluation PCB 115739 [1]**

Item	Description
J1, J2	PCB Mount SRI K Connector
J3 - J5	DC Pin
C1, C2	100 pF Capacitor, 0402 Pkg.
C3, C4	1,000 pF Capacitor, 0603 Pkg.
C5, C6	2.2 $\mu$ F Tantalum Capacitor
U1	HMC573LC3B x2 Active Multiplier
PCB [2]	115864 Eval Board

[1] Reference this number when ordering complete evaluation PCB

[2] Circuit Board Material: Rogers 4350

The circuit board used in the final application should be generated with proper RF circuit design techniques. Signal lines should have 50 ohm impedance while the package ground leads and exposed paddle should be connected directly to the ground plane similar to that shown. A sufficient number of via holes should be used to connect the top and bottom ground planes. The evaluation circuit board shown is available from Hittite upon request.



# Mouser Electronics

Authorized Distributor

Click to View Pricing, Inventory, Delivery & Lifecycle Information:

[Analog Devices Inc.:](#)

[HMC573LC3B](#) [115739-HMC573LC3B](#) [HMC573LC3BTR](#) [HMC573LC3BTR-R5](#)