

Analog Devices Welcomes Hittite Microwave Corporation

NO CONTENT ON THE ATTACHED DOCUMENT HAS CHANGED



THIS PAGE INTENTIONALLY LEFT BLANK



SUCCESSIVE DETECTION LOG VIDEO AMPLIFIER (SDLVA), 0.1 - 20 GHz

Typical Applications

The HMC613LC4B is ideal for:

- EW, ELINT & IFM Receivers
- DF Radar Systems
- ECM Systems
- Broadband Test & Measurement
- Power Measurement & Control Circuits
- Military & Space Applications

Features

- Wide Input Bandwidth; 0.1 to 20 GHz
- High Logging Range: 59 dB (-54 to +5) @ 18 GHz
- Output Frequency Flatness: ± 1.5 dB
- Log Linearity: ± 1 dB
- Fast Rise/Fall Times: 4/18 ns
- Recovery Time: 26 ns
- Single Positive Supply: +3.3V
- Space Level Packaging Available
- 24 Lead 4x4mm SMT Package: 16mm²

Functional Diagram

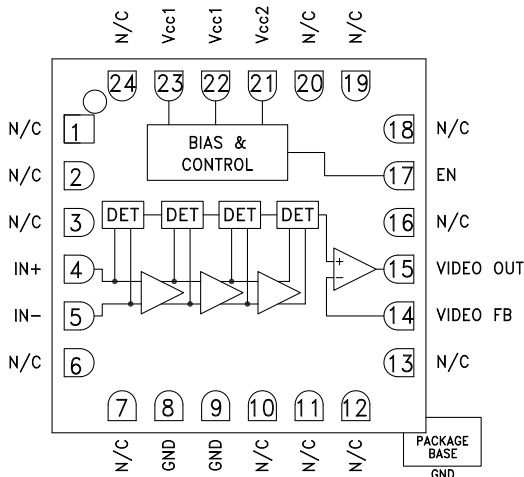

General Description

The HMC613LC4B is a Successive Detection Log Video Amplifier (SDLVA) which operates from 0.1 to 20 GHz. The HMC613LC4B provides a logging range of 59 dB. This device offers typical fast rise/fall times of 4/18 ns and a superior delay time of 14 ns. The HMC613LC4B log video output slope is typically 14 mV/dB. Maximum recovery times are less than 30 ns. The HMC613LC4B is available in a highly compact 4x4 mm SMT ceramic package and is ideal for high speed channelized receiver applications.

Electrical Specifications, $T_A = +25^\circ\text{C}$ $V_{cc1} = V_{cc2} = +3.3\text{V}$

Parameter	Conditions	Typ.	Units
Input Frequency Range [1][2]		0.1 to 20	GHz
Frequency Flatness	Pin = -25 dBm	± 1.5	dB
Log Linearity	Pin = -50 dBm to +3 dBm	± 1	dBm
Log Linearity over Temperature	Pin = -25dBm	± 1	dB
Minimum Logging Range	to ± 3 dB error	-54 @ 18 GHz	dBm
Maximum Logging Range	to ± 3 dB error	5 @ 18 GHz	dBm
Input Return Loss		8	dB
Log Video Minimum Output Voltage		1	V
Log Video Maximum Output Voltage		1.8	V
Log Video Output Rise Time	10% to 90%	4	ns
Log Video Output Fall Time	90% to 10%	18	ns
Log Video Recovery Time		26	ns
Log Video Output Slope		14	mV/dB
Log Video Output Slope Variation over Temperature	@ 10 GHz	5	$\mu\text{V}/\text{dB}^\circ\text{C}$
Log Video Propagation Delay		14	ns
Supply Current (Icc1)		80	mA
Supply Current (Icc2)	@ Pin = -30 dBm	8	mA

[1] Electrical specs and performance plots are given for single-ended operation

[2] Video output load should be 1K Ohm or higher.

For price, delivery and to place orders: Hittite Microwave Corporation, 2 Elizabeth Drive, Chelmsford, MA 01824

Phone: 978-250-3343 Fax: 978-250-3373 Order On-line at www.hittite.com

Application Support: Phone: 978-250-3343 or apps@hittite.com



SUCCESSIVE DETECTION LOG VIDEO AMPLIFIER (SDLVA), 0.1 - 20 GHz

Error Flatness vs. Input Power Over Frequency [1][2]

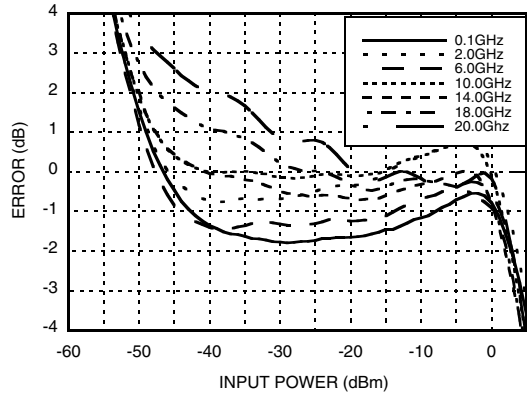

VIDEO OUT & Error vs. Input Power, Fin = 100 MHz [1]

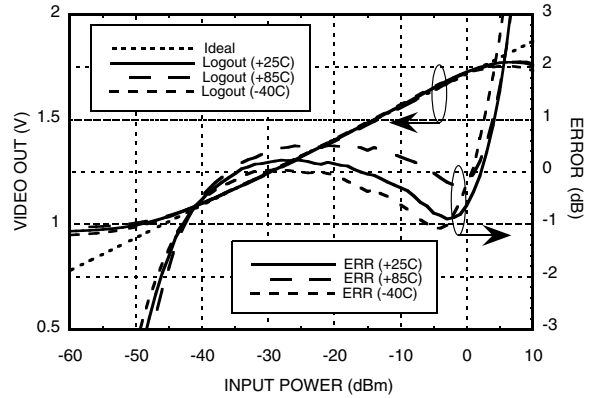

VIDEO OUT & Error vs. Input Power, Fin = 2 GHz [1]

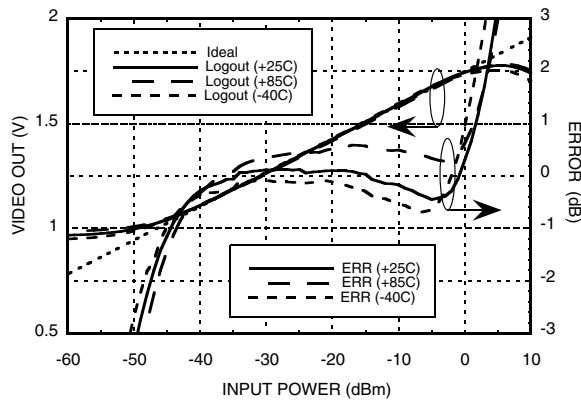

VIDEO OUT & Error vs. Input Power, Fin = 6 GHz [1]

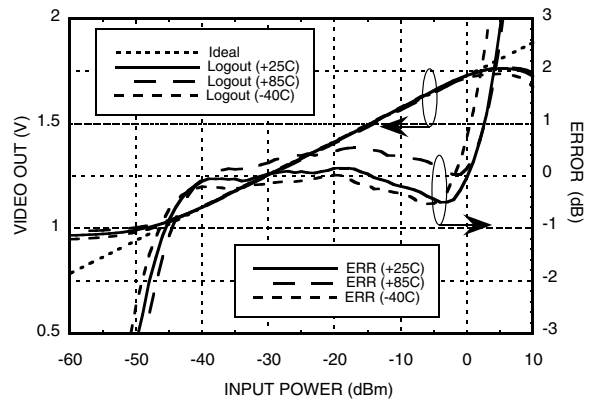

VIDEO OUT & Error vs. Input Power, Fin = 10 GHz [1]

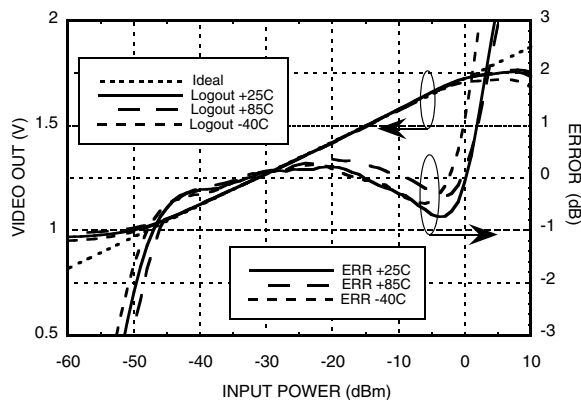

VIDEO OUT & Error vs. Input Power, Fin = 14 GHz [1]

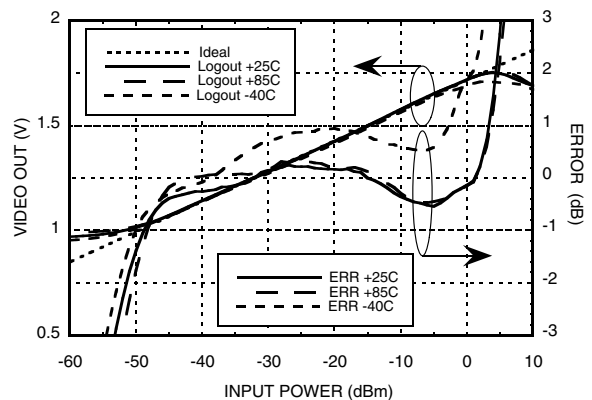

[1] Electrical Specs and performance plots are given at single-ended operation
[2] An average ideal line is used to calculate error curves.



SUCCESSIVE DETECTION LOG VIDEO AMPLIFIER (SDLVA), 0.1 - 20 GHz

POWER DETECTORS - SMT

VIDEO OUT & Error vs. Input Power, $F_{in} = 18$ GHz [1]

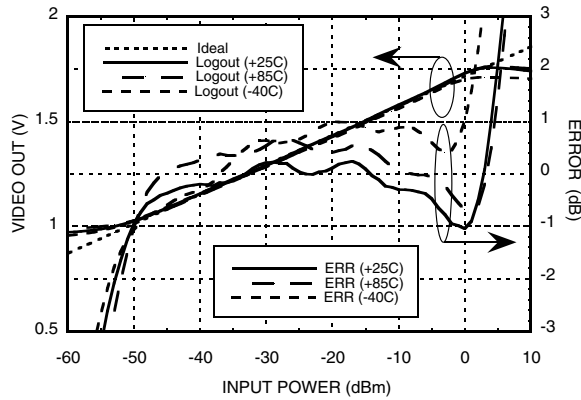

VIDEO OUT & Error vs. Input Power, $F_{in} = 20$ GHz [1]

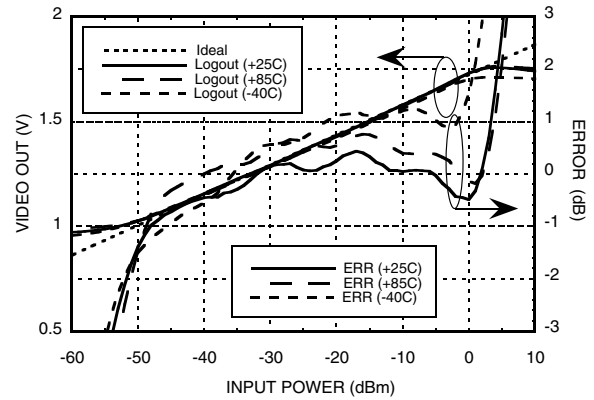

VIDEO OUT vs. Frequency Over Input Power & Temperature [1]

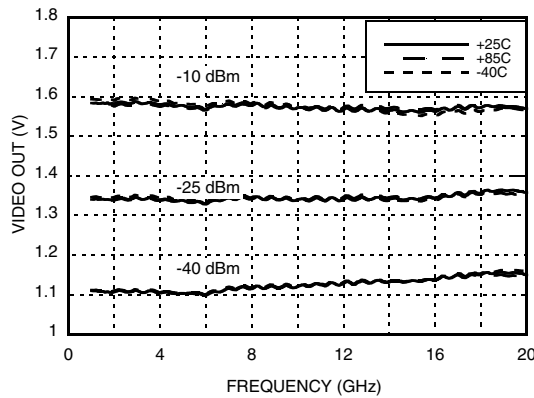

VIDEO OUT vs. Frequency Over Input Power & Bias Voltage [1]

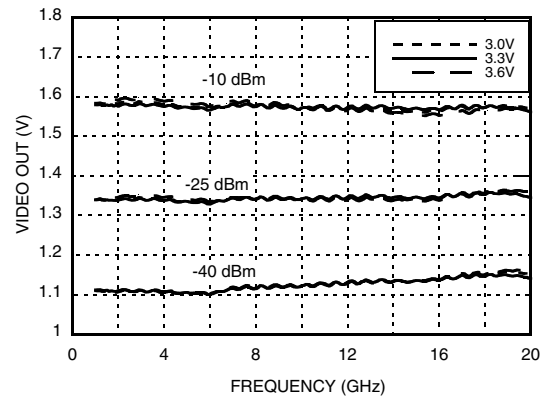

Input Return Loss vs. Frequency [1]

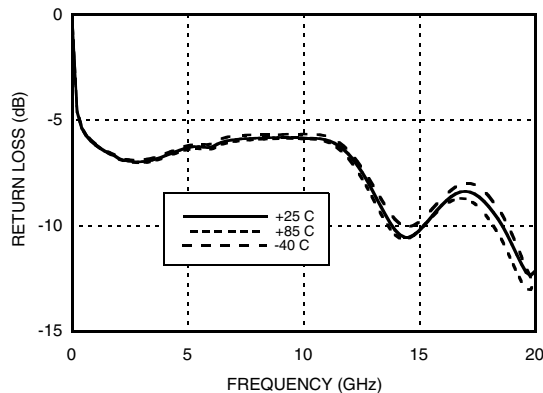

Rise Time @ Different Frequency @ 0 dBm [1]

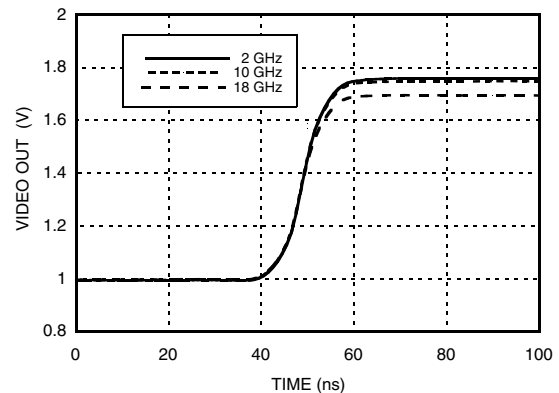

[1] Electrical Specs and performance plots are given at single-ended operation

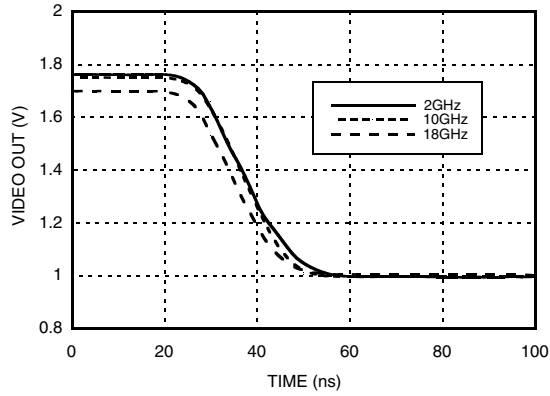
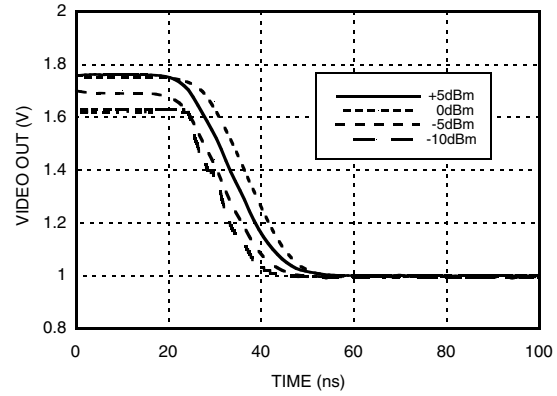
**SUCCESSIVE DETECTION LOG VIDEO
AMPLIFIER (SDLVA), 0.1 - 20 GHz**
**Fall Time @
Different Frequency @ 0 dBm [1]**

**Fall Time @
Different Power Levels @ 10 GHz [1]**

[1] Electrical Specs and performance plots are given at single-ended operation

**SUCCESSIVE DETECTION LOG VIDEO
AMPLIFIER (SDLVA), 0.1 - 20 GHz**
Absolute Maximum Ratings

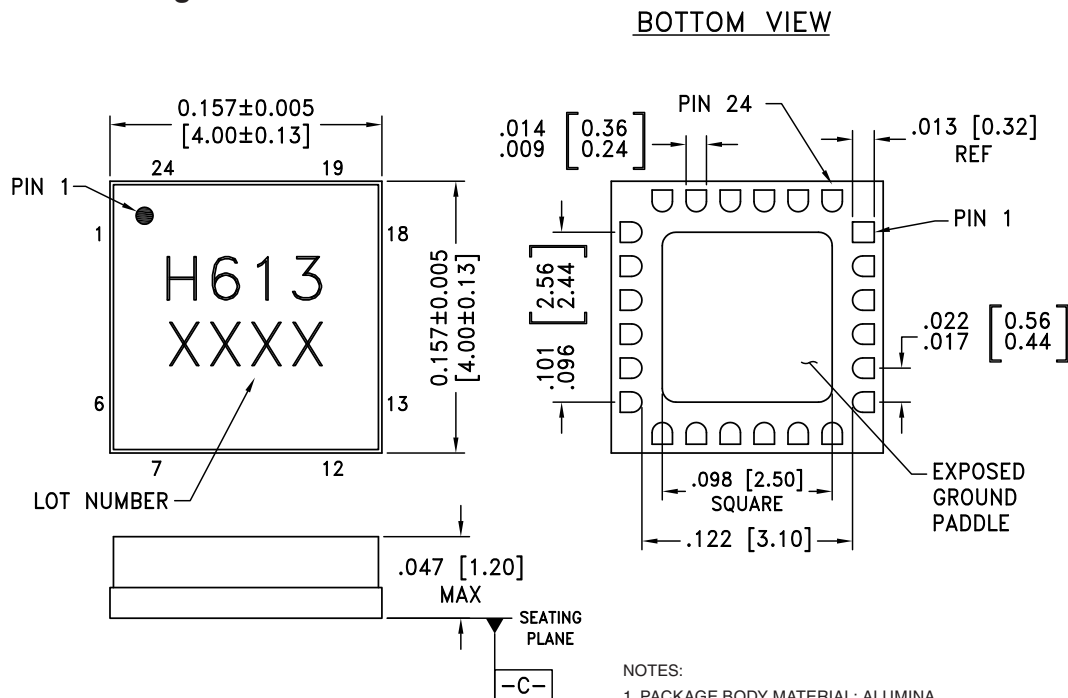
Vcc1, Vcc2	3.7 V
Input Signal Amplitude	12 dBm
Junction Temperature	125 °C
Continuous P _{diss} (T=85 °C) Derate 11.5 mW/°C above 85 °C	0.46 W
Thermal Resistance (R _{th}) (junction to package bottom)	87.1 °C/W
Storage Temperature	-65 to +150 °C
Operating Temperature	-40 to +85 °C
ESD Sensitivity (HBM)	Class 0

**ELECTROSTATIC SENSITIVE DEVICE
OBSERVE HANDLING PRECAUTIONS**
Outline Drawing

Package Information

Part Number	Package Body Material	Lead Finish	MSL Rating	Package Marking ^[2]
HMC613LC4B	Alumina, White	Gold over Nickel	MSL3 ^[1]	H613 XXXX

[1] Max peak reflow temperature of 260 °C



[2] 4-Digit lot number XXXX

For price, delivery and to place orders: Hittite Microwave Corporation, 2 Elizabeth Drive, Chelmsford, MA 01824

Phone: 978-250-3343 Fax: 978-250-3373 Order On-line at www.hittite.com

Application Support: Phone: 978-250-3343 or apps@hittite.com

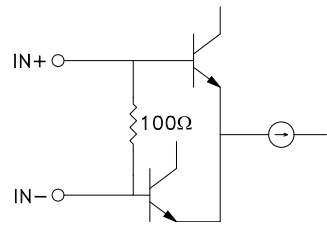
**SUCCESSIVE DETECTION LOG VIDEO
AMPLIFIER (SDLVA), 0.1 - 20 GHz**
Pin Descriptions

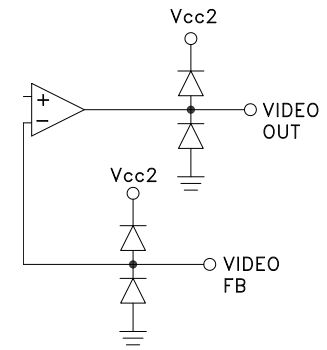
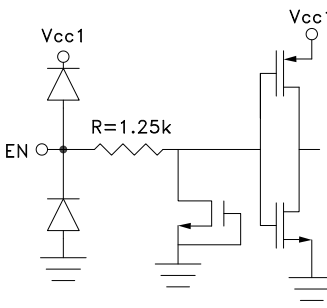
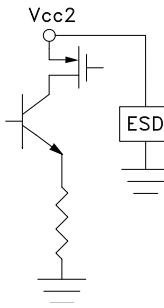
Pin Number	Function	Description	Interface Schematic
1, 2, 7, 10 - 12, 18, 19	N/C	These pins are not internally connected.	
3, 6, 13, 16, 20, 24	N/C	These pins are not connected internally. However, this product is specified with these pins connected to RF/DC Ground.	
4, 5	IN+, IN-	RF Input pins Connect RF to IN+, and AC couple IN- to ground via 50 Ohm for single ended operation.	
8, 9	GND	These pins and the exposed package bottom must be connected to a high quality RF/DC ground.	
14, 15	Video FB, Video Out	Video out and feedback. These pins should be shorted to each other (see application circuit). Video out load should be at least 1K Ohm or higher.	
17	EN	Enable pin connected to Vcc1 or Vcc2 for normal operation. Total supply current reduced to less than 3mA when EN is set to 0V.	
21	Vcc2	Bias Supply. Connect supply voltage to these pins with appropriate filtering. Connect Vcc2 with Vcc1. See application circuit. To ensure proper start-up supply rise time should be faster than 100usec	



**SUCCESSIVE DETECTION LOG VIDEO
AMPLIFIER (SDLVA), 0.1 - 20 GHz**

Pin Descriptions

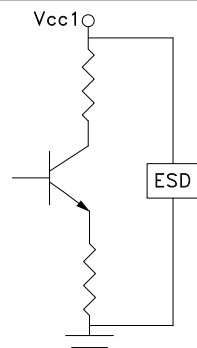
Pin Number	Function	Description	Interface Schematic
22, 23	Vcc1	<p>Bias Supply. Connect Supply Voltage to these pins with appropriate filtering. Connect Vcc2 with Vcc1. See application circuit.</p> <p>To ensure proper start-up supply rise time should be faster than 100usec</p>	



SUCCESSIVE DETECTION LOG VIDEO AMPLIFIER (SDLVA), 0.1 - 20 GHz

Application Circuit

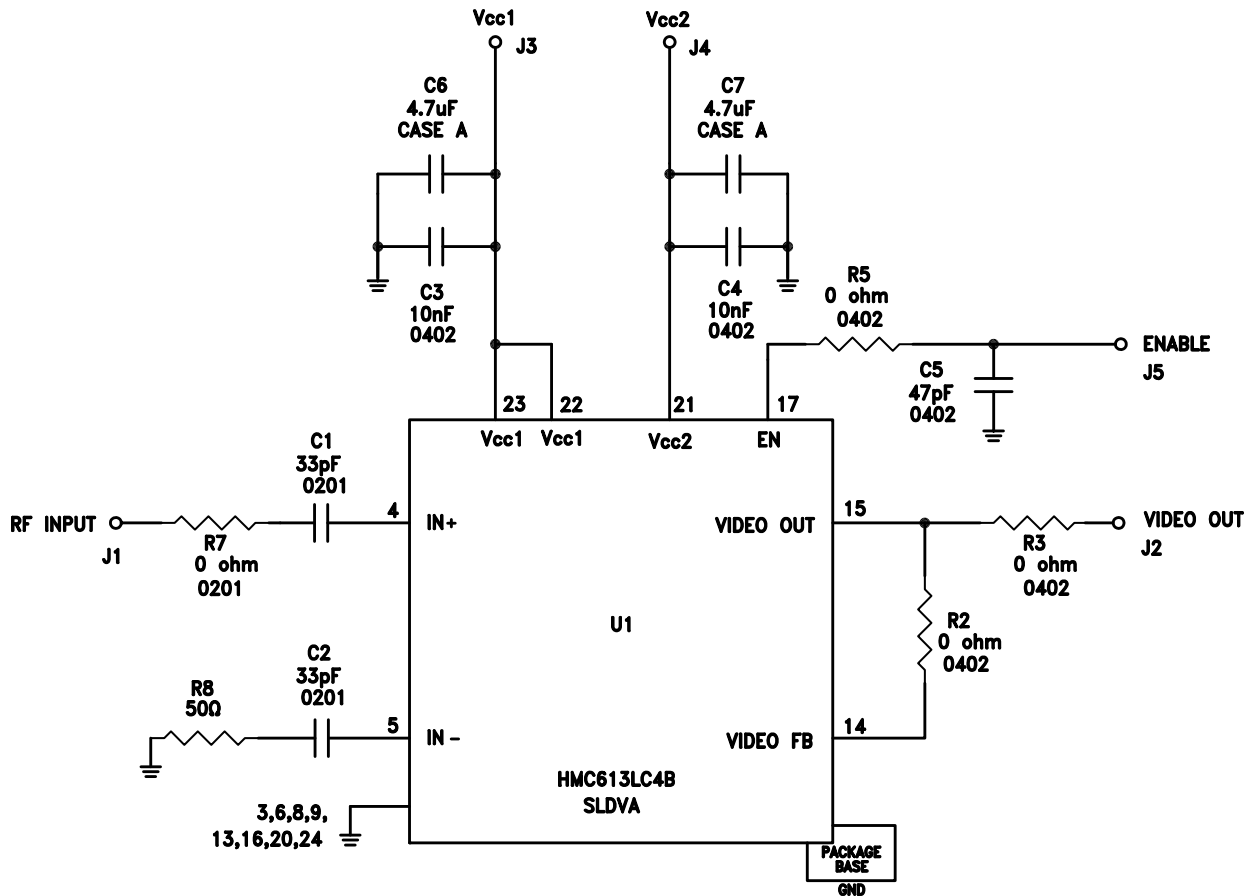

Note1: Connect Vcc2 and Vcc1 together for Nominal operation.

Note2: Video output load should be 1K Ohm or higher.

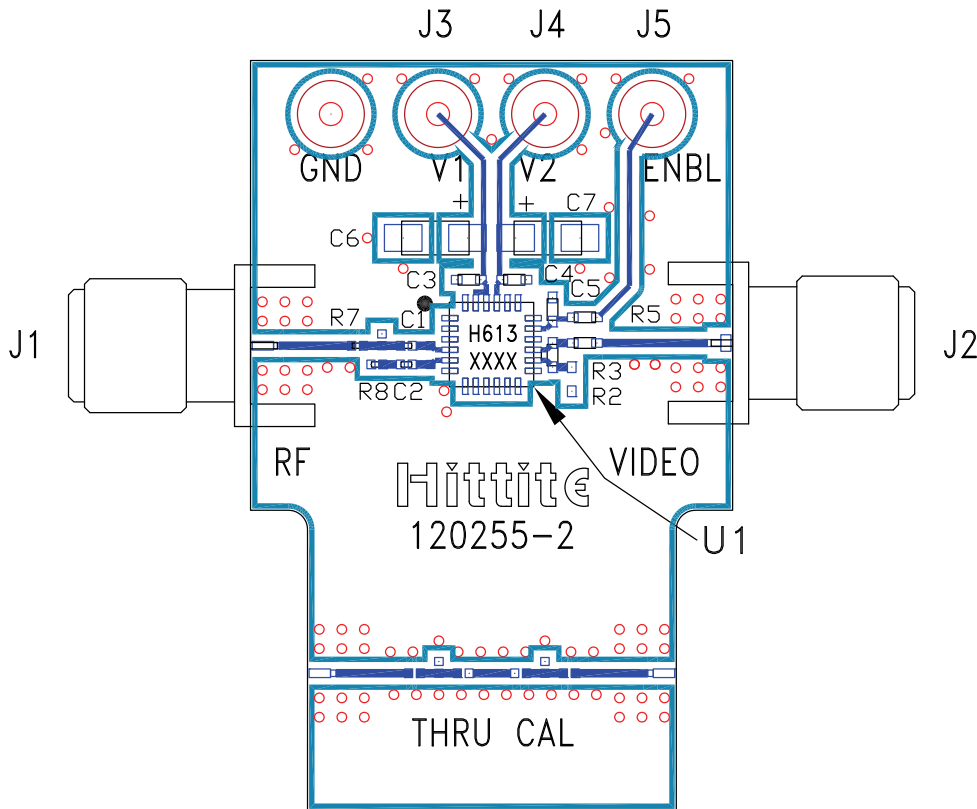
Evaluation PCB

List of Materials for Evaluation PCB 120257 [1]

Item	Description
J1	K-Type Connector
J2	SMA Connector
J3 - J5	DC Pins
C1, C2	33 pF Capacitor, 0201 Pkg.
C3, C4	10k pF Capacitor, 0402 Pkg.
C5	47 pF Capacitor, 0402 Pkg.
C6, C7	4.7 μF Capacitor, CASE A Pkg.
R2, R3, R5	0 Ohm Resistor, 0402 Pkg.
R7	0 Ohm Resistor, 0201 Pkg.
R8	49.9 Ohm Resistor, 0201 Pkg.
U1	HMC613LC4B SDLVA
PCB [2]	120255 Evaluation PCB

[1] Reference this number when ordering complete evaluation PCB

[2] Circuit Board Material: Arlon 25 FR

The circuit board used in the application should use RF circuit design techniques. Signal lines should have 50 Ohm impedance while the package ground leads and exposed paddle should be connected directly to the ground plane similar to that shown. A sufficient number of via holes should be used to connect the top and bottom ground planes. The evaluation circuit board shown is available from Hittite upon request.



**SUCCESSIVE DETECTION LOG VIDEO
AMPLIFIER (SDLVA), 0.1 - 20 GHz**

Mouser Electronics

Authorized Distributor

Click to View Pricing, Inventory, Delivery & Lifecycle Information:

[Analog Devices Inc.:](#)

[120257-HMC613LC4B](#) [HMC613LC4BTR](#) [HMC613LC4B](#) [HMC613LC4BTR-R5](#)