

Analog Devices Welcomes Hittite Microwave Corporation

NO CONTENT ON THE ATTACHED DOCUMENT HAS CHANGED



THIS PAGE INTENTIONALLY LEFT BLANK



Typical Applications

The HMC866LC3 is ideal for:

- 100 Gbps Ethernet
- 100 Gbps Long Haul
- 40 Gbps (D)QPSK Receivers
- Broadband Gain Block for Test & Measurement Equipment

Features

- Supports Data Rates up to 43 Gbps.
- Low Power Dissipation: 280 mW @ $V_{cc} = +3.3V$
- Differential Small Signal Gain: 29 dB
- Input Sensitivity: 20 mVp-p Differential
- 3-dB Bandwidth: 26.5 GHz
- Adjustable Output Voltage
Swing up to 800 mVp-p Differential
- 16 Lead 3x3mm SMT package: 9mm²

Functional Diagram

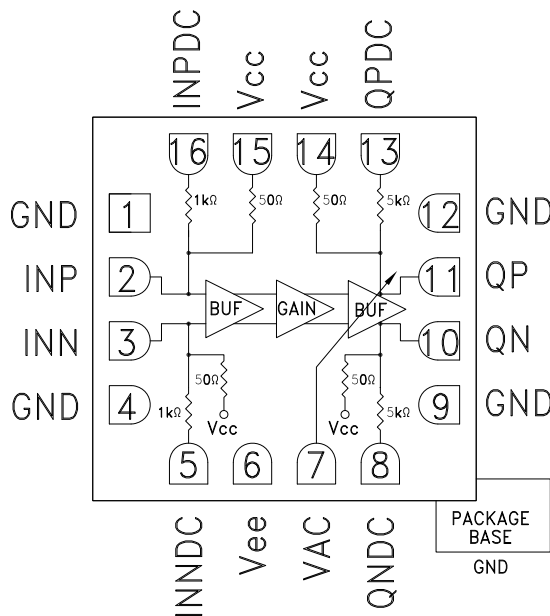

General Description

The HMC866LC3 is a Limiting Amplifier packaged in a leadless 3x3 mm ceramic surface mount package. The amplifier supports up to 43 Gbps operation and provides 29 dB of differential gain. The output voltage swing is adjustable up to 800 mVp-p differential by using the VAC analog control input and the additive RMS jitter is less than 300 fs for 32 Gbps operation. The amplifier allows external offset correction function to both inputs and outputs.

All input/output RF signals of the HMC866LC3 are terminated with 50 Ohms to +3.3V internally and may be either AC or DC coupled. The outputs of the device can be operated either differentially or single-ended. Outputs can be connected directly to 50 Ohm terminated system referenced to 3.3V, while DC blocking capacitors may be used if the terminating system is 50 Ohms to a non 3.3V level.

Electrical Specifications, $T_A = +25^\circ C$, $V_{cc} = +3.3V$, $V_{ee} = 0V$, $I_{cc} = 85mA$

Parameter	Conditions	Min.	Typ.	Max.	Units
Differential Small Signal Gain	VAC = 1.6V		29		dB
Data Rate		32			Gbps
Small Signal Bandwidth	3-dB cutoff		26.5		GHz
Input Return Loss	Up to 26.5 GHz	10			dB
Output Return Loss	Up to 26.5 GHz	10			dB
Input Sensitivity	Differential		20		mVp-p
Maximum Input Swing	Differential		1,000		mVp-p
Differential Output Swing	Adjustable by using VAC	250		800	mVpp
Rise Time [1]	20% - 80% @ 32 Gbps		13		ps

[1] Vin = Differential 50 mVp-p, fin = 32 Gbps PRBS 2²³-1 pattern



Electrical Specifications (Continued)

Parameter	Conditions	Min.	Typ.	Max.	Units
Fall Time [1]	20% - 80% @ 32 Gbps		13		ps
Additive Random Jitter [2]	Vin = 50 mVp-p (Differential)			300	fs
Input referred voltage noise	@ 15 GHz		32		nV/rtHz
	@ 25 GHz		32		nV/rtHz
VAC Input		1		1.6	V
Output P1dB	@ 16 GHz		-6		dBm
Power Supply Voltage		3.13	3.3	3.47	V
Supply Current	VAC = 1.6V		85		mA

[1] Vin = Differential 50 mVp-p, fin = 32 Gbps PRBS 2²³-1 pattern

[2] Random jitter is measured with 32 Gbps 10101... pattern

Differential Gain & Return Loss vs. Frequency [1][2]

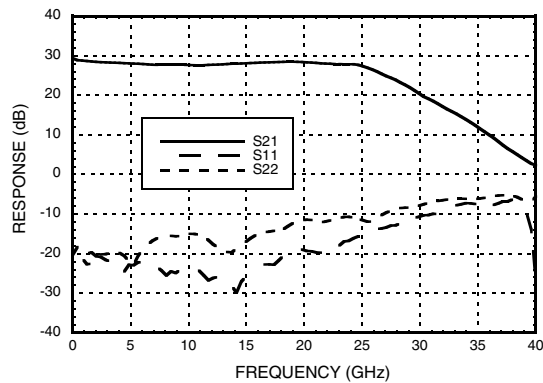

Differential Output vs. Supply Voltage [1]

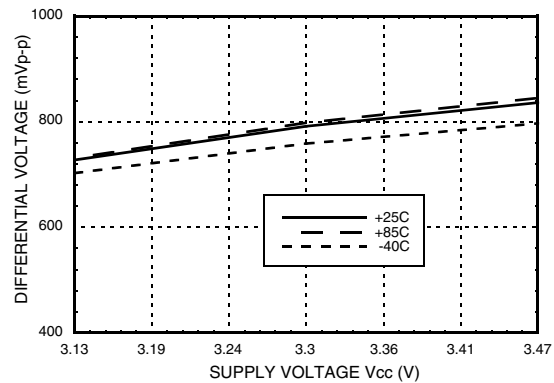

Differential Output vs. Control Voltage [2]

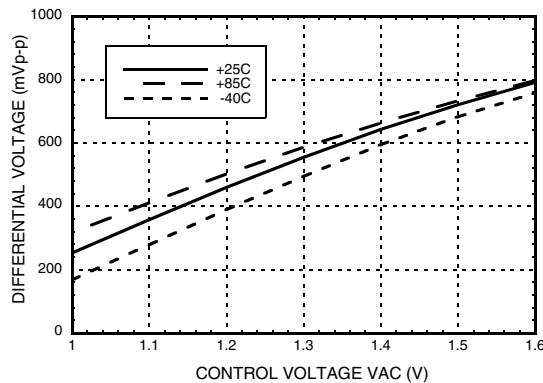

Differential Output vs. Vininput & Temperature @ 16 GHz [1][2]

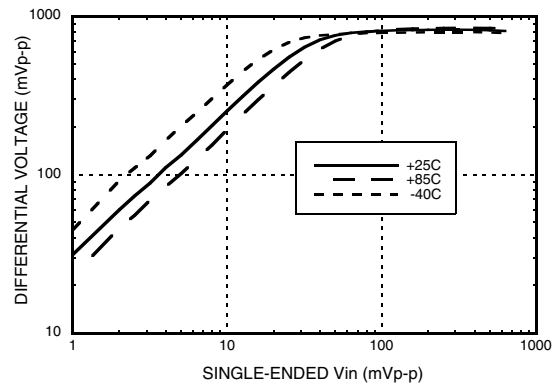

[1] VAC = 1.6V [2] Vcc = 3.3V



32 Gbps LIMITING AMPLIFIER

LIMITING AMPLIFIERS - SMT

Differential Output vs. Vininput & Supply Voltage @ 16 GHz [1]

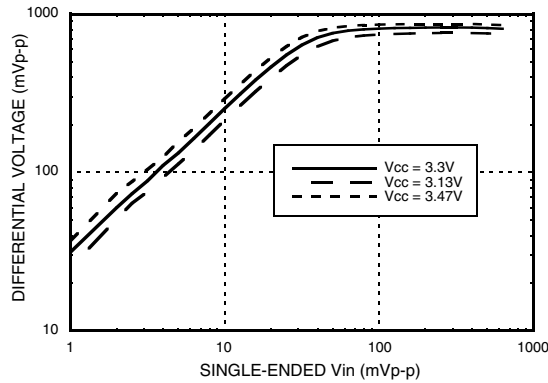

Differential Output vs. Vininput & Frequency [1] [2]

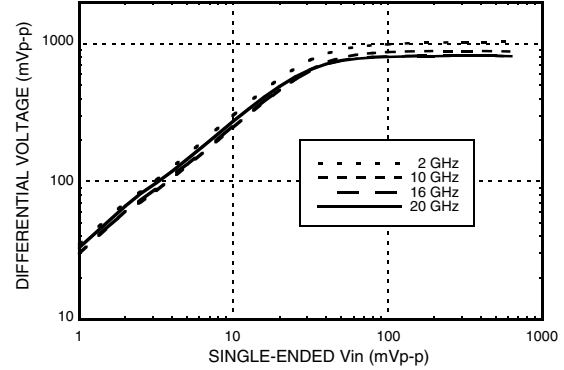

Peak to Peak Jitter vs. Supply Voltage [1][3]

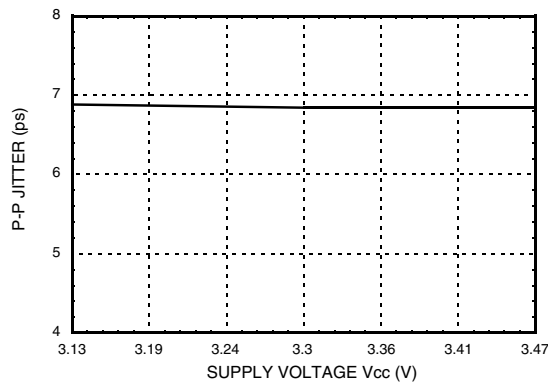

Rise & Fall Time vs. Supply Voltage [1][3]

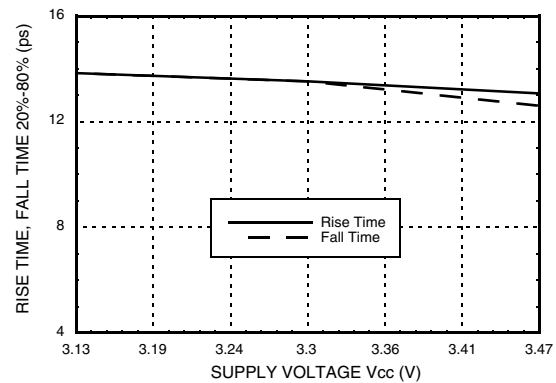

DC Current vs. Supply Voltage [1][3]

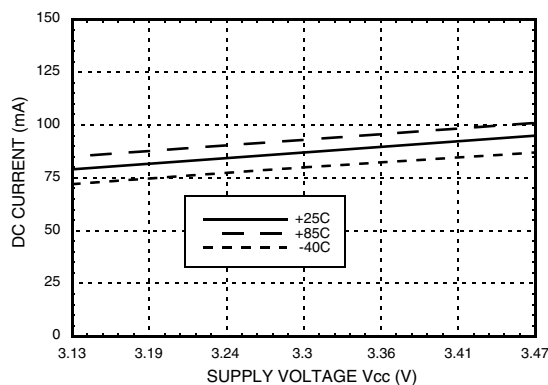

DC Current vs. Control Voltage [2][3]

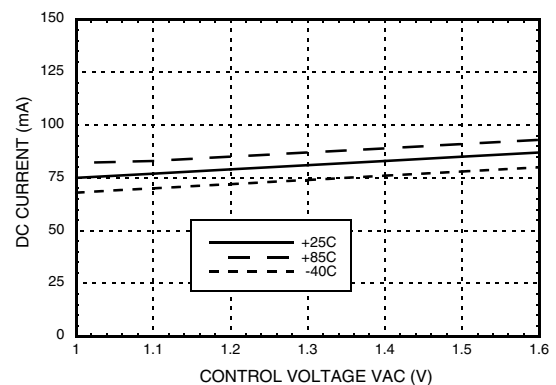

[1] VAC = 1.6V [2] Vcc = 3.3V [3] Input Data: Differential 50 mVp-p 32 Gbps NRZ PRBS 2²³-1 pattern

32 Gbps LIMITING AMPLIFIER

32 Gbps Output Eye Diagram

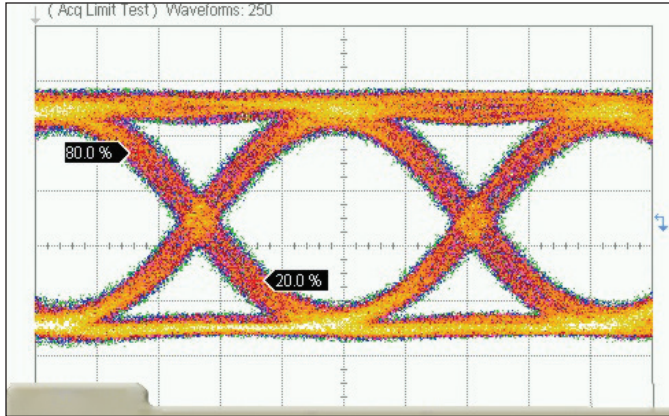

Measurements				
	Current	Minimum	Maximum	Total Meas
Eye Amp	383 mV	383 mV	384 mV	69
Jitter p-p	6.378 ps	5.289 ps	6.378 ps	69
Rise Time	13.22 ps	13.07 ps	13.53 ps	69
Fall Time	13.22 ps	10.11 ps	13.53 ps	69

Time Scale: 7 ps/div
Amplitude Scale: 100 mV/div

Test Conditions:

VAC = 1.6V, Vcc = 3.3V
Input Data: Differential 50 mVp-p 32 Gbps NRZ PRBS 2²³-1 pattern

22.5 Gbps Output Eye Diagram

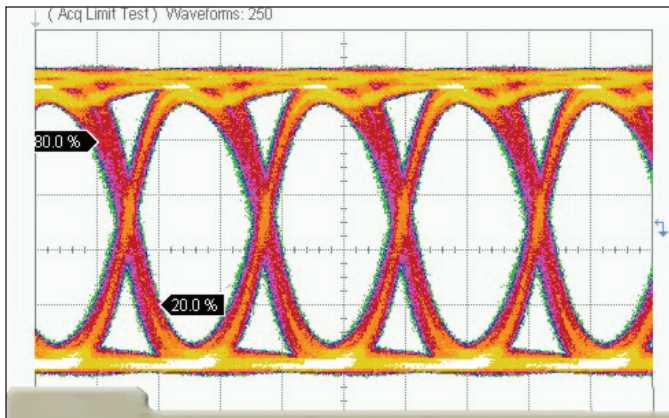

Measurements				
	Current	Minimum	Maximum	Total Meas
Eye Amp	403 mV	402 mV	404 mV	83
Jitter p-p	8.889 ps	7.111 ps	8.889 ps	83
Rise Time	13.33 ps	13.33 ps	13.78 ps	83
Fall Time	14.22 ps	13.78 ps	15.11 ps	83

Time Scale: 20 ps/div
Amplitude Scale: 81.3 mV/div

Test Conditions:

VAC = 1.6V, Vcc = 3.3V
Input Data: Differential 50 mVp-p 22.5 Gbps NRZ PRBS 2²³-1 pattern

40 Gbps Output Eye Diagram

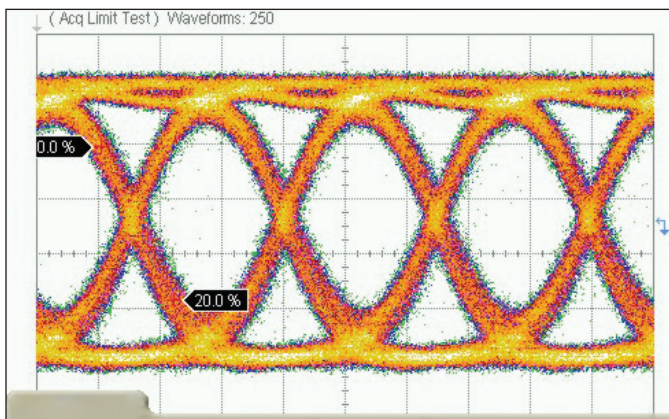

Measurements				
	Current	Minimum	Maximum	Total Meas
Eye Amp	351 mV	351 mV	352 mV	62
Jitter p-p	6.222 ps	5.333 ps	6.222 ps	62
Rise Time	11.56 ps	11.33 ps	11.56 ps	62
Fall Time	11.78 ps	11.56 ps	12.00 ps	62

Time Scale: 10 ps/div
Amplitude Scale: 80.1 mV/div

Test Conditions:

VAC = 1.6V, Vcc = 3.3V
Input Data: Differential 80 mVp-p 40 Gbps NRZ PRBS 2²³-1 pattern

**Absolute Maximum Ratings**

Power Supply Voltage (Vcc)	-0.5V to +3.6V
Input Voltage	(Vcc -1.3V) to (Vcc +0.5)
Output Voltage	(Vcc -1V) to (Vcc +0.5)
Output Amplitude Control Voltage (VAC)	-0.5V to +2.5V
Junction Temperature	125 °C
Continuous P _{diss} (T = 85°C) (Derate 12.22 mW/°C above 85°C)	0.49W
Thermal Resistance (R _{th}) (junction to ground paddle)	81.83 °C/W
Storage Temperature	-65 to 125 °C
Operating Temperature	-40 to +85 °C
ESD Sensitivity (HBM)	Class 1A

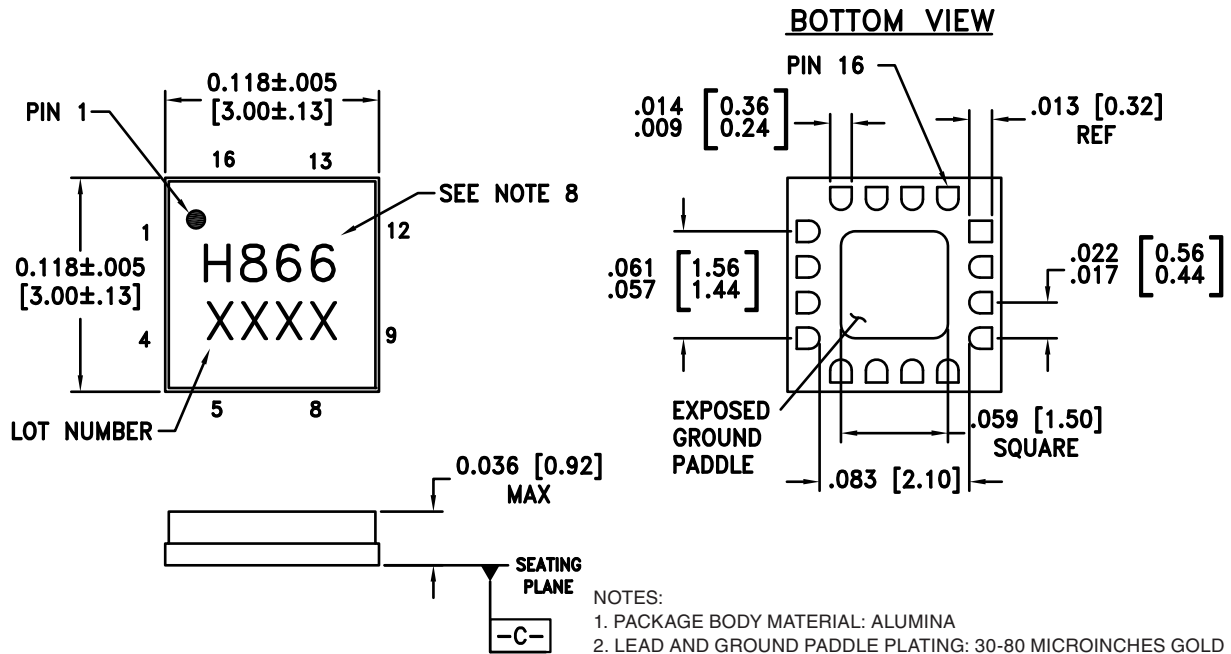

**ELECTROSTATIC SENSITIVE DEVICE
OBSERVE HANDLING PRECAUTIONS**

Outline Drawing

- NOTES:
1. PACKAGE BODY MATERIAL: ALUMINA
 2. LEAD AND GROUND PADDLE PLATING: 30-80 MICROINCHES GOLD OVER 50 MICROINCHES MINIMUM NICKEL.
 3. DIMENSIONS ARE IN INCHES [MILLIMETERS].
 4. LEAD SPACING TOLERANCE IS NON-CUMULATIVE.
 5. CHARACTERS TO BE BLACK INK MARKED WITH .018" MIN TO .030" MAX HEIGHT REQUIREMENTS. UTILIZE MAXIMUM CHARACTER HEIGHT BASED ON LID DIMENSIONS AND BEST FIT. LOCATE APPROX. AS SHOWN.
 6. PACKAGE WARP SHALL NOT EXCEED 0.05MM DATUM -C-
 7. ALL GROUND LEADS AND GROUND PADDLE MUST BE SOLDERED TO PCB RF GROUND.
 8. PART NUMBER MARKING CONFIGURATION:
 HXXX FOR 3 DIGIT HMC #'S (IE. H123)
 XXXX FOR 4 DIGIT HMC #'S (IE. 1234)

Package Information

Part Number	Package Body Material	Lead Finish	MSL Rating	Package Marking ^[2]
HMC866LC3	Alumina, White	Gold over Nickel	MSL3 ^[1]	H866 XXXX

[1] Max peak reflow temperature of 260 °C

[2] 4-Digit lot number XXXX

Pin Descriptions

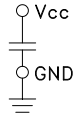
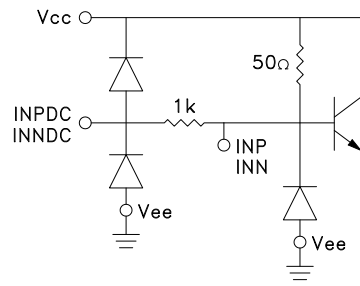
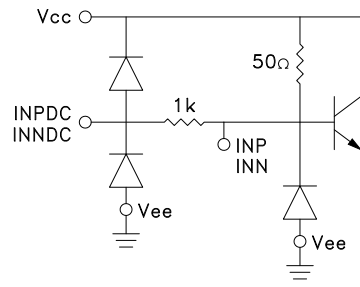
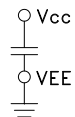
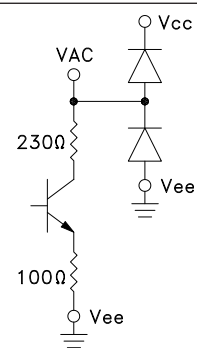
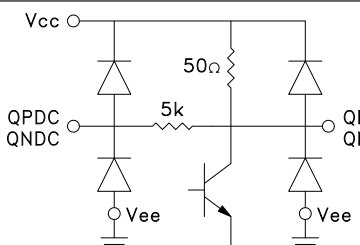
Pin Number	Function	Description	Interface Schematic
1, 4, 9, 12	GND	Signal grounds should be connected to 0V.	
2, 3	INP, INN	Data Inputs	
5, 16	INNDC, INPDC	DC Offset Inputs	
6	Vee	Supply grounds should be connected to 0V.	
7	VAC	Output amplitude control voltage	
8, 13	QNDC, QPDC	DC monitor outputs.	

Pin Descriptions (Continued)

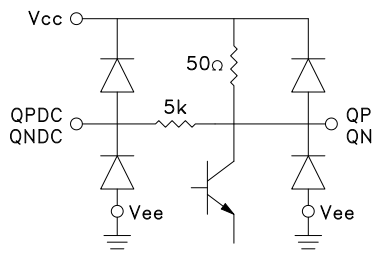
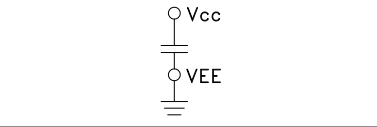
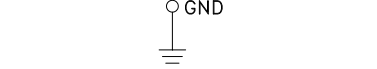
Pin Number	Function	Description	Interface Schematic
10, 11	QN, QP	Data outputs.	
14, 15	Vcc	Positive Supply	
Ground Paddle	GND	Ground paddle must be connected to DC ground.	



Evaluation PCB

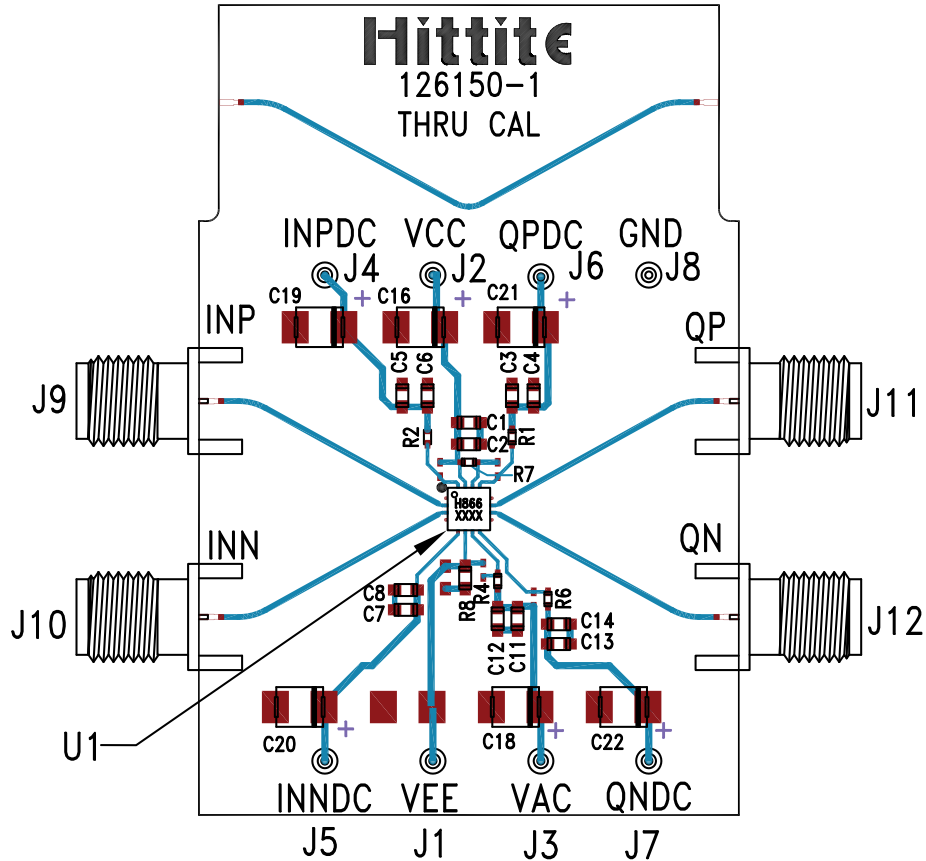

List of Materials for Evaluation PCB EVAL01-HMC866LC3 [1]

Item	Description
J1 - J8	DC Pin
J9 - J12	K-type Connector
C1, C3, C5, C7, C11, C13	0.1 μ F Capacitor, 0603 Pkg.
C2, C4, C6, C8, C12, C14	1000 pF Capacitor, 0603 Pkg.
C16, C18, C22	4.7 μ F Capacitor, Tantalum
R1, R2, R4, R6, R7	0 Ohm Resistor, 0402 Pkg.
R8	0 Ohm Resistor, 0603 Pkg.
U1	HMC866LC3C Limiting Amplifier
PCB [2]	126150 Evaluation PCB

[1] Reference this number when ordering complete evaluation PCB

[2] Circuit Board Material: Arlon 25FR or Rogers 4350

The circuit board used in the application should use RF circuit design techniques. Signal lines should have 50 Ohm impedance while the package ground leads and exposed paddle should be connected directly to the ground plane similar to that shown. A sufficient number of via holes should be used to connect the top and bottom ground planes. The evaluation circuit board shown is available from Hittite upon request.



Application Circuit

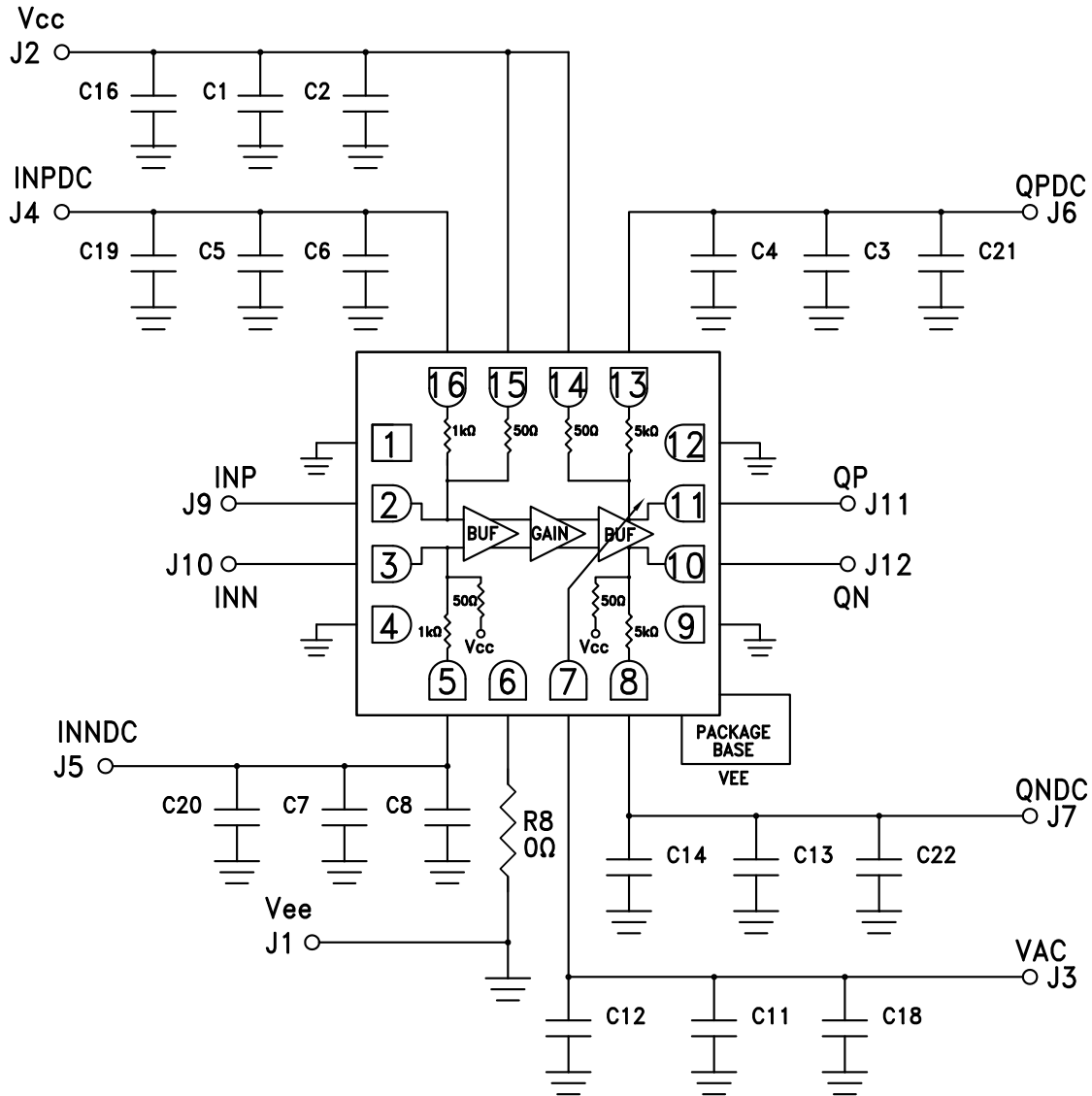

Component	Value
C2, C4, C6, C8, C12, C14	1 nF
C1, C3, C5, C7, C11, C13	0.1 μ F
C16, C18 - C22	4.7 μ F



Application Information

Setting the output swing using external resistor R_c

The HMC866LC3 features output swing level adjustment by using VAC pin. Output swing can be adjusted to the desired level by applying a DC voltage to VAC pin. Differential output swing vs. control voltage relationship is given in the plot below.

Differential Output vs. Control Voltage

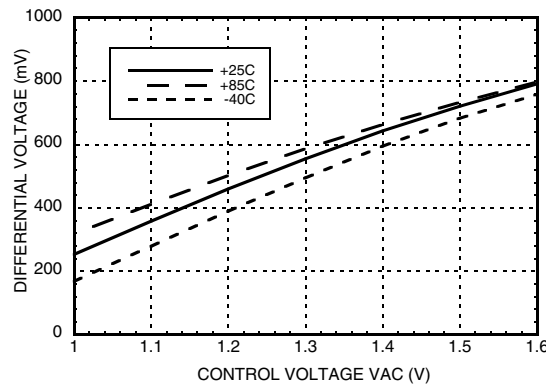

In order to adjust the DC voltage on VAC pin a resistor, R_c , should be connected between VAC pin and VCC as shown in the figure below.

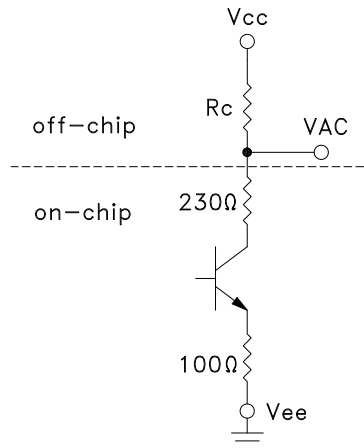

The value of the resistor can be chosen using the following equation as a function of VAC. VAC DC voltage value can be chosen by using the plot given above.

$$R_c = \frac{330(V_{cc} - V_{AC})}{V_{AC} - 0.86}$$



Mouser Electronics

Authorized Distributor

Click to View Pricing, Inventory, Delivery & Lifecycle Information:

[Analog Devices Inc.:](#)

[HMC866LC3](#) [EVAL01-HMC866LC3](#) [HMC866LC3TR](#) [HMC866LC3TR-R5](#)