

COMPLEMENTARY PAIR ENHANCEMENT MODE MOSFET

Product Summary

Device	V _{(BR)DSS}	R _{DS(ON)} max	Package	I _D max T _A = +25°C
Q1	30V	55mΩ @ V _{GS} = 10V	TSOT26	3.8A
		65mΩ @ V _{GS} = 4.5V	TSOT26	3.6A
Q2	-30V	110mΩ @ V _{GS} = -10V	TSOT26	-2.5A
		142mΩ @ V _{GS} = -4.5V	TSOT26	-2.1A

Features

- Complementary MOSFET
- Low On-Resistance
- Low Input Capacitance
- Fast Switching Speed
- **Totally Lead-Free & Fully RoHS Compliant (Notes 1 & 2)**
- **Halogen and Antimony Free. "Green" Device (Note 3)**
- **Qualified to AEC-Q101 Standards for High Reliability**

Description

This MOSFET has been designed to minimize the on-state resistance (R_{DS(ON)}) and yet maintain superior switching performance, making it ideal for high efficiency power management applications.

Applications

- Backlighting
- Power Management Functions
- DC-DC Converters

Mechanical Data

- Case: TSOT26
- Case Material: Molded Plastic, "Green" Molding Compound. UL Flammability Classification Rating 94V-0
- Moisture Sensitivity: Level 1 per J-STD-020
- Terminal Connections Indicator: See diagram
- Terminals: Finish — NiPdAu over Copper Leadframe. Solderable per MIL-STD-202, Method 208 (e4)
- Weight: 0.008 grams (approximate)

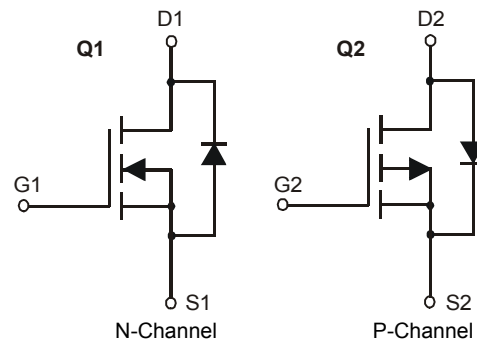
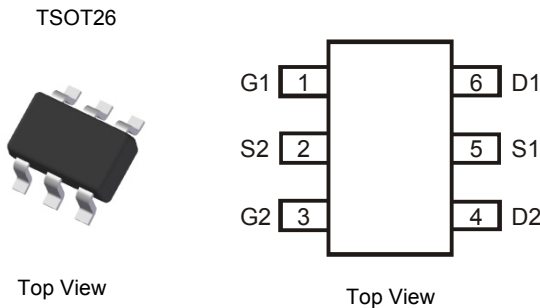

Device Schematic

Ordering Information (Note 4)

Part Number	Case	Packaging
DMG6601LVT-7	TSOT26	3K/Tape & Reel

- Notes:
1. No purposely added lead. Fully EU Directive 2002/95/EC (RoHS) & 2011/65/EU (RoHS 2) compliant.
 2. See http://www.diodes.com/quality/lead_free.html for more information about Diodes Incorporated's definitions of Halogen- and Antimony-free, "Green" and Lead-free.
 3. Halogen- and Antimony-free "Green" products are defined as those which contain <900ppm bromine, <900ppm chlorine (<1500ppm total Br + Cl) and <1000ppm antimony compounds.
 4. For packaging details, go to our website at <http://www.diodes.com/products/packages.html>

Marking Information

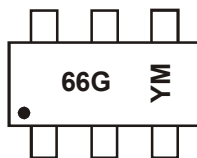

66G = Product Type Marking Code
 YM = Date Code Marking
 Y = Year (ex: X = 2010)
 M = Month (ex: 9 = September)

Date Code Key

Year	2011	2012	2013	2014	2015	2016	2017
Code	Y	Z	A	B	C	D	E

Month	Jan	Feb	Mar	Apr	May	Jun	Jul	Aug	Sep	Oct	Nov	Dec
Code	1	2	3	4	5	6	7	8	9	O	N	D

Maximum Ratings - Q1 and Q2 (@T_A = +25°C, unless otherwise specified.)

Characteristic	Symbol	Q1	Q2	Units	
Drain-Source Voltage	V _{DSS}	30	-30	V	
Gate-Source Voltage	V _{GSS}	±12	±12	V	
Continuous Drain Current (Note 6) V _{GS} = 10V	Steady State	T _A = +25°C T _A = +70°C	3.8 3.0	-2.5 -2	A
	t < 10s	T _A = +25°C T _A = +70°C	4.5 3.4	-3 -2.3	A
Maximum Body Diode Forward Current (Note 6)	I _S	1.5	-1.5	A	
Pulsed Drain Current (Note 6)	I _{DM}	20	-15	A	

Thermal Characteristics (@T_A = +25°C, unless otherwise specified.)

Characteristic	Symbol	Value	Units
Total Power Dissipation (Note 5)	P _D	T _A = +25°C	0.85
		T _A = +70°C	0.54
Thermal Resistance, Junction to Ambient (Note 5)	R _{θJA}	Steady state	147
		t < 10s	103
Total Power Dissipation (Note 6)	P _D	T _A = +25°C	1.3
		T _A = +70°C	0.83
Thermal Resistance, Junction to Ambient (Note 6)	R _{θJA}	Steady state	96
		t < 10s	67
Thermal Resistance, Junction to Case (Note 6)	R _{θJC}	36	
Operating and Storage Temperature Range	T _J , T _{STG}	-55 to +150	°C

Electrical Characteristics - Q1 (@T_A = +25°C, unless otherwise specified.)

Characteristic	Symbol	Min	Typ	Max	Unit	Test Condition
OFF CHARACTERISTICS (Note 7)						
Drain-Source Breakdown Voltage	BV _{DSS}	30	-	-	V	V _{GS} = 0V, I _D = 250μA
Zero Gate Voltage Drain Current @T _J = +25°C	I _{DSS}	-	-	1	μA	V _{DS} = 30V, V _{GS} = 0V
Gate-Source Leakage	I _{GSS}	-	-	±100	nA	V _{GS} = ±12V, V _{DS} = 0V
ON CHARACTERISTICS (Note 7)						
Gate Threshold Voltage	V _{GS(th)}	0.5	1	1.5	V	V _{DS} = V _{GS} , I _D = 250μA
Static Drain-Source On-Resistance	R _{DS(on)}	-	34	55	mΩ	V _{GS} = 10V, I _D = 3.4A
		-	38	65		V _{GS} = 4.5V, I _D = 3A
		-	49	85		V _{GS} = 2.5V, I _D = 2A
Forward Transfer Admittance	Y _{fs}	-	6	-	S	V _{DS} = 5V, I _D = 3.4A
Diode Forward Voltage (Note 7)	V _{SD}	-	0.75	1.0	V	V _{GS} = 0V, I _S = 1A
DYNAMIC CHARACTERISTICS (Note 8)						
Input Capacitance	C _{iss}	-	422	-	pF	V _{DS} = 15V, V _{GS} = 0V, f = 1.0MHz
Output Capacitance	C _{oss}	-	41	-	pF	
Reverse Transfer Capacitance	C _{rss}	-	39	-	pF	
Gate resistance	R _g	-	1.26	-	Ω	V _{DS} = 0V, V _{GS} = 0V, f = 1.0MHz
Total Gate Charge (V _{GS} = 4.5V)	Q _g	-	5.4	-	nC	V _{GS} = 10V, V _{DS} = 15V, I _D = 3.1A
Total Gate Charge (V _{GS} = 10V)	Q _g	-	12.3	-	nC	
Gate-Source Charge	Q _{gs}	-	0.8	-	nC	
Gate-Drain Charge	Q _{gd}	-	1.2	-	nC	
Turn-On Delay Time	t _{D(on)}	-	1.6	-	ns	V _{DS} = 15V, V _{GS} = 10V, R _L = 4.7Ω, R _G = 3Ω,
Turn-On Rise Time	t _r	-	7.4	-	ns	
Turn-Off Delay Time	t _{D(off)}	-	31.2	-	ns	
Turn-Off Fall Time	t _f	-	15.6	-	ns	

- Notes:
- Device mounted on FR-4 substrate PC board, 2oz copper, with minimum recommended pad layout
 - Device mounted on FR-4 substrate PC board, 2oz copper, with thermal vias to bottom layer 1 inch square copper plate
 - Short duration pulse test used to minimize self-heating effect.
 - Guaranteed by design. Not subject to product testing.

Electrical Characteristics - Q2 (@T_A = +25°C, unless otherwise specified.)

Characteristic	Symbol	Min	Typ	Max	Unit	Test Condition
OFF CHARACTERISTICS (Note 7)						
Drain-Source Breakdown Voltage	BV _{DSS}	-30	-	-	V	V _{GS} = 0V, I _D = -250μA
Zero Gate Voltage Drain Current @T _J = +25°C	I _{DSS}	-	-	-1	μA	V _{DS} = -30V, V _{GS} = 0V
Gate-Source Leakage	I _{GSS}	-	-	±100	nA	V _{GS} = ±12V, V _{DS} = 0V
ON CHARACTERISTICS (Note 7)						
Gate Threshold Voltage	V _{GS(th)}	-0.4	-0.8	-1.2	V	V _{DS} = V _{GS} , I _D = -250μA
Static Drain-Source On-Resistance	R _{DS(on)}	-	70	110	mΩ	V _{GS} = -10V, I _D = -2.3A
		-	81	142		V _{GS} = -4.5V, I _D = -2A
		-	105	190		V _{GS} = -2.5V, I _D = -1A
		-	-	-		-
Forward Transfer Admittance	Y _{fs}	-	5.3	-	S	V _{DS} = -5V, I _D = -2.3A
Diode Forward Voltage (Note 7)	V _{SD}	-	-0.8	-1.0	V	V _{GS} = 0V, I _S = -1A
DYNAMIC CHARACTERISTICS (Note 8)						
Input Capacitance	C _{iss}	-	541	-	pF	V _{DS} = -15V, V _{GS} = 0V, f = 1.0MHz
Output Capacitance	C _{oss}	-	46	-	pF	
Reverse Transfer Capacitance	C _{rss}	-	43	-	pF	V _{DS} = 0V, V _{GS} = 0V, f = 1.0MHz
Gate resistance	R _g	-	16.9	-	Ω	
Total Gate Charge (V _{GS} = -4.5V)	Q _g	-	6.5	-	nC	V _{GS} = -10V, V _{DS} = -15V, I _D = -2.3A
Total Gate Charge (V _{GS} = -10V)	Q _g	-	13.8	-	nC	
Gate-Source Charge	Q _{gs}	-	1.0	-	nC	
Gate-Drain Charge	Q _{gd}	-	1.6	-	nC	
Turn-On Delay Time	t _{D(on)}	-	1.7	-	ns	V _{DS} = -15V, V _{GS} = -10V, R _L = 6Ω, R _G = 3Ω,
Turn-On Rise Time	t _r	-	4.6	-	ns	
Turn-Off Delay Time	t _{D(off)}	-	18.3	-	ns	
Turn-Off Fall Time	t _f	-	2.2	-	ns	

Notes: 7. Short duration pulse test used to minimize self-heating effect.
8. Guaranteed by design. Not subject to product testing.

N Channel - Q1

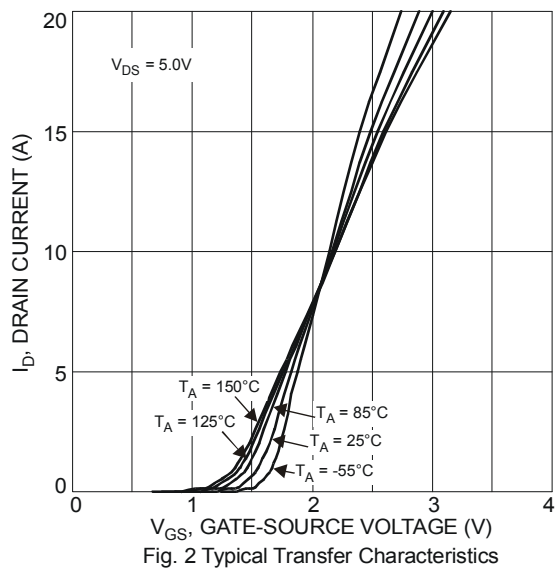
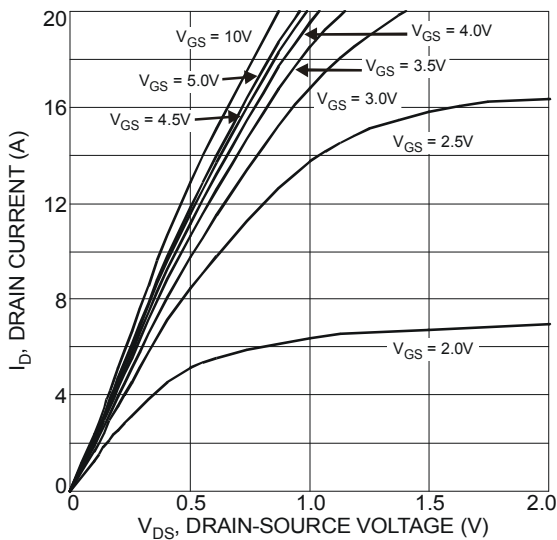

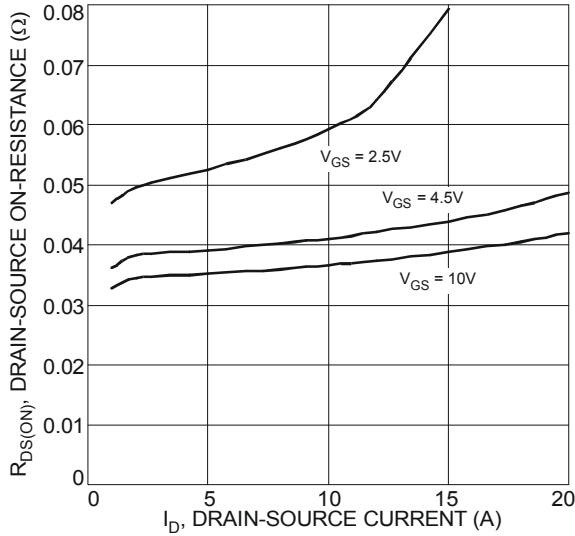

Fig. 3 Typical On-Resistance vs. Drain Current and Gate Voltage

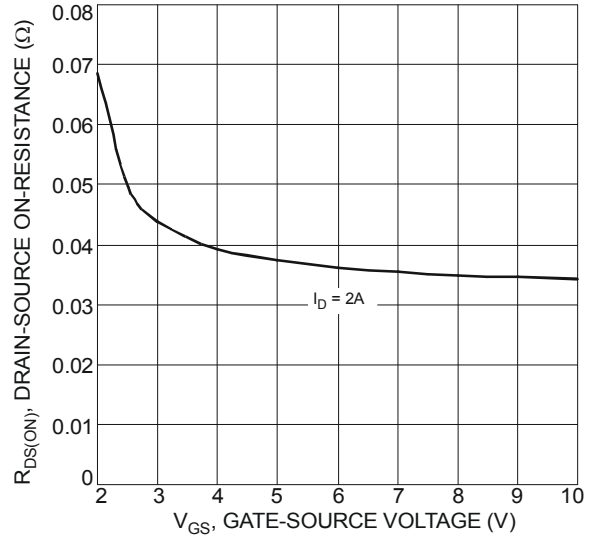

Fig. 4 Typical Drain-Source On-Resistance vs. Gate-Source Voltage

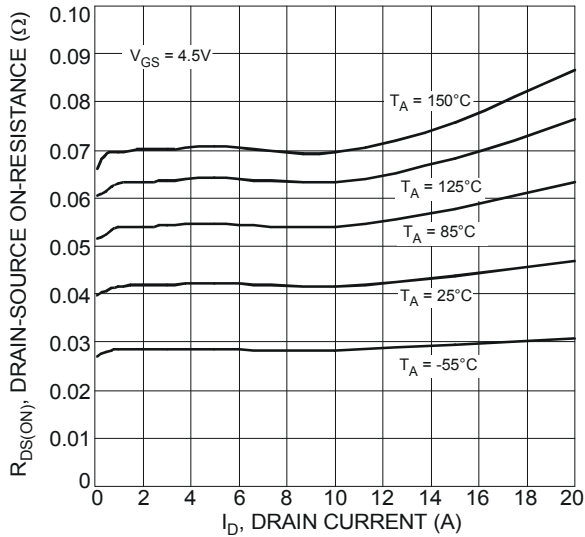

Fig. 5 Typical On-Resistance vs. Drain Current and Temperature

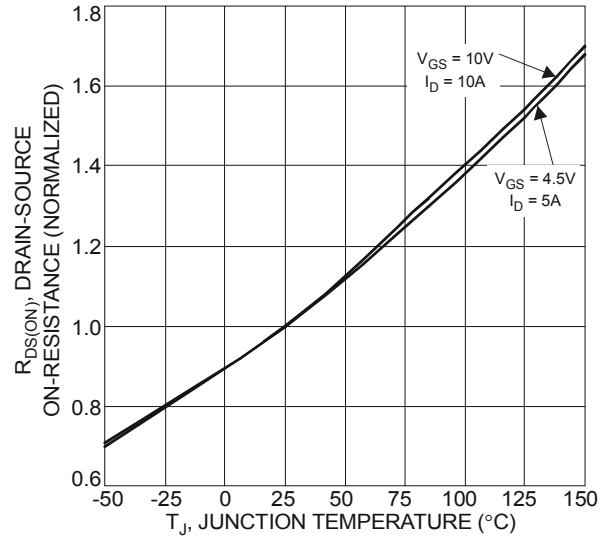

Fig. 6 On-Resistance Variation with Temperature

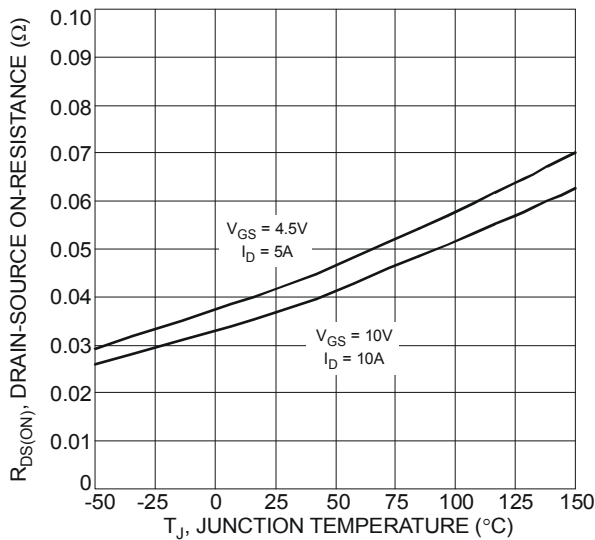

Fig. 7 On-Resistance Variation with Temperature

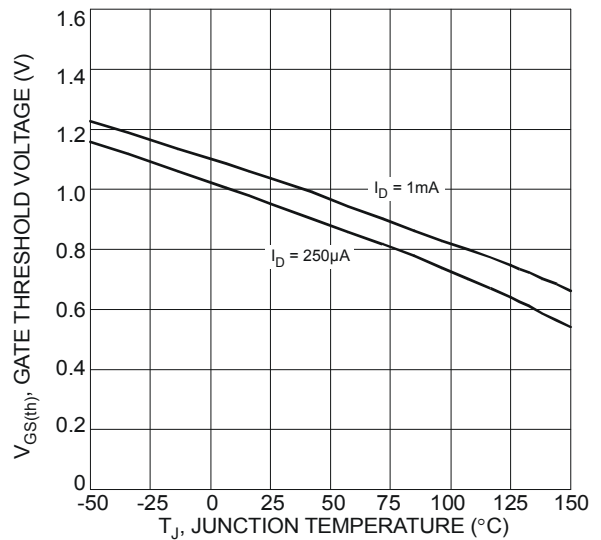

Fig. 8 Gate Threshold Variation vs. Ambient Temperature

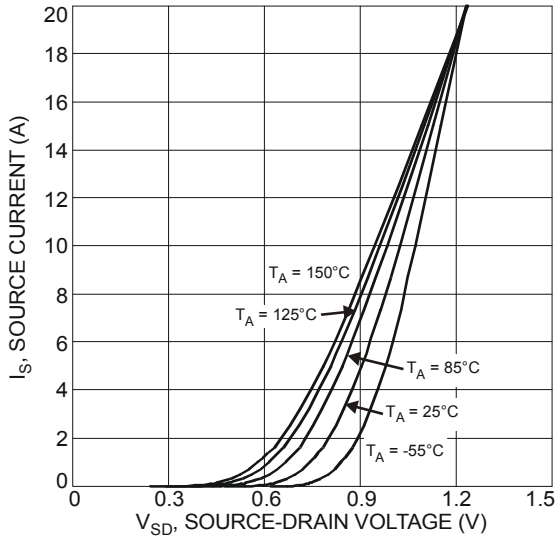

Fig. 9 Diode Forward Voltage vs. Current

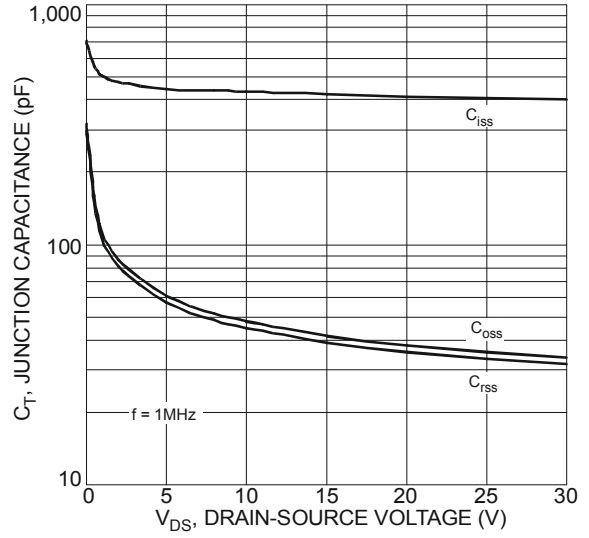

Fig. 10 Typical Junction Capacitance

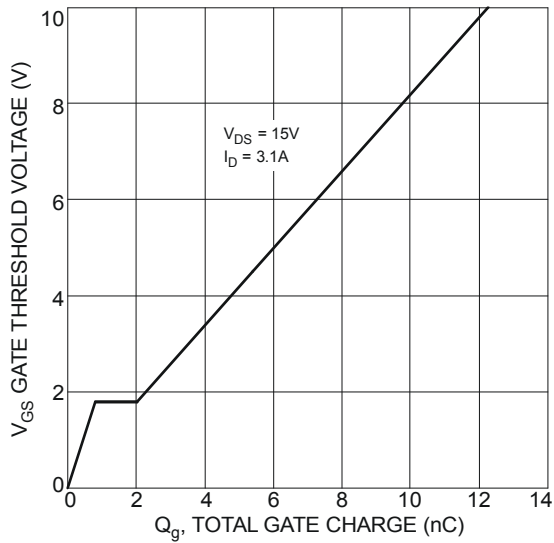

Fig. 11 Gate Charge

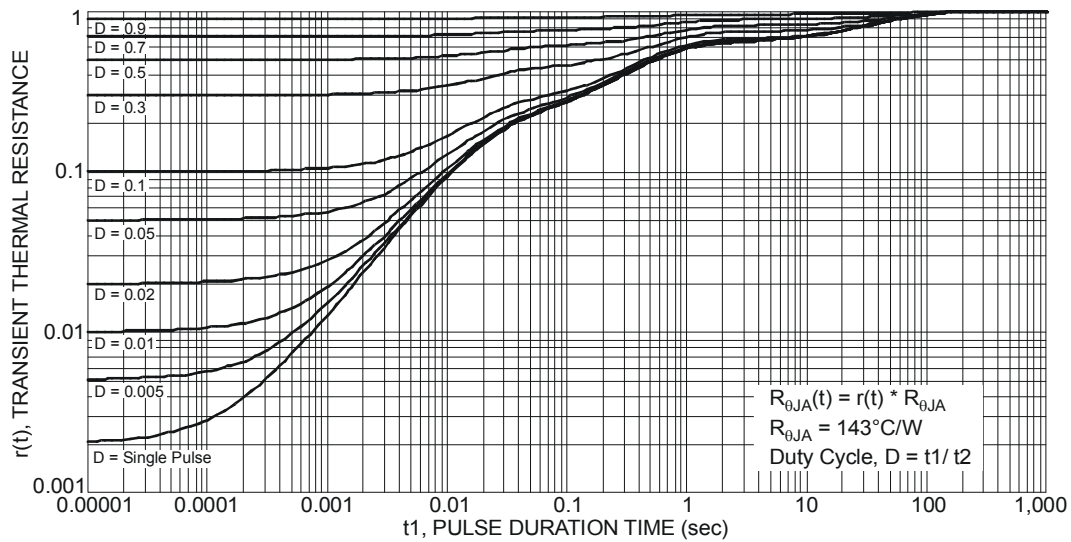

Fig. 12 Transient Thermal Resistance

$$R_{\theta JA}(t) = r(t) * R_{\theta JA}$$

$$R_{\theta JA} = 143^{\circ}\text{C/W}$$

$$\text{Duty Cycle, } D = t_1 / t_2$$

P Channel - Q2

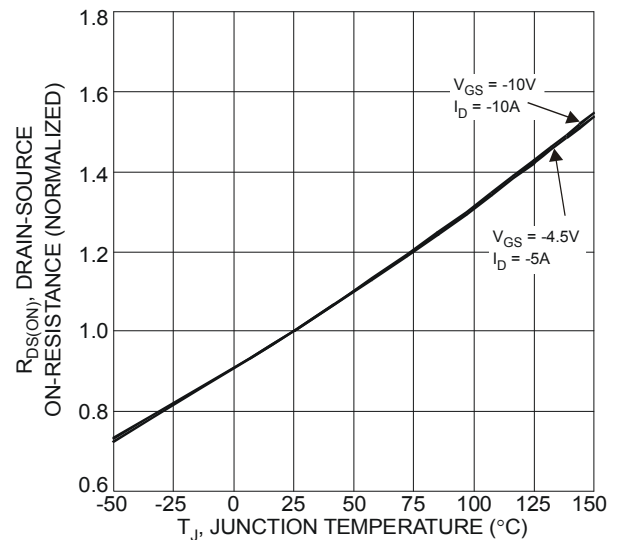
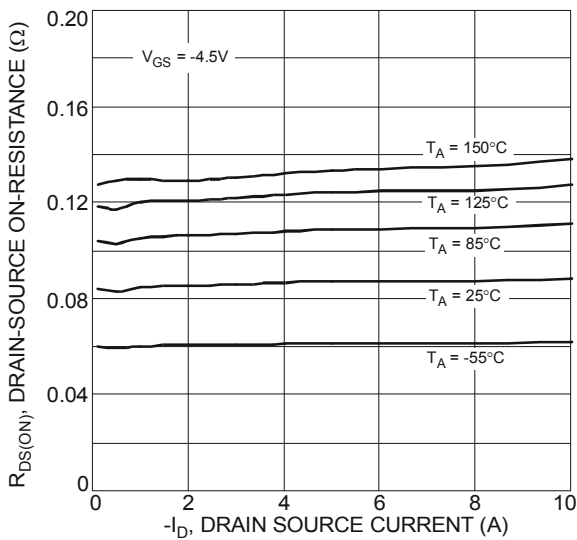
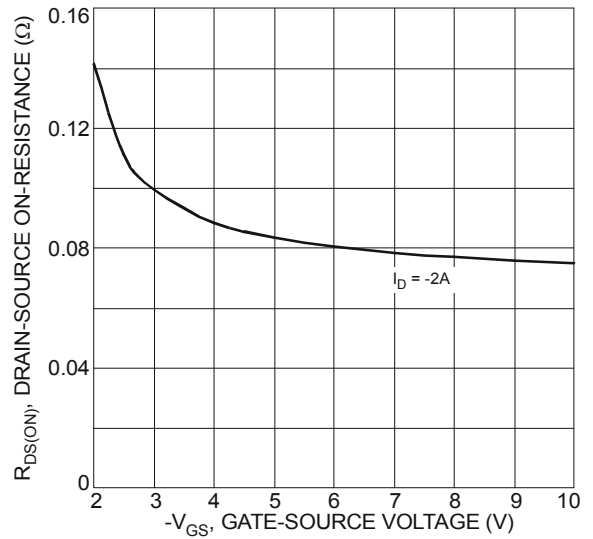
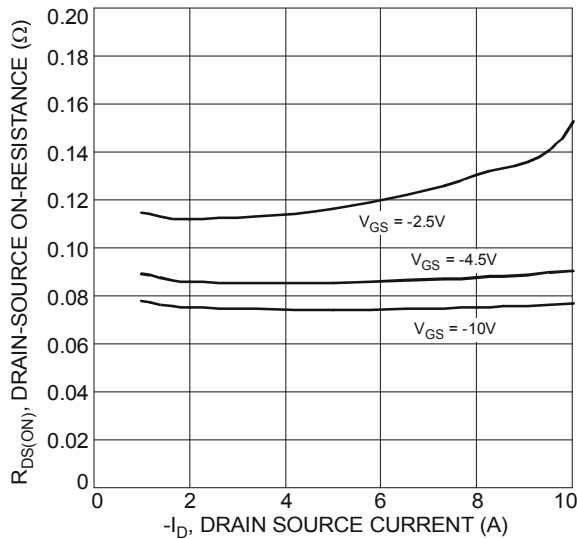
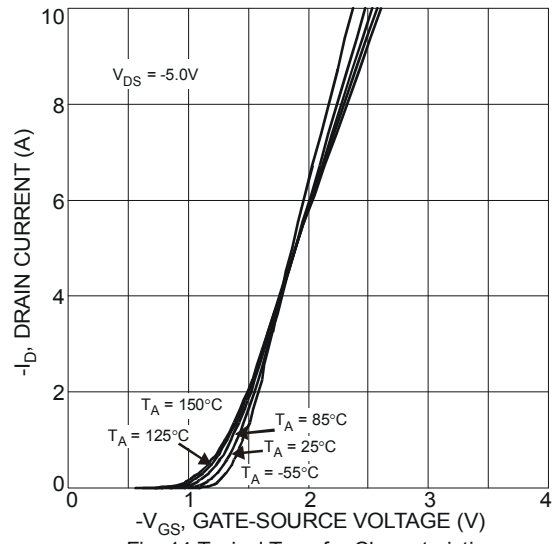
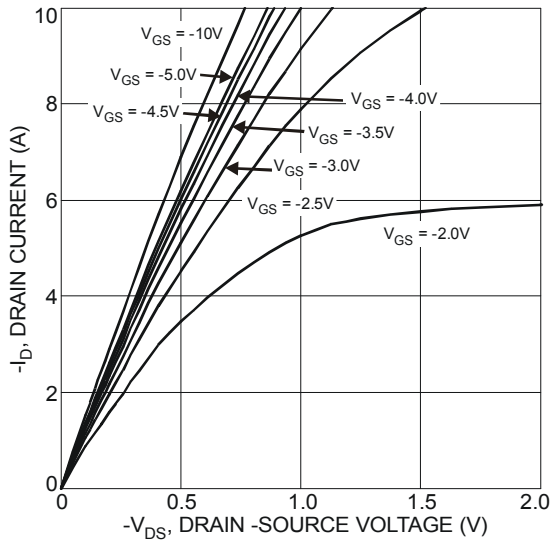

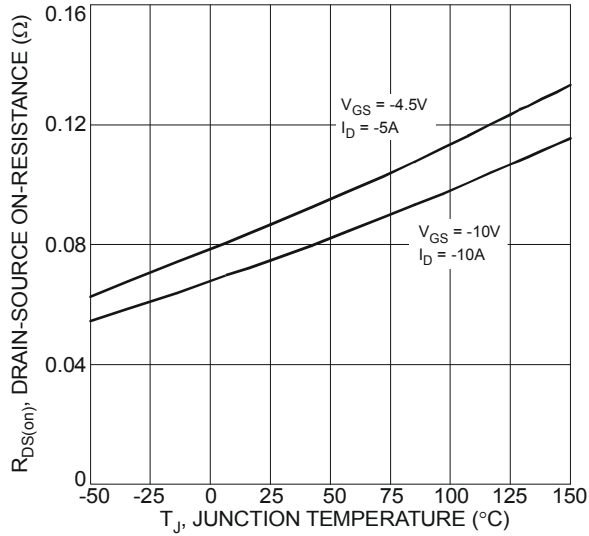

Fig. 19 On-Resistance Variation with Temperature

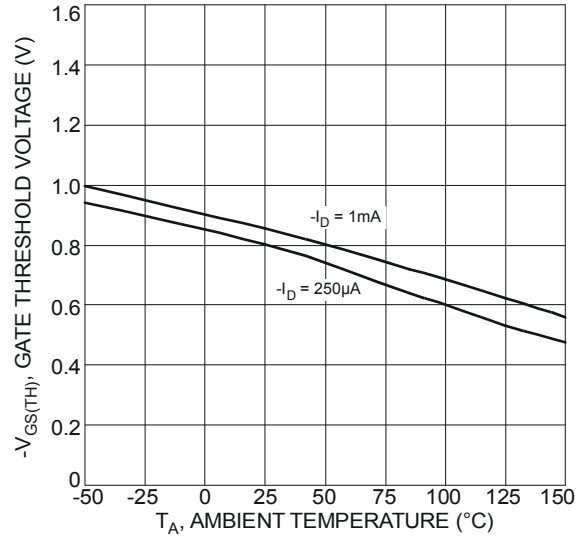

Fig. 20 Gate Threshold Variation vs. Ambient Temperature

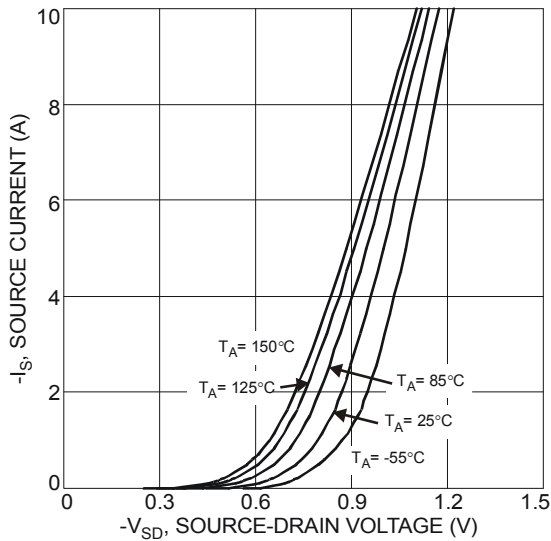

Fig. 21 Diode Forward Voltage vs. Current

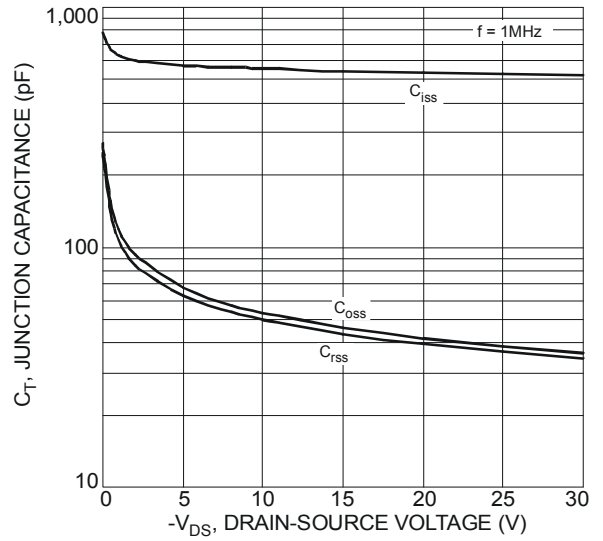

Fig. 22 Typical Junction Capacitance

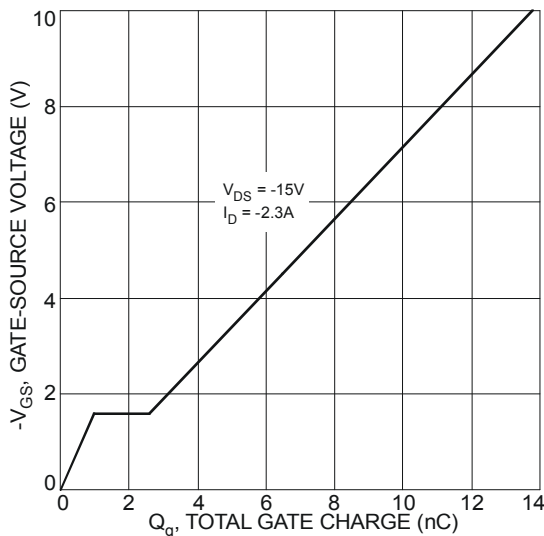
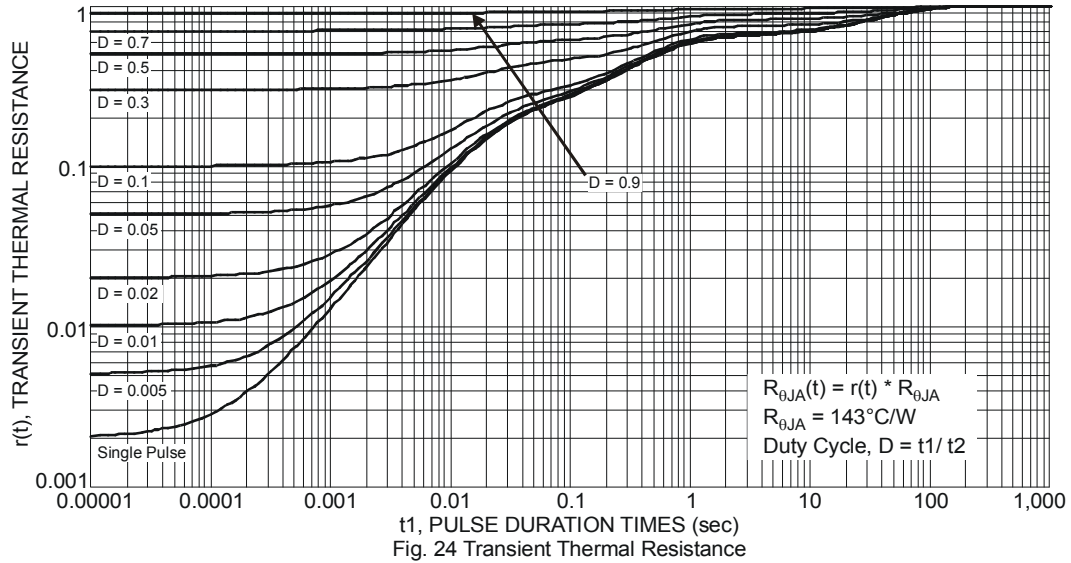
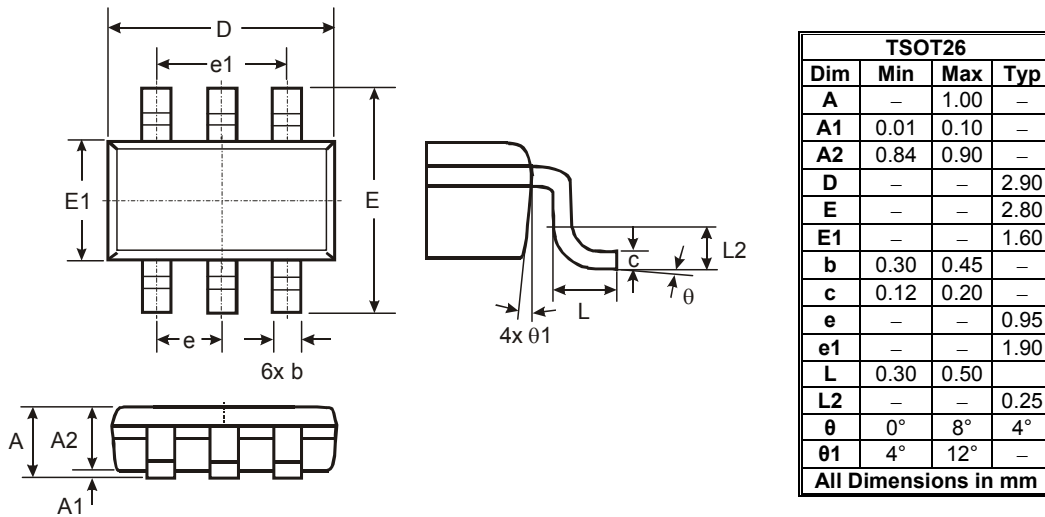

Fig. 23 Gate-Charge Characteristics



Package Outline Dimensions



Suggested Pad Layout

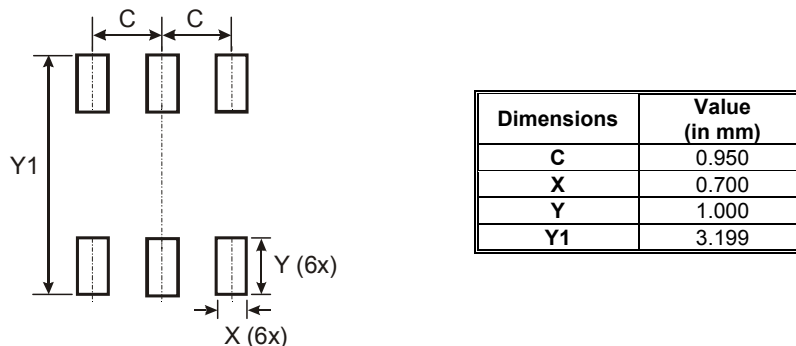

IMPORTANT NOTICE

DIODES INCORPORATED MAKES NO WARRANTY OF ANY KIND, EXPRESS OR IMPLIED, WITH REGARDS TO THIS DOCUMENT, INCLUDING, BUT NOT LIMITED TO, THE IMPLIED WARRANTIES OF MERCHANTABILITY AND FITNESS FOR A PARTICULAR PURPOSE (AND THEIR EQUIVALENTS UNDER THE LAWS OF ANY JURISDICTION).

Diodes Incorporated and its subsidiaries reserve the right to make modifications, enhancements, improvements, corrections or other changes without further notice to this document and any product described herein. Diodes Incorporated does not assume any liability arising out of the application or use of this document or any product described herein; neither does Diodes Incorporated convey any license under its patent or trademark rights, nor the rights of others. Any Customer or user of this document or products described herein in such applications shall assume all risks of such use and will agree to hold Diodes Incorporated and all the companies whose products are represented on Diodes Incorporated website, harmless against all damages.

Diodes Incorporated does not warrant or accept any liability whatsoever in respect of any products purchased through unauthorized sales channel. Should Customers purchase or use Diodes Incorporated products for any unintended or unauthorized application, Customers shall indemnify and hold Diodes Incorporated and its representatives harmless against all claims, damages, expenses, and attorney fees arising out of, directly or indirectly, any claim of personal injury or death associated with such unintended or unauthorized application.

Products described herein may be covered by one or more United States, international or foreign patents pending. Product names and markings noted herein may also be covered by one or more United States, international or foreign trademarks.

LIFE SUPPORT

Diodes Incorporated products are specifically not authorized for use as critical components in life support devices or systems without the express written approval of the Chief Executive Officer of Diodes Incorporated. As used herein:

A. Life support devices or systems are devices or systems which:

1. are intended to implant into the body, or
2. support or sustain life and whose failure to perform when properly used in accordance with instructions for use provided in the labeling can be reasonably expected to result in significant injury to the user.

B. A critical component is any component in a life support device or system whose failure to perform can be reasonably expected to cause the failure of the life support device or to affect its safety or effectiveness.

Customers represent that they have all necessary expertise in the safety and regulatory ramifications of their life support devices or systems, and acknowledge and agree that they are solely responsible for all legal, regulatory and safety-related requirements concerning their products and any use of Diodes Incorporated products in such safety-critical, life support devices or systems, notwithstanding any devices- or systems-related information or support that may be provided by Diodes Incorporated. Further, Customers must fully indemnify Diodes Incorporated and its representatives against any damages arising out of the use of Diodes Incorporated products in such safety-critical, life support devices or systems.

Copyright © 2012, Diodes Incorporated

www.diodes.com

Mouser Electronics

Authorized Distributor

Click to View Pricing, Inventory, Delivery & Lifecycle Information:

[Diodes Incorporated:](#)

[DMG6601LVT-7](#)