

Product Summary

$V_{(BR)DSS}$	$R_{DS(ON) \max}$	$I_D \max$ $T_A = 25^\circ C$
30V	13mΩ @ $V_{GS} = 10V$	9.5A
	14mΩ @ $V_{GS} = 4.5V$	9.0A

Features and Benefits

- DIOFET utilizes a unique patented process to monolithically integrate a MOSFET and a Schottky in a single die to deliver:
 - Low $R_{DS(ON)}$ – minimize conduction losses
 - Low V_{SD} – reducing the losses due to body diode conduction
 - Low Q_{rr} – lower Q_{rr} of the integrated Schottky reduces body diode switching losses
 - Low gate capacitance (Q_g/Q_{gs}) ratio – reduces risk of shoot-through or cross conduction currents at high frequencies
- Small form factor thermally efficient package enables higher density end products
- Occupies just 33% of the board area occupied by SO-8 enabling smaller end product
- 100% UIS (Avalanche) rated
- 100% Rg tested
- **Totally Lead-Free & Fully RoHS Compliant (Notes 1 & 2)**
- **Halogen and Antimony Free. "Green" Device (Note 3)**
- **Qualified to AEC-Q101 Standards for High Reliability**

Description and Applications

This MOSFET has been designed to minimize the on-state resistance ($R_{DS(on)}$) and yet maintain superior switching performance, making it ideal for high efficiency power management applications.

- Backlighting
- Power Management Functions
- DC-DC Converters

Mechanical Data

- Case: POWERDI3333-8
- Case Material: Molded Plastic, "Green" Molding Compound. UL Flammability Classification Rating 94V-0
- Moisture Sensitivity: Level 1 per J-STD-020
- Terminal Connections Indicator: See diagram
- Terminals: Finish — Matte Tin annealed over Copper leadframe. Solderable per MIL-STD-202, Method 208 (E3)
- Weight: 0.072 grams (approximate)

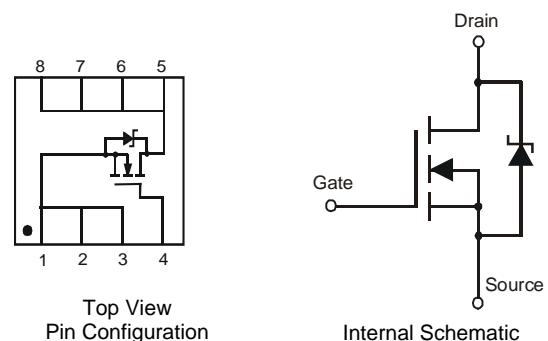
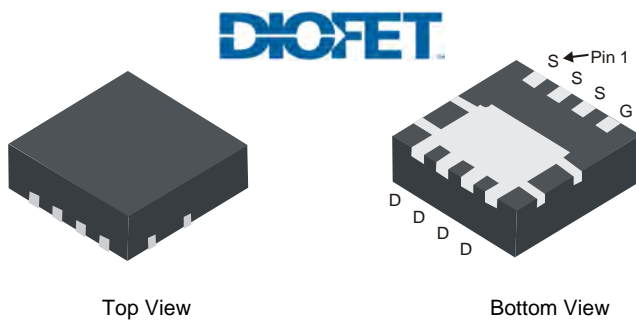

Ordering Information (Note 4)

Part Number	Case	Packaging
DMS3014SFG-7	POWERDI3333-8	2000/Tape & Reel
DMS3014SFG-13	POWERDI3333-8	3000/Tape & Reel

- Notes:
1. No purposely added lead. Fully EU Directive 2002/95/EC (RoHS) & 2011/65/EU (RoHS 2) compliant.
 2. See <http://www.diodes.com> for more information about Diodes Incorporated's definitions of Halogen- and Antimony-free, "Green" and Lead-free.
 3. Halogen- and Antimony-free "Green" products are defined as those which contain <900ppm bromine, <900ppm chlorine (<1500ppm total Br + Cl) and <1000ppm antimony compounds.
 4. For packaging details, go to our website at <http://www.diodes.com>.

Marking Information

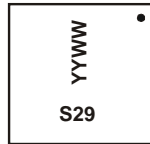

S29 = Product Type Marking Code
 YYWW = Date Code Marking
 YY = Last digit of year (ex: 11 = 2011)
 WW = Week code (01 ~ 53)

Maximum Ratings @ $T_A = 25^\circ\text{C}$ unless otherwise specified

Characteristic			Symbol	Value	Units
Drain-Source Voltage			V_{DSS}	30	V
Gate-Source Voltage			V_{GSS}	± 12	V
Continuous Drain Current (Note 6) $V_{GS} = 10\text{V}$	Steady State	$T_A = 25^\circ\text{C}$ $T_A = 70^\circ\text{C}$	I_D	9.5 7.6	A
	t<10s	$T_A = 25^\circ\text{C}$ $T_A = 70^\circ\text{C}$	I_D	13.0 9.7	A
Continuous Drain Current (Note 6) $V_{GS} = 4.5\text{V}$	Steady State	$T_A = 25^\circ\text{C}$ $T_A = 70^\circ\text{C}$	I_D	9.0 7.4	A
	t<10s	$T_A = 25^\circ\text{C}$ $T_A = 70^\circ\text{C}$	I_D	12.2 9.3	A
Pulsed Drain Current (10 μs pulse, duty cycle = 1%)			I_{DM}	80	A
Maximum Continuous Body Diode Forward Current (Note 6)			I_S	3.0	A
Avalanche Current (Note 7) L = 0.1mH			I_{AR}	30	A
Repetitive Avalanche Energy (Note 7) L = 0.1mH			E_{AR}	45	mJ

Thermal Characteristics @ $T_A = 25^\circ\text{C}$ unless otherwise specified

Characteristic		Symbol	Value	Units
Total Power Dissipation (Note 5)		P_D	1	W
Thermal Resistance, Junction to Ambient (Note 5)	Steady state	$R_{\theta JA}$	131	$^\circ\text{C/W}$
	t<10s		72	$^\circ\text{C/W}$
Total Power Dissipation (Note 6)		P_D	2.1	W
Thermal Resistance, Junction to Ambient (Note 6)	Steady state	$R_{\theta JA}$	63	$^\circ\text{C/W}$
	t<10s		35	$^\circ\text{C/W}$
Thermal Resistance, Junction to Case (Note 6)		$R_{\theta JC}$	7.1	$^\circ\text{C/W}$
Operating and Storage Temperature Range		T_J, T_{STG}	-55 to +150	$^\circ\text{C}$

- Notes:
5. Device mounted on FR-4 substrate PC board, 2oz copper, with minimum recommended pad layout.
 6. Device mounted on FR-4 substrate PC board, 2oz copper, with 1inch square copper plate.
 7. I_{AR} and E_{AR} rating are based on low frequency and duty cycles to keep $T_J = 25^\circ\text{C}$

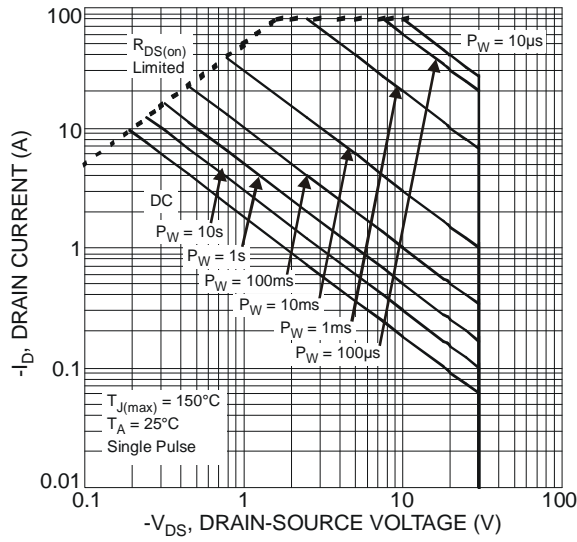

Fig. 1 SOA, Safe Operation Area

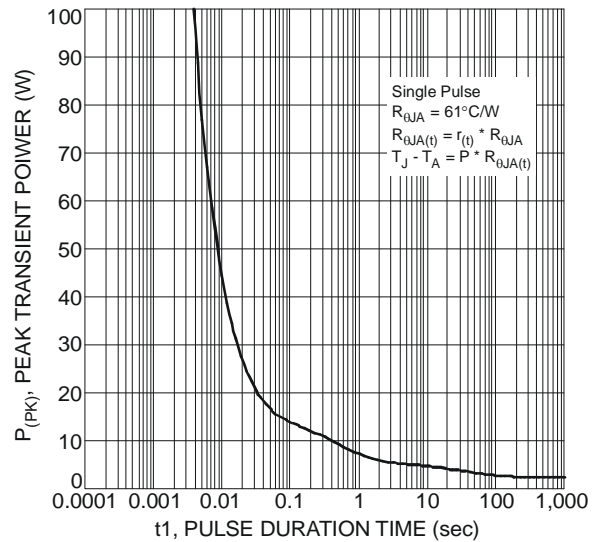

Fig. 2 Single Pulse Maximum Power Dissipation

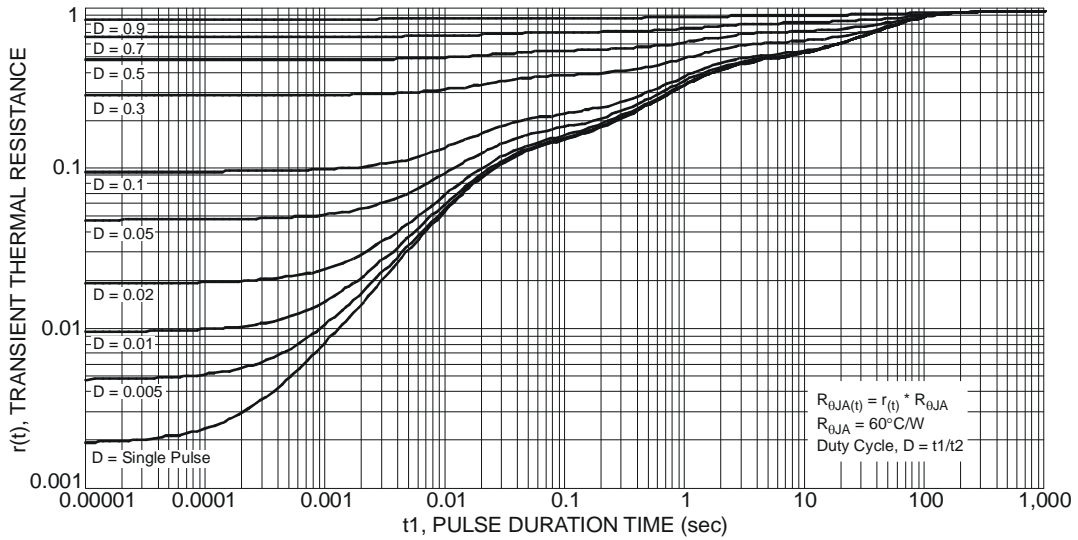
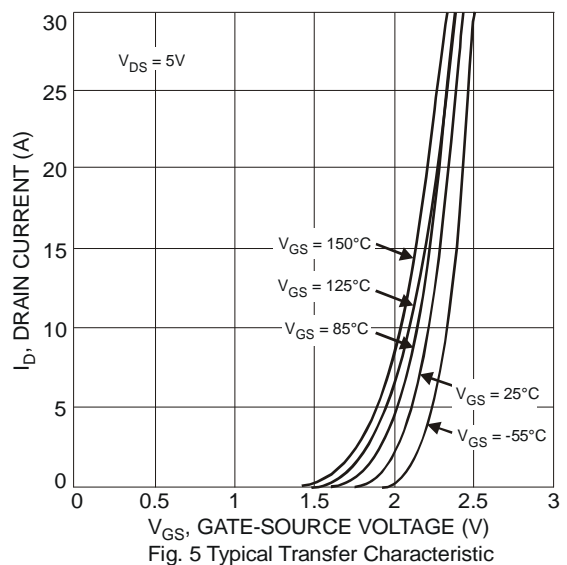
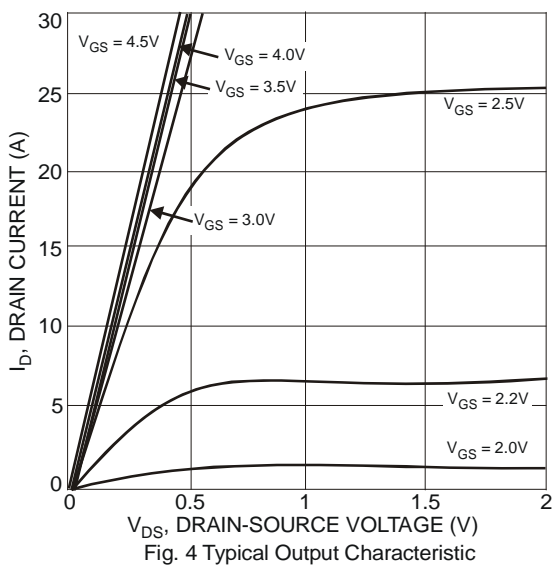

Fig. 3 Transient Thermal Resistance

Electrical Characteristics $T_A = 25^\circ\text{C}$ unless otherwise specified

Characteristic	Symbol	Min	Typ	Max	Unit	Test Condition
OFF CHARACTERISTICS (Note 8)						
Drain-Source Breakdown Voltage	BV_{DSS}	30	-	-	V	$V_{GS} = 0V, I_D = 250\mu A$
Zero Gate Voltage Drain Current	I_{DSS}	-	-	100	μA	$V_{DS} = 30V, V_{GS} = 0V$
Gate-Source Leakage	I_{GSS}	-	-	± 100	nA	$V_{GS} = \pm 12V, V_{DS} = 0V$
ON CHARACTERISTICS (Note 8)						
Gate Threshold Voltage	$V_{GS(th)}$	1.0	-	2.2	V	$V_{DS} = V_{GS}, I_D = 250\mu A$
Static Drain-Source On-Resistance	$R_{DS(on)}$	-	9	13	m Ω	$V_{GS} = 10V, I_D = 10.4A$
		-	10	14		$V_{GS} = 4.5V, I_D = 10.4A$
Forward Transfer Admittance	$ Y_{fs} $	-	23	-	S	$V_{DS} = 5V, I_D = 10.4A$
Diode Forward Voltage	V_{SD}	-	0.4	0.55	V	$V_{GS} = 0V, I_S = 1A$
DYNAMIC CHARACTERISTICS (Note 9)						
Input Capacitance	C_{iss}	-	2296	4310	pF	$V_{DS} = 15V, V_{GS} = 0V, f = 1.0MHz$
Output Capacitance	C_{oss}	-	164	-	pF	
Reverse Transfer Capacitance	C_{rss}	-	120	-	pF	
Gate Resistance	R_g	0.26	1.3	2.34	Ω	$V_{DS} = 0V, V_{GS} = 0V, f = 1MHz$
Total Gate Charge $V_{GS} = 4.5V$	Q_g	-	19.3	-	nC	$V_{DS} = 15V, V_{GS} = 10V, I_D = 10.4A$
Total Gate Charge $V_{GS} = 10V$	Q_g	-	45.7	-	nC	
Gate-Source Charge	Q_{gs}	-	5.0	-	nC	
Gate-Drain Charge	Q_{gd}	-	2.9	-	nC	
Turn-On Delay Time	$t_{D(on)}$	-	5.5	-	ns	$V_{GS} = 10V, V_{DS} = 15V, R_G = 3\Omega, R_L = 1.2\Omega$
Turn-On Rise Time	t_r	-	24.4	-	ns	
Turn-Off Delay Time	$t_{D(off)}$	-	33.1	-	ns	
Turn-Off Fall Time	t_f	-	6.6	-	ns	
Reverse Recovery Time	t_{rr}	-	12.9	-	ns	$I_F = 13A, di/dt = 500A/\mu s$
Reverse Recovery Charge	Q_{rr}	-	8.0	-	nC	$I_F = 13A, di/dt = 500A/\mu s$

Notes: 8. Short duration pulse test used to minimize self-heating effect.
 9. Guaranteed by design. Not subject to product testing.



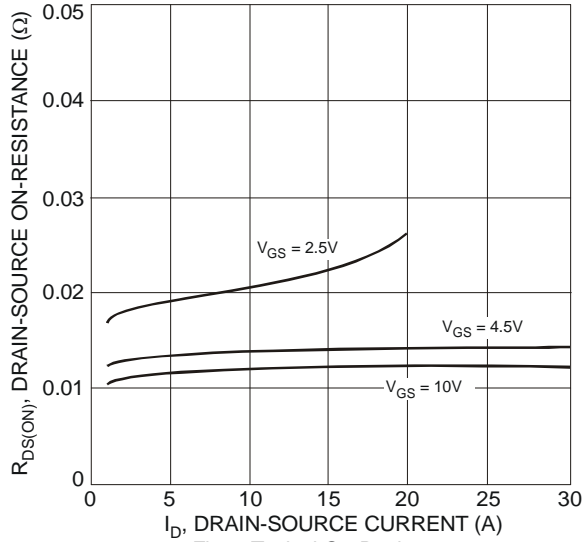

Fig. 6 Typical On-Resistance vs. Drain Current and Gate Voltage

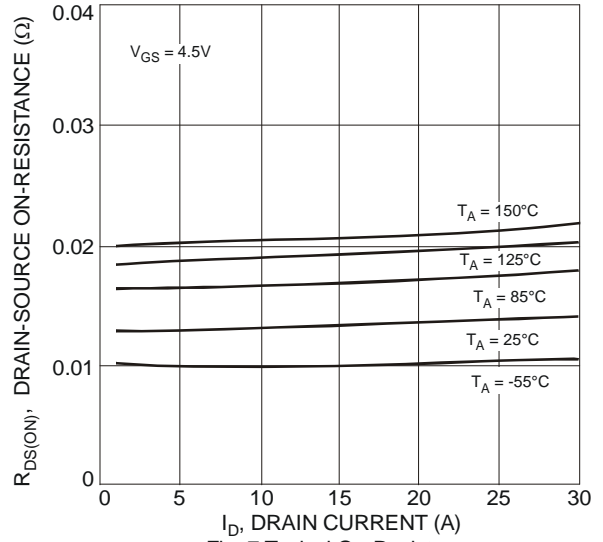

Fig. 7 Typical On-Resistance vs. Drain Current and Temperature

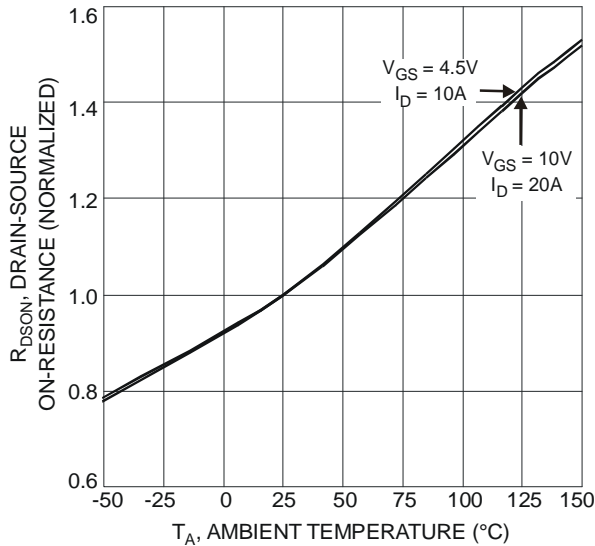

Fig. 8 On-Resistance Variation with Temperature

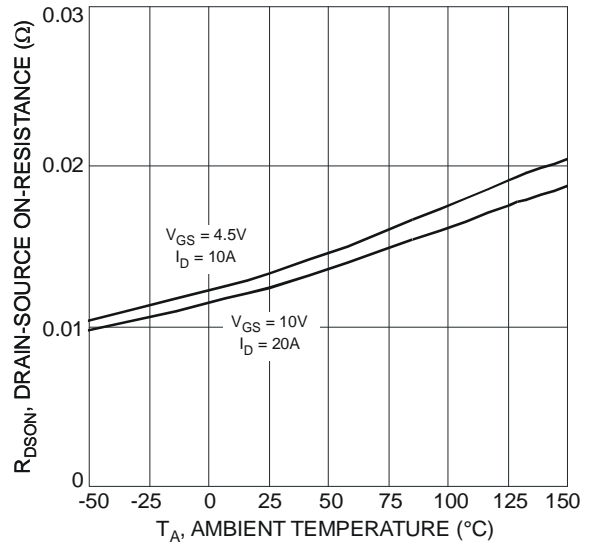

Fig. 9 On-Resistance Variation with Temperature

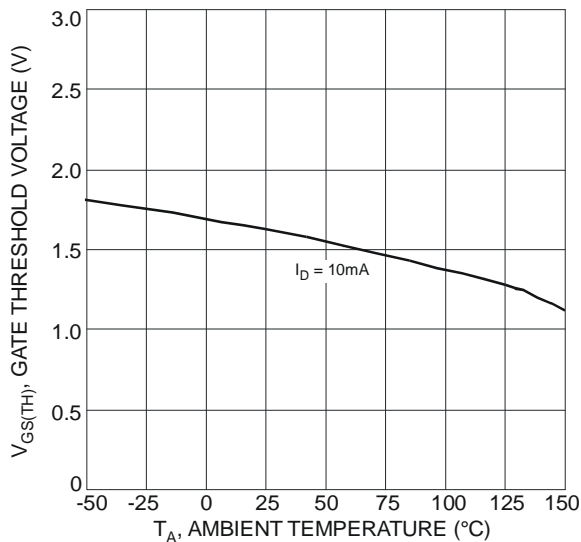

Fig. 10 Gate Threshold Variation vs. Ambient Temperature

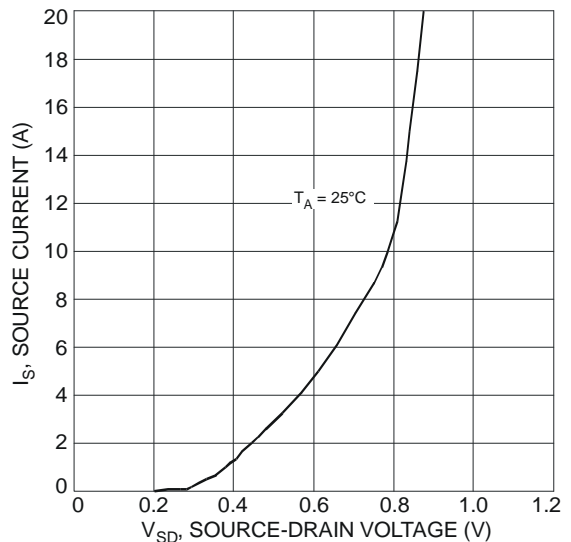

Fig. 11 Diode Forward Voltage vs. Current

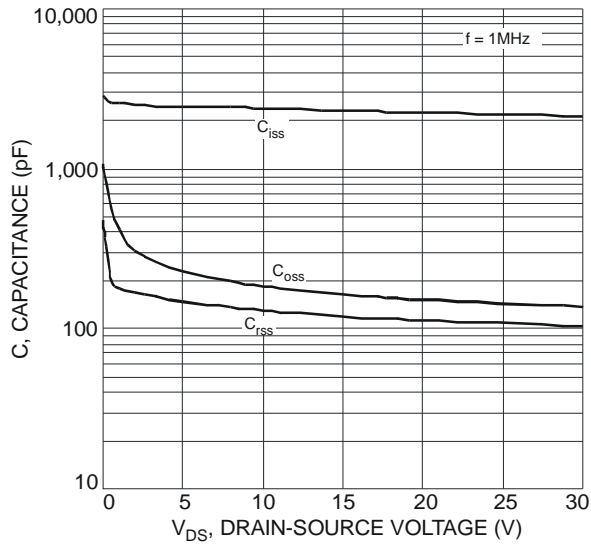

Fig. 12 Typical Total Capacitance

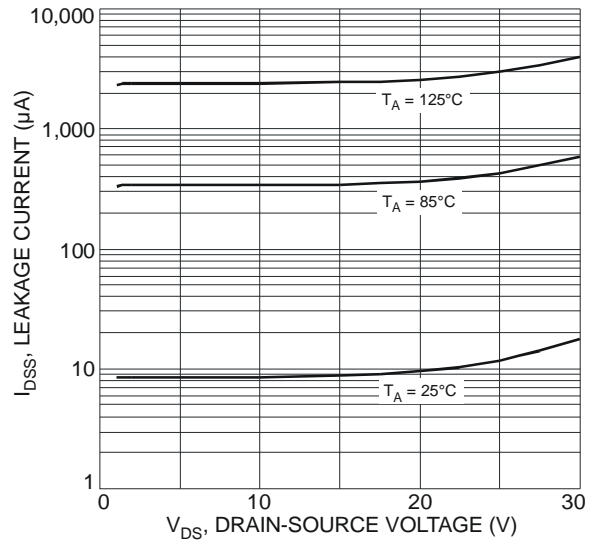

Fig. 13 Typical Leakage Current vs. Drain-Source Voltage

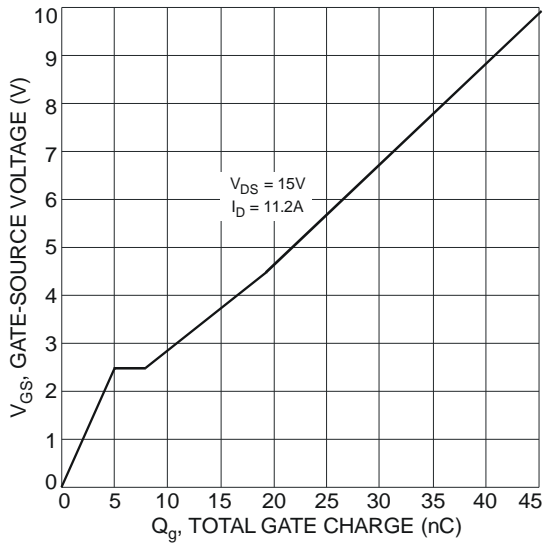
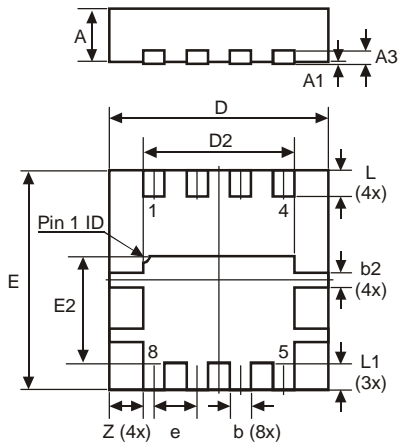

Fig. 14 Gate-Source Voltage vs. Total Gate Charge

Package Outline Dimensions



POWERDI3333-8			
Dim	Min	Max	Typ
D	3.25	3.35	3.30
E	3.25	3.35	3.30
D2	2.22	2.32	2.27
E2	1.56	1.66	1.61
A	0.75	0.85	0.80
A1	0	0.05	0.02
A3	-	-	0.203
b	0.27	0.37	0.32
b2	-	-	0.20
L	0.35	0.45	0.40
L1	-	-	0.39
e	-	-	0.65
Z	-	-	0.515
All Dimensions in mm			

Suggested Pad Layout

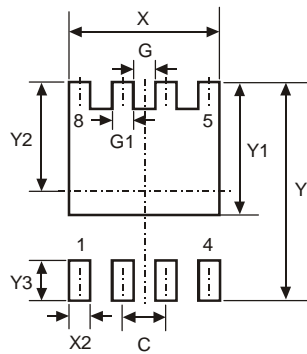

Dimensions	Value (in mm)
C	0.650
G	0.230
G1	0.420
Y	3.700
Y1	2.250
Y2	1.850
Y3	0.700
X	2.370
X2	0.420

IMPORTANT NOTICE

DIODES INCORPORATED MAKES NO WARRANTY OF ANY KIND, EXPRESS OR IMPLIED, WITH REGARDS TO THIS DOCUMENT, INCLUDING, BUT NOT LIMITED TO, THE IMPLIED WARRANTIES OF MERCHANTABILITY AND FITNESS FOR A PARTICULAR PURPOSE (AND THEIR EQUIVALENTS UNDER THE LAWS OF ANY JURISDICTION).

Diodes Incorporated and its subsidiaries reserve the right to make modifications, enhancements, improvements, corrections or other changes without further notice to this document and any product described herein. Diodes Incorporated does not assume any liability arising out of the application or use of this document or any product described herein; neither does Diodes Incorporated convey any license under its patent or trademark rights, nor the rights of others. Any Customer or user of this document or products described herein in such applications shall assume all risks of such use and will agree to hold Diodes Incorporated and all the companies whose products are represented on Diodes Incorporated website, harmless against all damages.

Diodes Incorporated does not warrant or accept any liability whatsoever in respect of any products purchased through unauthorized sales channel. Should Customers purchase or use Diodes Incorporated products for any unintended or unauthorized application, Customers shall indemnify and hold Diodes Incorporated and its representatives harmless against all claims, damages, expenses, and attorney fees arising out of, directly or indirectly, any claim of personal injury or death associated with such unintended or unauthorized application.

Products described herein may be covered by one or more United States, international or foreign patents pending. Product names and markings noted herein may also be covered by one or more United States, international or foreign trademarks.

LIFE SUPPORT

Diodes Incorporated products are specifically not authorized for use as critical components in life support devices or systems without the express written approval of the Chief Executive Officer of Diodes Incorporated. As used herein:

A. Life support devices or systems are devices or systems which:

1. are intended to implant into the body, or
2. support or sustain life and whose failure to perform when properly used in accordance with instructions for use provided in the labeling can be reasonably expected to result in significant injury to the user.

B. A critical component is any component in a life support device or system whose failure to perform can be reasonably expected to cause the failure of the life support device or to affect its safety or effectiveness.

Customers represent that they have all necessary expertise in the safety and regulatory ramifications of their life support devices or systems, and acknowledge and agree that they are solely responsible for all legal, regulatory and safety-related requirements concerning their products and any use of Diodes Incorporated products in such safety-critical, life support devices or systems, notwithstanding any devices- or systems-related information or support that may be provided by Diodes Incorporated. Further, Customers must fully indemnify Diodes Incorporated and its representatives against any damages arising out of the use of Diodes Incorporated products in such safety-critical, life support devices or systems.

Copyright © 2012, Diodes Incorporated

www.diodes.com

Mouser Electronics

Authorized Distributor

Click to View Pricing, Inventory, Delivery & Lifecycle Information:

[Diodes Incorporated:](#)

[DMS3014SFG-7](#)