

COMPLEMENTARY 20V LOW SATURATION TRANSISTORS

Features

- NPN Transistor
- $BV_{CEO} > 20V$
 - $I_C = 4.5A$ Continuous Collector Current
 - Low Saturation Voltage (150mV max @ 1A)
 - $R_{SAT} = 47m\Omega$ for a low equivalent On-Resistance
- PNP Transistor
- $BV_{CEO} > -20V$
 - $I_C = -3.5A$ Continuous Collector Current
 - Low Saturation Voltage (-220mV max @ -1A)
 - $R_{SAT} = 64m\Omega$ for a low equivalent On-Resistance
- h_{FE} characterized up to 6A for high current gain hold up
 - Low profile 0.8mm high package for thin applications
 - $R_{\theta JA}$ efficient, 40% lower than SOT26
 - 6mm² footprint, 50% smaller than TSOP6 and SOT26
 - **Lead-Free Finish; RoHS Compliant (Notes 1 & 2)**
 - **Halogen and Antimony Free. "Green" Device (Note 3)**
 - **Qualified to AEC-Q101 Standards for High Reliability**
 - **PPAP capable (Note 4)**

Mechanical Data

- Case: W-DFN3020-8 Type B
- Nominal package height: 0.8mm
- Case material: molded plastic. "Green" molding compound.
- UL Flammability Rating 94V-0
- Moisture Sensitivity: Level 1 per J-STD-020
- Terminals: Finish - NiPdAu, Solderable per MIL-STD-202, Method 208 (e4)
- Weight: 0.013 grams (approximate)

Applications

- DC – DC Converters
- Charging circuits
- Power switches
- Motor control
- LED Backlighting circuits
- Portable applications

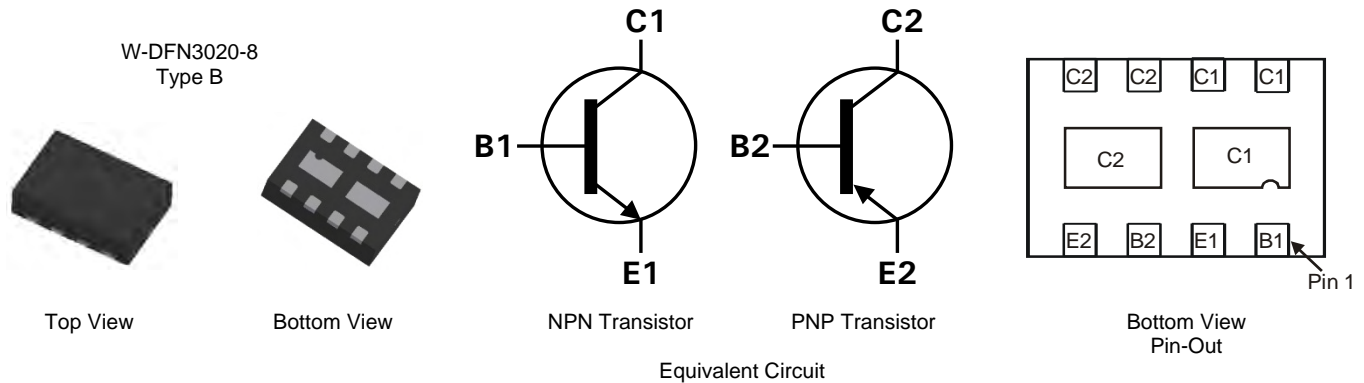

Ordering Information (Note 4 & 5)

| Product | Compliance | Marking | Reel size (inches) | Tape width (mm) | Quantity per reel |
|---------------|------------|---------|--------------------|-----------------|-------------------|
| ZXTC6718MCTA | AEC-Q101 | DB2 | 7 | 8 | 3,000 |
| ZXTC6718MCQTA | Automotive | DB2 | 7 | 8 | 3,000 |

- Notes:
1. EU Directive 2002/95/EC (RoHS) & 2011/65/EU (RoHS 2) compliant. All applicable RoHS exemptions applied.
 2. See <http://www.diodes.com> for more information about Diodes Incorporated's definitions of Halogen- and Antimony-free, "Green" and Lead-free.
 3. Halogen- and Antimony-free "Green" products are defined as those which contain <900ppm bromine, <900ppm chlorine (<1500ppm total Br + Cl) and <1000ppm antimony compounds.
 4. Automotive products are AEC-Q101 qualified and are PPAP capable. Automotive, AEC-Q101 and standard products are electrically and thermally the same, except where specified.
 5. For packaging details, go to our website at <http://www.diodes.com>

Marking Information



DB2 = Product type marking code
Top view, dot denotes pin 1

Maximum Ratings (@T_A = +25°C, unless otherwise specified.)

| Characteristic | Symbol | NPN | PNP | Unit |
|------------------------------|------------------|-----|------|------|
| Collector-Base Voltage | V _{CB0} | 40 | -25 | V |
| Collector-Emitter Voltage | V _{CEO} | 20 | -20 | V |
| Emitter-Base Voltage | V _{EBO} | 7 | -7 | V |
| Peak Pulse Current | I _{CM} | 12 | -6 | A |
| Continuous Collector Current | I _C | 4.5 | -3.5 | A |
| Continuous Collector Current | | 5 | -3.8 | |
| Base Current | I _B | 1 | | A |

Thermal Characteristics (@T_A = +25°C, unless otherwise specified.)

| Characteristic | Symbol | NPN | PNP | Unit |
|---|-----------------------------------|-------------|-----|------|
| Power Dissipation Linear Derating Factor | P _D | 1.5 | | W |
| | | 12 | | |
| | | 2.45 | | |
| | | 19.6 | | |
| | | 1.13 | | |
| Thermal Resistance, Junction to Ambient | R _{θJA} | 8 | | °C/W |
| | | 1.7 | | |
| | | 13.6 | | |
| Thermal Resistance, Junction to Ambient | R _{θJA} | 83.3 | | °C/W |
| | | 51.0 | | |
| | | 111 | | |
| | | 73.5 | | |
| Thermal Resistance, Junction to Lead | R _{θJL} | 17.1 | | °C |
| Operating and Storage Temperature Range | T _J , T _{STG} | -55 to +150 | | °C |

- Notes:
- For a dual device surface mounted on 28mm x 28mm (8cm²) FR4 PCB with high coverage of single sided 2 oz copper, in still air conditions; the device is measured when operating in a steady-state condition. The heatsink is split in half with the exposed collector pads connected to each half.
 - Same as note (6), except the device is measured at t < 5 sec.
 - Same as note (6), except the device is surface mounted on 31mm x 31mm (10cm²) FR4 PCB with high coverage of single sided 1oz copper.
 - For a dual device with one active die.
 - For dual device with 2 active die running at equal power.
 - Thermal resistance from junction to solder-point (on the exposed collector pads).

Thermal Characteristics and Derating Information

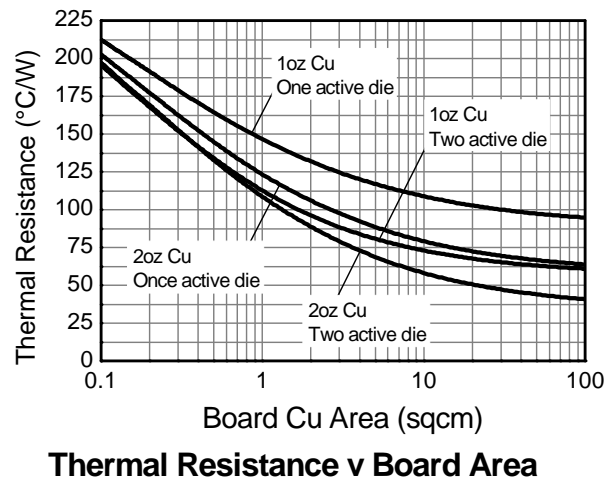
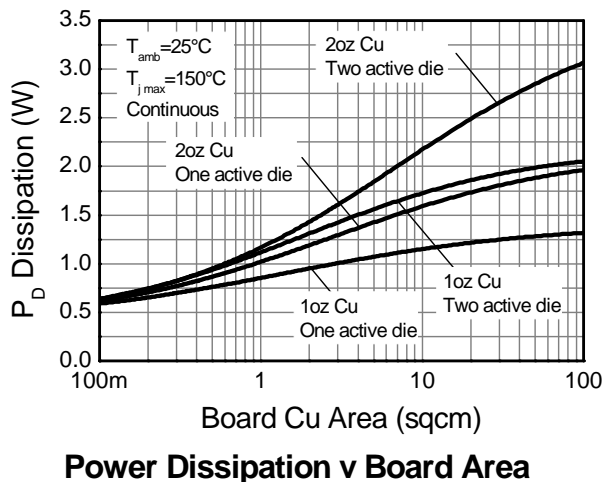
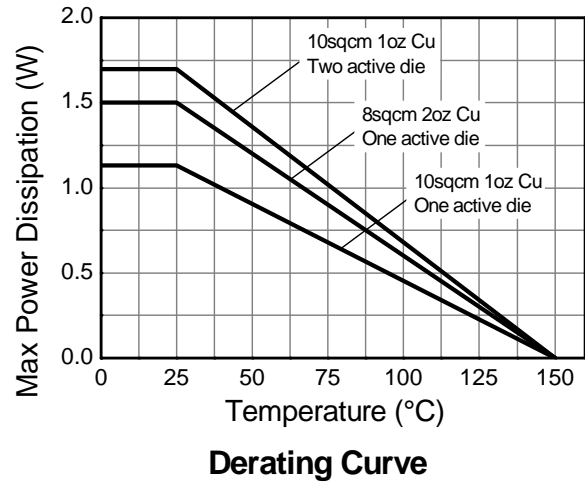
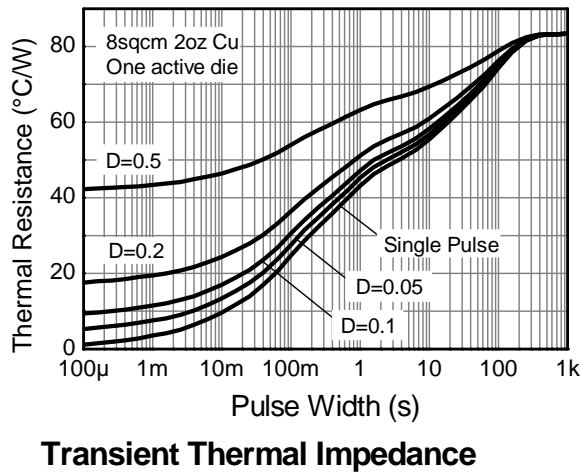
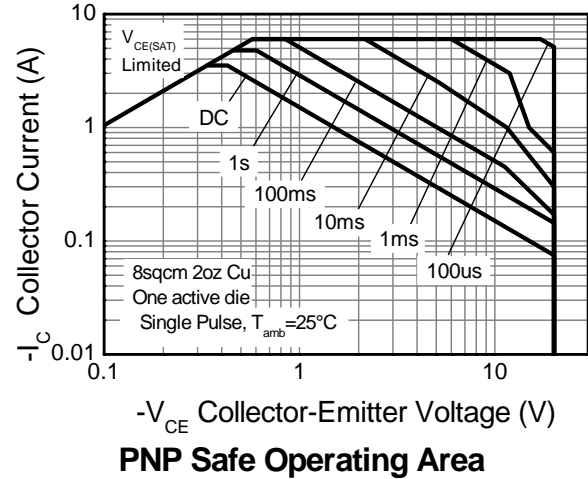
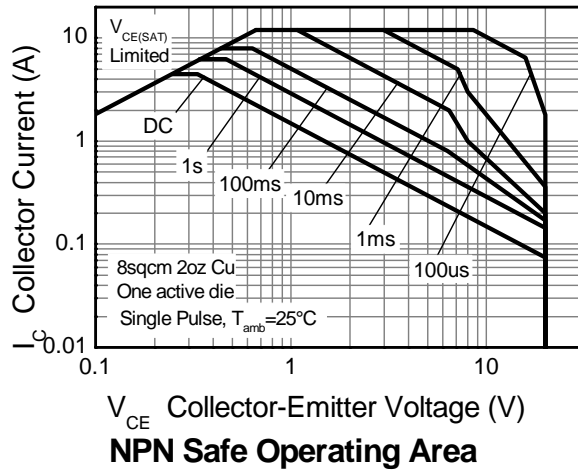

NPN - Electrical Characteristics (@T_A = +25°C, unless otherwise specified.)

| Characteristic | Symbol | Min | Typ | Max | Unit | Test Condition |
|---|----------------------|-----|------|------|------|--|
| Collector-Base Breakdown Voltage | BV _{CBO} | 40 | 100 | - | V | I _C = 100μA |
| Collector-Emitter Breakdown Voltage (Note 12) | BV _{CEO} | 20 | 27 | - | V | I _C = 10mA |
| Emitter-Base Breakdown Voltage | BV _{EBO} | 7 | 8.2 | - | V | I _E = 100μA |
| Collector Cutoff Current | I _{CBO} | - | - | 100 | nA | V _{CB} = 30V |
| Emitter Cutoff Current | I _{EBO} | - | - | 100 | nA | V _{EB} = 6V |
| Collector Emitter Cutoff Current | I _{CES} | - | - | 100 | nA | V _{CE} = 16V |
| Static Forward Current Transfer Ratio (Note 12) | h _{FE} | 200 | 400 | - | - | I _C = 10mA, V _{CE} = 2V |
| | | 300 | 450 | - | - | I _C = 200mA, V _{CE} = 2V |
| | | 200 | 360 | - | - | I _C = 2A, V _{CE} = 2V |
| | | 100 | 180 | - | - | I _C = 6A, V _{CE} = 2V |
| Collector-Emitter Saturation Voltage (Note 12) | V _{CE(sat)} | - | 8 | 15 | mV | I _C = 0.1A, I _B = 10mA |
| | | - | 90 | 150 | | I _C = 1A, I _B = 10mA |
| | | - | 115 | 135 | | I _C = 2A, I _B = 50mA |
| | | - | 190 | 250 | | I _C = 3A, I _B = 100mA |
| | | - | 210 | 300 | | I _C = 4.5A, I _B = 125mA |
| Base-Emitter Turn-On Voltage (Note 12) | V _{BE(on)} | - | 0.88 | 0.97 | V | I _C = 4.5A, V _{CE} = 2V |
| Base-Emitter Saturation Voltage (Note 12) | V _{BE(sat)} | - | 0.98 | 1.07 | V | I _C = 4.5A, I _B = 125mA |
| Output Capacitance | C _{obo} | - | 23 | 30 | pF | V _{CB} = 10V, f = 1MHz |
| Transition Frequency | f _T | 100 | 140 | - | MHz | V _{CE} = 10V, I _C = 50mA, f = 100MHz |
| Turn-on Time | t _{on} | - | 170 | - | ns | V _{CC} = 10V, I _C = 3A |
| Turn-off Time | t _{off} | - | 400 | - | ns | I _{B1} = I _{B2} = 10mA |

Notes: 12. Measured under pulsed conditions. Pulse width ≤ 300μs. Duty cycle ≤ 2%.

NPN - Typical Electrical Characteristics (@ $T_A = +25^\circ\text{C}$, unless otherwise specified.)

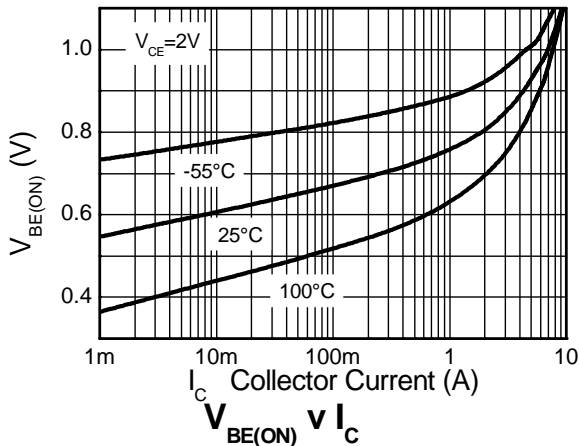
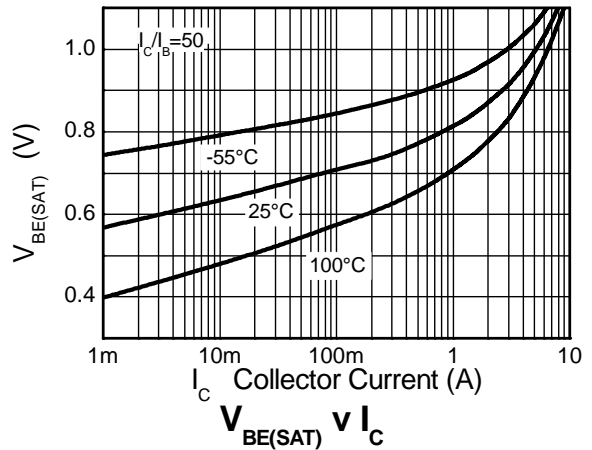
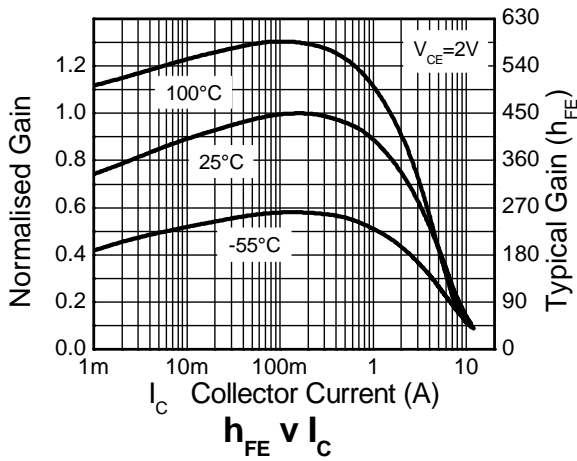
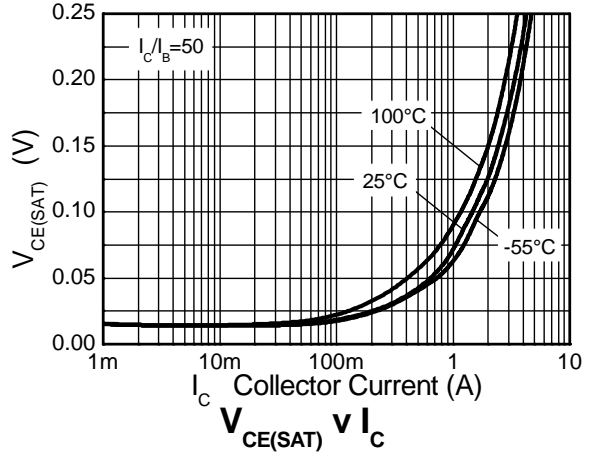
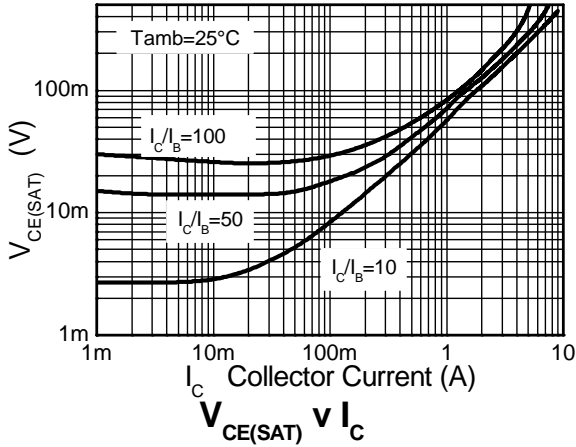

PNP - Electrical Characteristics (@T_A = +25°C, unless otherwise specified.)

| Characteristic | Symbol | Min | Typ | Max | Unit | Test Condition |
|---|----------------------|-------------------------|-------------------------------------|-------------------------------------|------|--|
| Collector-Base Breakdown Voltage | BV _{CBO} | -25 | -35 | - | V | I _C = -100μA |
| Collector-Emitter Breakdown Voltage (Note 12) | BV _{CEO} | -20 | -25 | - | V | I _C = -10mA |
| Emitter-Base Breakdown Voltage | BV _{EBO} | -7 | -8.5 | - | V | I _E = -100μA |
| Collector Cutoff Current | I _{CBO} | - | - | -100 | nA | V _{CB} = -20V |
| Emitter Cutoff Current | I _{EBO} | - | - | -100 | nA | V _{EB} = -6V |
| Collector Emitter Cutoff Current | I _{CES} | - | - | -100 | nA | V _{CES} = -16V |
| Static Forward Current Transfer Ratio (Note 12) | h _{FE} | 300 300 150 15 | 475 450 230 30 | - - - - | - | I _C = -10mA, V _{CE} = -2V I _C = -100mA, V _{CE} = -2V I _C = -2A, V _{CE} = -2V I _C = -6A, V _{CE} = -2V |
| Collector-Emitter Saturation Voltage (Note 12) | V _{CE(sat)} | - - - - - | -19 -170 -190 -240 -225 | -30 -220 -250 -350 -300 | mV | I _C = -0.1A, I _B = -10mA I _C = -1A, I _B = -20mA I _C = -1.5A, I _B = -50mA I _C = -2.5A, I _B = -150mA I _C = -3.5A, I _B = -350mA |
| Base-Emitter Turn-On Voltage (Note 12) | V _{BE(on)} | - | -0.87 | -0.95 | V | I _C = -3.5A, V _{CE} = -2V |
| Base-Emitter Saturation Voltage (Note 12) | V _{BE(sat)} | - | -1.01 | -1.12 | V | I _C = -3.5A, I _B = -350mA |
| Output Capacitance | C _{obo} | - | 21 | 30 | pF | V _{CB} = -10V, f = 1MHz |
| Transition Frequency | f _T | 150 | 180 | - | MHz | V _{CE} = -10V, I _C = -50mA, f = 100MHz |
| Turn-on Time | t _{on} | - | 40 | - | ns | V _{CC} = -10V, I _C = -1A |
| Turn-off Time | t _{off} | - | 670 | - | ns | I _{B1} = I _{B2} = -10mA |

Notes: 12. Measured under pulsed conditions. Pulse width ≤ 300μs. Duty cycle ≤ 2%.

PNP - Typical Electrical Characteristics (@ $T_A = +25^\circ\text{C}$, unless otherwise specified.)

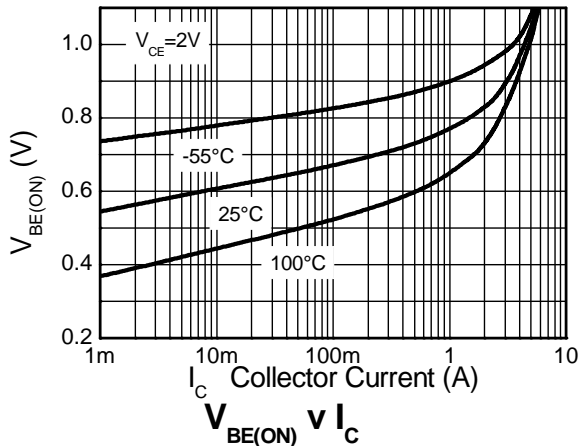
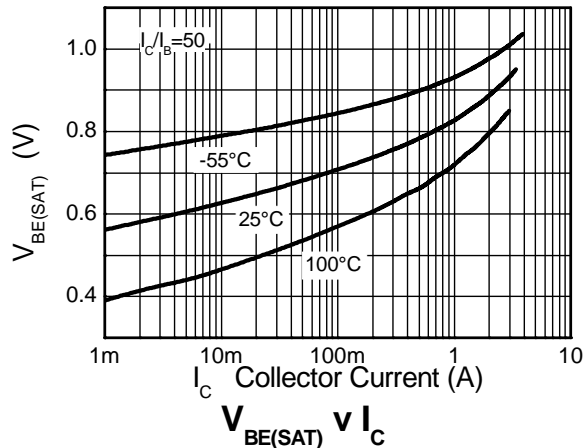
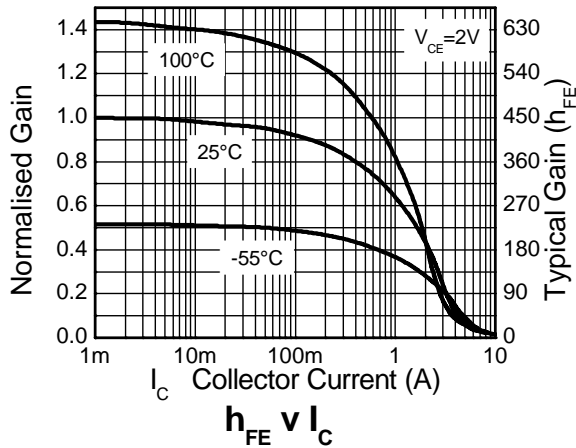
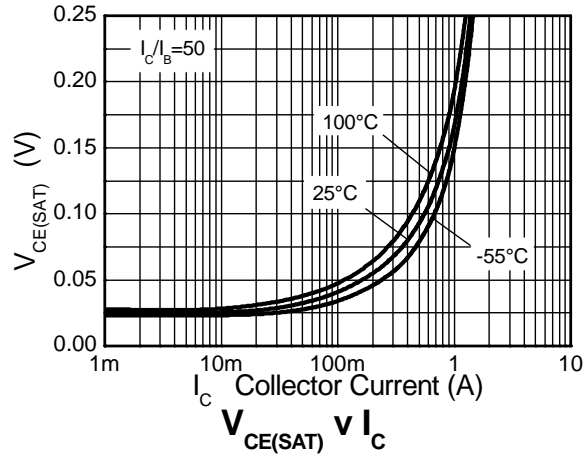
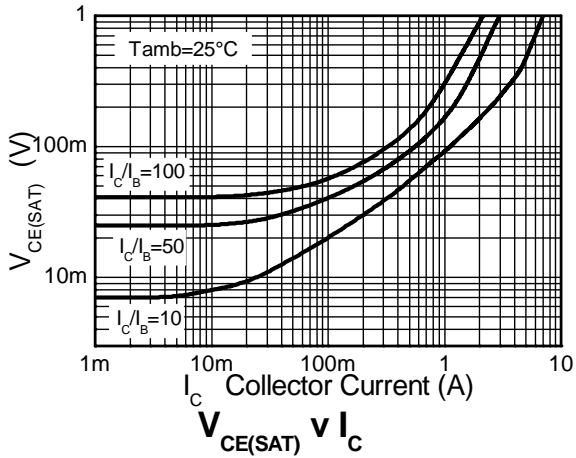

Package Outline Dimensions

Please see AP02002 at <http://www.diodes.com/datasheets/ap02002.pdf> for latest version.

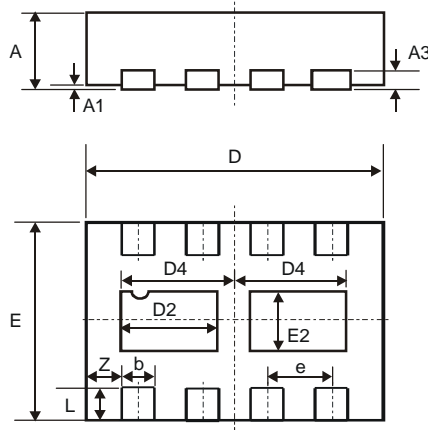

| W-DFN3020-8 Type B | | | |
|-----------------------|------|-------|-------|
| Dim | Min | Max | Typ |
| A | 0.77 | 0.83 | 0.80 |
| A1 | 0 | 0.05 | 0.02 |
| A3 | - | - | 0.15 |
| b | 0.25 | 0.35 | 0.30 |
| D | 2.95 | 3.075 | 3.00 |
| D2 | 0.82 | 1.02 | 0.92 |
| D4 | 1.01 | 1.21 | 1.11 |
| e | - | - | 0.65 |
| E | 1.95 | 2.075 | 2.00 |
| E2 | 0.43 | 0.63 | 0.53 |
| L | 0.25 | 0.35 | 0.30 |
| Z | - | - | 0.375 |
| All Dimensions in mm | | | |

Suggested Pad Layout

Please see AP02001 at <http://www.diodes.com/datasheets/ap02001.pdf> for the latest version.

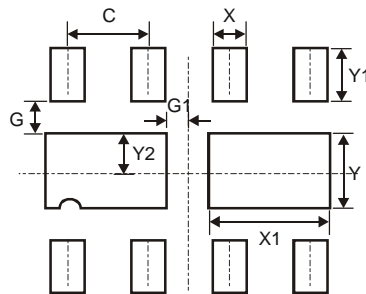

| Dimensions | Value (in mm) |
|------------|---------------|
| C | 0.650 |
| G | 0.285 |
| G1 | 0.090 |
| X | 0.400 |
| X1 | 1.120 |
| Y | 0.730 |
| Y1 | 0.500 |
| Y2 | 0.365 |

IMPORTANT NOTICE

DIODES INCORPORATED MAKES NO WARRANTY OF ANY KIND, EXPRESS OR IMPLIED, WITH REGARDS TO THIS DOCUMENT, INCLUDING, BUT NOT LIMITED TO, THE IMPLIED WARRANTIES OF MERCHANTABILITY AND FITNESS FOR A PARTICULAR PURPOSE (AND THEIR EQUIVALENTS UNDER THE LAWS OF ANY JURISDICTION).

Diodes Incorporated and its subsidiaries reserve the right to make modifications, enhancements, improvements, corrections or other changes without further notice to this document and any product described herein. Diodes Incorporated does not assume any liability arising out of the application or use of this document or any product described herein; neither does Diodes Incorporated convey any license under its patent or trademark rights, nor the rights of others. Any Customer or user of this document or products described herein in such applications shall assume all risks of such use and will agree to hold Diodes Incorporated and all the companies whose products are represented on Diodes Incorporated website, harmless against all damages.

Diodes Incorporated does not warrant or accept any liability whatsoever in respect of any products purchased through unauthorized sales channel. Should Customers purchase or use Diodes Incorporated products for any unintended or unauthorized application, Customers shall indemnify and hold Diodes Incorporated and its representatives harmless against all claims, damages, expenses, and attorney fees arising out of, directly or indirectly, any claim of personal injury or death associated with such unintended or unauthorized application.

Products described herein may be covered by one or more United States, international or foreign patents pending. Product names and markings noted herein may also be covered by one or more United States, international or foreign trademarks.

This document is written in English but may be translated into multiple languages for reference. Only the English version of this document is the final and determinative format released by Diodes Incorporated.

LIFE SUPPORT

Diodes Incorporated products are specifically not authorized for use as critical components in life support devices or systems without the express written approval of the Chief Executive Officer of Diodes Incorporated. As used herein:

A. Life support devices or systems are devices or systems which:

1. are intended to implant into the body, or
2. support or sustain life and whose failure to perform when properly used in accordance with instructions for use provided in the labeling can be reasonably expected to result in significant injury to the user.

B. A critical component is any component in a life support device or system whose failure to perform can be reasonably expected to cause the failure of the life support device or to affect its safety or effectiveness.

Customers represent that they have all necessary expertise in the safety and regulatory ramifications of their life support devices or systems, and acknowledge and agree that they are solely responsible for all legal, regulatory and safety-related requirements concerning their products and any use of Diodes Incorporated products in such safety-critical, life support devices or systems, notwithstanding any devices- or systems-related information or support that may be provided by Diodes Incorporated. Further, Customers must fully indemnify Diodes Incorporated and its representatives against any damages arising out of the use of Diodes Incorporated products in such safety-critical, life support devices or systems.

Copyright © 2012, Diodes Incorporated

www.diodes.com

Mouser Electronics

Authorized Distributor

Click to View Pricing, Inventory, Delivery & Lifecycle Information:

[Diodes Incorporated:](#)

[ZXTC6718MCTA](#)