



ZXTD619MC

DUAL 50V NPN LOW SATURATION SWITCHING TRANSISTOR

Features and Benefits

- $BV_{CEO} > 50V$
- $I_C = 4A$ Continuous Collector Current
- Low Saturation Voltage (100mV max @ 1A)
- $R_{SAT} = 68m\Omega$ for Low Equivalent On Resistance
- h_{FE} specified up to 6A for high current gain holds up
- Dual NPN saving footprint and component count
- Low profile 0.8mm high package for thin applications
- $R_{\theta JA}$ efficient, 40% lower than SOT26
- 6mm² footprint, 50% smaller than TSOP6 and SOT26
- **Lead-Free, RoHS Compliant (Note 1)**
- **Halogen and Antimony Free. "Green" Device (Note 2)**
- **Qualified to AEC-Q101 Standards for High Reliability**

Mechanical Data

- Case: DFN3020B-8
- Case Material: Molded Plastic. "Green" Molding Compound.
- Terminals: Pre-Plated NiPdAu leadframe.
- UL Flammability Rating 94V-0
- Nominal package height: 0.8mm
- Moisture Sensitivity: Level 1 per J-STD-020
- Weight: 0.013 grams (approximate)

Applications

- DC – DC Converters
- MOSFET gate drivers
- Charging circuits
- Motor Control
- Power switches
- Portable applications

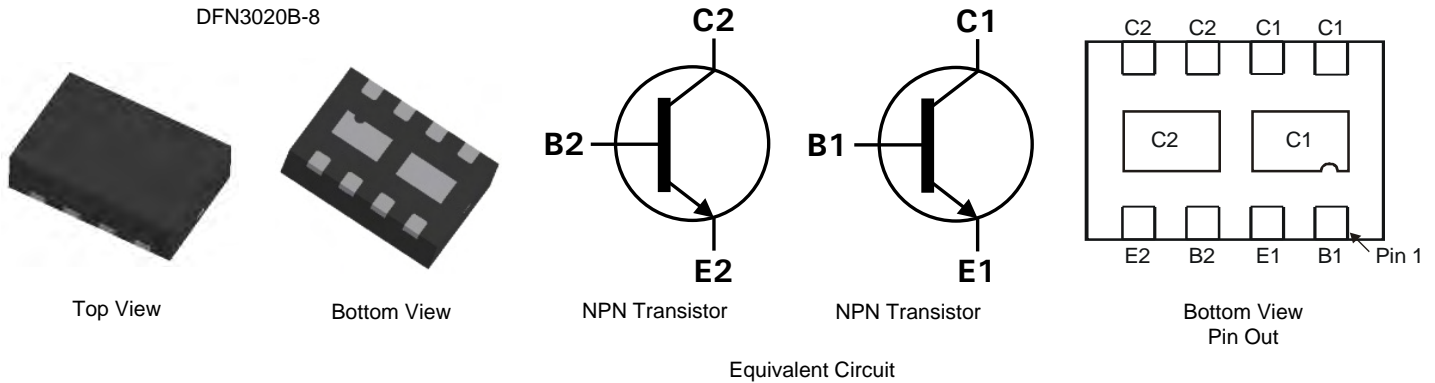

Ordering Information (Note 3)

Product	Marking	Reel size (inches)	Tape width (mm)	Quantity per reel
ZXTD619MCTA	DCC	7	8	3,000

- Notes:
1. No purposefully added lead.
 2. Diodes Inc's "Green" Policy can be found on our website at <http://www.diodes.com>
 3. For Packaging Details, go to our website at <http://www.diodes.com>.

Marking Information



DCC = Product type Marking Code
Top view, dot denotes Pin 1

Maximum Ratings @T_A = 25°C unless otherwise specified

Parameter	Symbol	Limit	Unit
Collector-Base Voltage	V _{CB0}	100	V
Collector-Emitter Voltage	V _{CEO}	50	V
Emitter-Base Voltage	V _{EBO}	7	V
Peak Pulse Current	I _{CM}	6	A
Continuous Collector Current (Note 4 and 7)	I _C	4	A
Base Current	I _B	1	A

Thermal Characteristics @T_A = 25°C unless otherwise specified

Characteristic	Symbol	Value	Unit
Power Dissipation Linear Derating Factor	P _D	1.5	W mW/°C
		12	
		2.45	
		19.6	
		1.13	
Thermal Resistance, Junction to Ambient	R _{θJA}	8	°C/W
		1.7	
		13.6	
		83.3	
Thermal Resistance, Junction to Lead	R _{θJL}	51.0	°C/W
		111	
		73.5	
Operating and Storage Temperature Range	T _J , T _{STG}	-55 to +150	°C

- Notes:
4. For a dual device surface mounted on 28mm x 28mm (8cm²) FR4 PCB with high coverage of single sided 2 oz copper, in still air conditions; the device is measured when operating in a steady-state condition. The heatsink is split in half with the exposed collector pads connected to each half.
 5. Same as note (4), except the device is measured at t < 5 sec.
 6. Same as note (4), except the device is surface mounted on 31mm x 31mm (10cm²) FR4 PCB with high coverage of single sided 1oz copper.
 7. For a dual device with one active die.
 8. For dual device with 2 active die running at equal power.
 9. Thermal resistance from junction to solder-point (at the end of the collector lead).

Thermal Characteristics

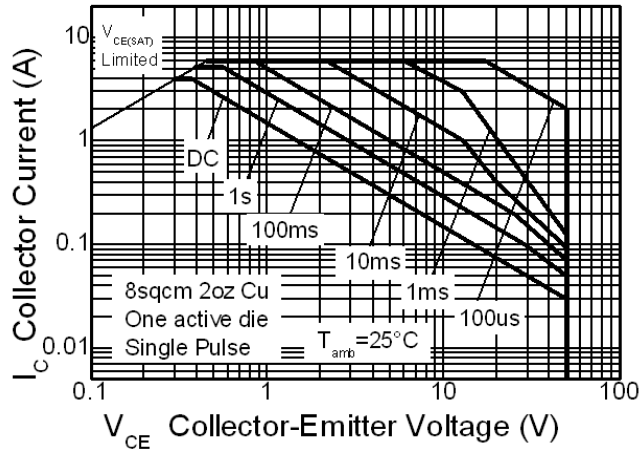

Safe Operating Area

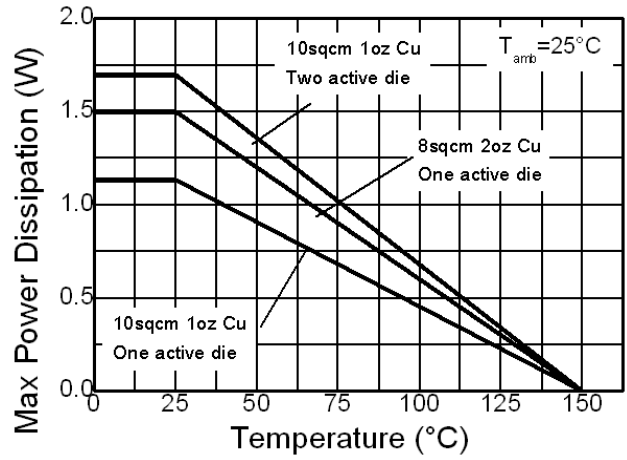

Derating Curve

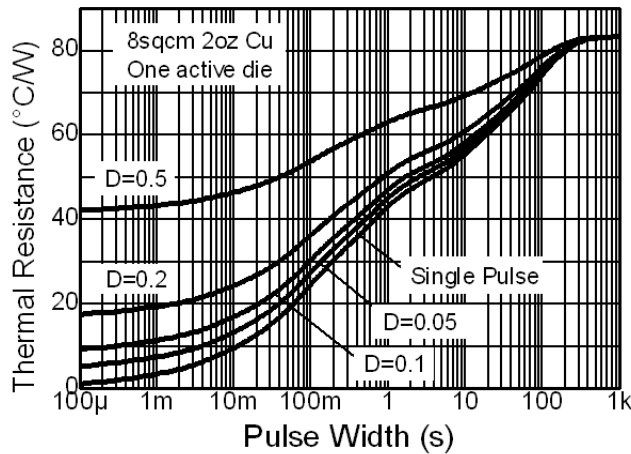

Transient Thermal Impedance

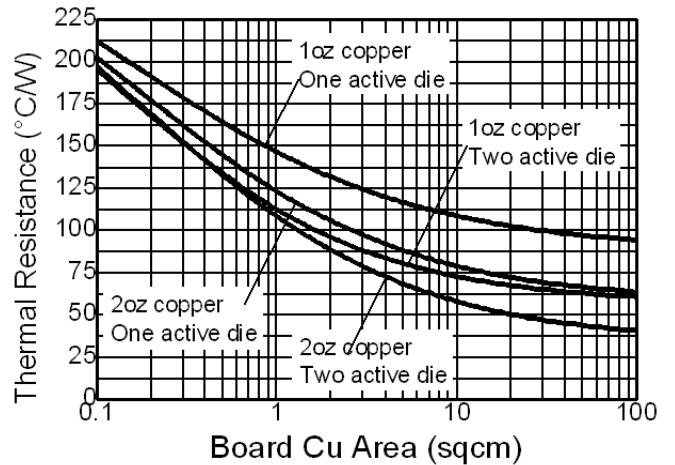

Thermal Resistance v Board Area

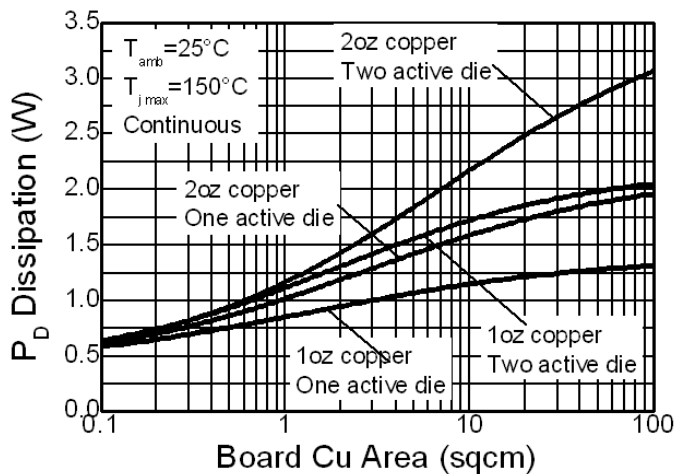

Power Dissipation v Board Area

Electrical Characteristics @T_A = 25°C unless otherwise specified

Characteristic	Symbol	Min	Typ	Max	Unit	Test Condition
Collector-Base Breakdown Voltage	V _{(BR)CBO}	100	190	-	V	I _C = 100μA
Collector-Emitter Breakdown Voltage (Note 10)	V _{(BR)CEO}	50	65	-	V	I _C = 10mA
Emitter-Base Breakdown Voltage	V _{(BR)EBO}	7	8.2	-	V	I _E = 100μA
Collector Cutoff Current	I _{CBO}	-	-	100	nA	V _{CB} = 80V
Emitter Cutoff Current	I _{EBO}	-	-	100	nA	V _{EB} = 6V
Collector Emitter Cutoff Current	I _{CES}	-	-	100	nA	V _{CES} = 40V
Static Forward Current Transfer Ratio (Note 10)	h _{FE}	200	400	-	-	I _C = 10mA, V _{CE} = 2V
		300	450	-	-	I _C = 200mA, V _{CE} = 2V
		200	400	-	-	I _C = 1A, V _{CE} = 2V
		100	225	-	-	I _C = 2A, V _{CE} = 2V
		-	40	-	-	I _C = 6A, V _{CE} = 2V
Collector-Emitter Saturation Voltage (Note 10)	V _{CE(sat)}	-	10	20	mV	I _C = 0.1A, I _B = 10mA
		-	70	100	mV	I _C = 1A, I _B = 50mA
		-	145	200	mV	I _C = 1A, I _B = 10mA
		-	115	220	mV	I _C = 2A, I _B = 50mA
		-	225	300	mV	I _C = 3A, I _B = 100mA
		-	270	320	mV	I _C = 4A, I _B = 200mA
Base-Emitter Turn-On Voltage (Note 10)	V _{BE(on)}	-	0.94	1.00	V	I _C = 4A, V _{CE} = 2V
Base-Emitter Saturation Voltage (Note 10)	V _{BE(sat)}	-	1.00	1.07	V	I _C = 4A, I _B = 200mA
Output Capacitance	C _{obo}	-	12	20	pF	V _{CB} = 10V, f = 1MHz
Transition Frequency	f _T	100	165	-	MHz	V _{CE} = 10V, I _C = 50mA, f = 100MHz
Turn-on Time	t _{on}	-	170	-	ns	V _{CC} = 10V, I _C = 1A
Turn-off Time	t _{off}	-	750	-	ns	I _{B1} = I _{B2} = 10mA

Notes: 10. Measured under pulsed conditions. Pulse width ≤ 300 μs. Duty cycle ≤ 2%

Typical Electrical Characteristics

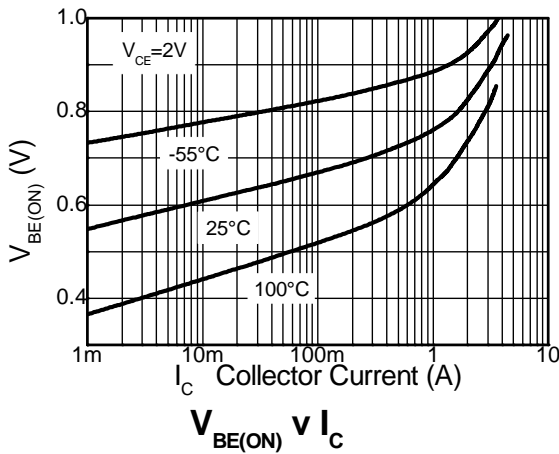
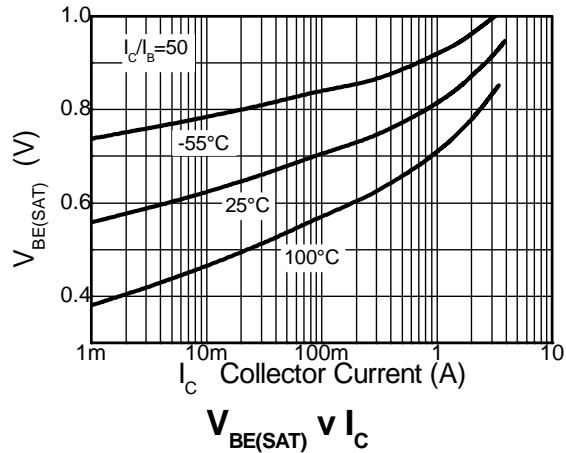
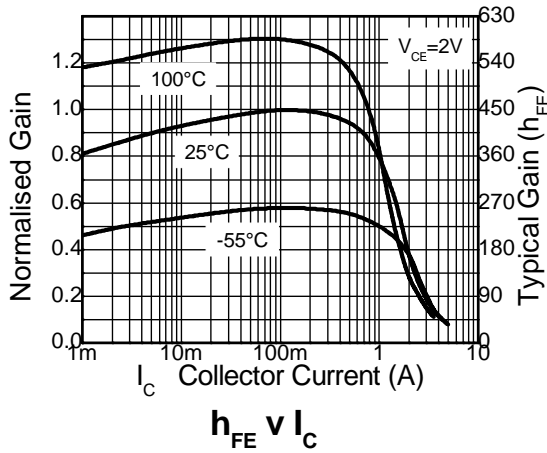
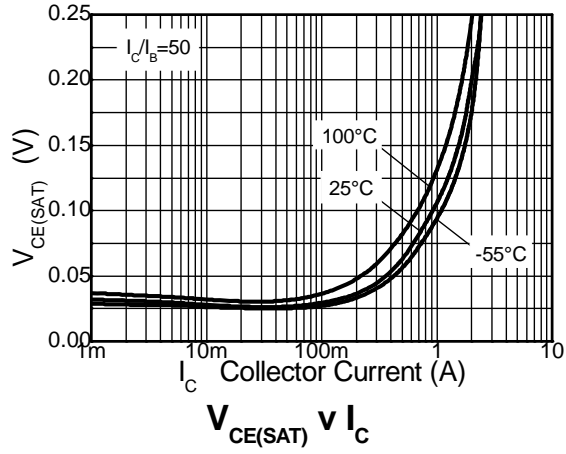
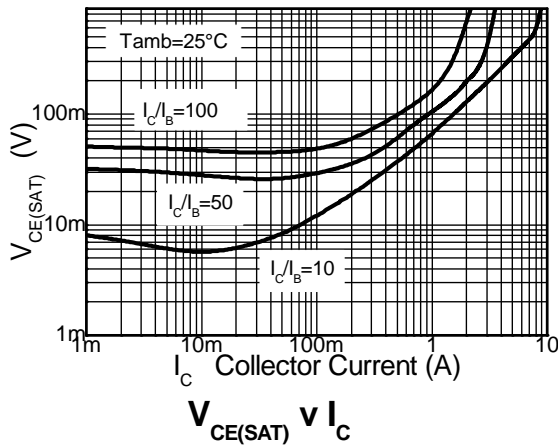

ZXTD619MC

Package Outline Dimensions

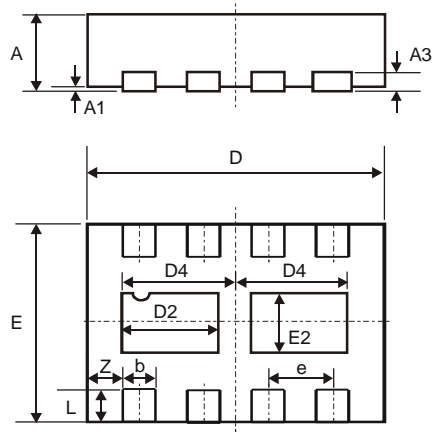

DFN3020B-8			
Dim	Min	Max	Typ
A	0.77	0.83	0.80
A1	0	0.05	0.02
A3	-	-	0.15
b	0.25	0.35	0.30
D	2.95	3.075	3.00
D2	0.82	1.02	0.92
D4	1.01	1.21	1.11
e	-	-	0.65
E	1.95	2.075	2.00
E2	0.43	0.63	0.53
L	0.25	0.35	0.30
Z	-	-	0.375
All Dimensions in mm			

Suggested Pad Layout

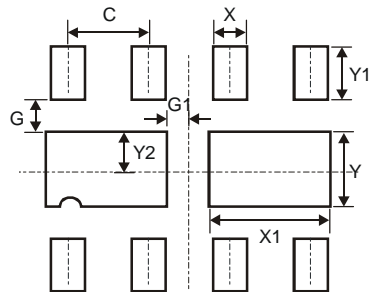

Dimensions	Value (in mm)
C	0.650
G	0.285
G1	0.090
X	0.400
X1	1.120
Y	0.730
Y1	0.500
Y2	0.365

IMPORTANT NOTICE

DIODES INCORPORATED MAKES NO WARRANTY OF ANY KIND, EXPRESS OR IMPLIED, WITH REGARDS TO THIS DOCUMENT, INCLUDING, BUT NOT LIMITED TO, THE IMPLIED WARRANTIES OF MERCHANTABILITY AND FITNESS FOR A PARTICULAR PURPOSE (AND THEIR EQUIVALENTS UNDER THE LAWS OF ANY JURISDICTION).

Diodes Incorporated and its subsidiaries reserve the right to make modifications, enhancements, improvements, corrections or other changes without further notice to this document and any product described herein. Diodes Incorporated does not assume any liability arising out of the application or use of this document or any product described herein; neither does Diodes Incorporated convey any license under its patent or trademark rights, nor the rights of others. Any Customer or user of this document or products described herein in such applications shall assume all risks of such use and will agree to hold Diodes Incorporated and all the companies whose products are represented on Diodes Incorporated website, harmless against all damages.

Diodes Incorporated does not warrant or accept any liability whatsoever in respect of any products purchased through unauthorized sales channel. Should Customers purchase or use Diodes Incorporated products for any unintended or unauthorized application, Customers shall indemnify and hold Diodes Incorporated and its representatives harmless against all claims, damages, expenses, and attorney fees arising out of, directly or indirectly, any claim of personal injury or death associated with such unintended or unauthorized application.

Products described herein may be covered by one or more United States, international or foreign patents pending. Product names and markings noted herein may also be covered by one or more United States, international or foreign trademarks.

LIFE SUPPORT

Diodes Incorporated products are specifically not authorized for use as critical components in life support devices or systems without the express written approval of the Chief Executive Officer of Diodes Incorporated. As used herein:

A. Life support devices or systems are devices or systems which:

1. are intended to implant into the body, or
2. support or sustain life and whose failure to perform when properly used in accordance with instructions for use provided in the labeling can be reasonably expected to result in significant injury to the user.

B. A critical component is any component in a life support device or system whose failure to perform can be reasonably expected to cause the failure of the life support device or to affect its safety or effectiveness.

Customers represent that they have all necessary expertise in the safety and regulatory ramifications of their life support devices or systems, and acknowledge and agree that they are solely responsible for all legal, regulatory and safety-related requirements concerning their products and any use of Diodes Incorporated products in such safety-critical, life support devices or systems, notwithstanding any devices- or systems-related information or support that may be provided by Diodes Incorporated. Further, Customers must fully indemnify Diodes Incorporated and its representatives against any damages arising out of the use of Diodes Incorporated products in such safety-critical, life support devices or systems.

Copyright © 2011, Diodes Incorporated

www.diodes.com

Mouser Electronics

Authorized Distributor

Click to View Pricing, Inventory, Delivery & Lifecycle Information:

[Diodes Incorporated:](#)

[ZXTD619MCTA](#)