

Product Summary

$V_{(BR)DSS}$	$R_{DS(on) \max}$	I_D $T_A = +25^\circ\text{C}$
-50V	10Ω @ $V_{GS} = -5\text{V}$	-130mA

Description

This MOSFET has been designed to minimize the on-state resistance ($R_{DS(on)}$) and yet maintain superior switching performance, making it ideal for high efficiency power management applications.

Applications

- General Purpose Interfacing Switch
- Power Management Functions
- Analog Switch

Features and Benefits

- Low On-Resistance
- Low Gate Threshold Voltage
- Low Input Capacitance
- Fast Switching Speed
- Low Input/Output Leakage
- **Totally Lead-Free & Fully RoHS Compliant (Notes 1 & 2)**
- **Halogen and Antimony Free. "Green" Device (Note 3)**
- **Qualified to AEC-Q101 Standards for High Reliability**

Mechanical Data

- Case: SOT23
- Case Material: UL Flammability Classification Rating 94V-0
- Moisture Sensitivity: Level 1 per J-STD-020
- Terminals: Matte Tin Finish (Lead Free Plating) Solderable per MIL-STD-202, Method 208 **Ⓔ**
- Terminal Connections: See Diagram
- Weight: 0.008 grams (approximate)



Top View

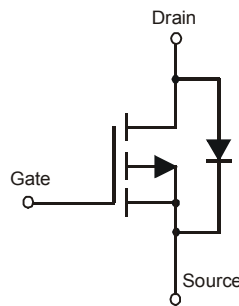

Equivalent Circuit

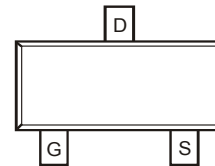

Top View

Ordering Information (Note 4)

Part Number	Qualification	Case	Packaging
BSS84-7-F	Commercial	SOT23	3000/Tape & Reel
BSS84Q-7-F	Automotive	SOT23	3000/Tape & Reel
BSS84-13-F	Commercial	SOT23	10000/Tape & Reel
BSS84Q-13-F	Automotive	SOT23	10000/Tape & Reel

- Notes:
1. No purposely added lead. Fully EU Directive 2002/95/EC (RoHS) & 2011/65/EU (RoHS 2) compliant.
 2. See http://www.diodes.com/quality/lead_free.html for more information about Diodes Incorporated's definitions of Halogen- and Antimony-free, "Green" and Lead-free.
 3. Halogen- and Antimony-free "Green" products are defined as those which contain <900ppm bromine, <900ppm chlorine (<1500ppm total Br + Cl) and <1000ppm antimony compounds.
 4. For packaging details, go to our website at <http://www.diodes.com/products/packages.html>

Marking Information

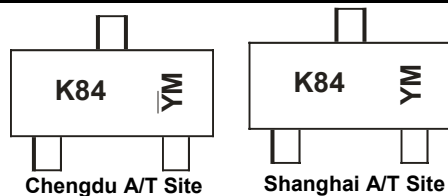

K84 = Product Type Marking Code
 YM = Date Code Marking for SAT (Shanghai Assembly/ Test site)
 YM = Date Code Marking for CAT (Chengdu Assembly/ Test site)
 Y or \bar{Y} = Year (ex: A = 2013)
 M = Month (ex: 9 = September)

Date Code Key

Year	1998	1999	2000	2001	2002	2003	2004	...	2011	2012	2013	2014	2015	2016	2017
Code	J	K	L	M	N	P	R	...	Y	Z	A	B	C	D	E

Month	Jan	Feb	Mar	Apr	May	Jun	Jul	Aug	Sep	Oct	Nov	Dec
Code	1	2	3	4	5	6	7	8	9	O	N	D

Maximum Ratings (@T_A = +25°C, unless otherwise specified.)

Characteristic	Symbol	Value	Units
Drain-Source Voltage	V _{DSS}	-50	V
Drain-Gate Voltage R _{GS} ≤ 20KΩ	V _{DGR}	-50	V
Gate-Source Voltage	V _{GSS}	±20	V
Drain Current (Note 5)	I _D	-130	mA
Pulsed Drain Current	I _{DM}	-1.2	A

Thermal Characteristics (@T_A = +25°C, unless otherwise specified.)

Characteristic	Symbol	Value	Units
Total Power Dissipation (Note 5)	P _D	300	mW
Thermal Resistance, Junction to Ambient	R _{θJA}	417	°C/W
Operating and Storage Temperature Range	T _J , T _{STG}	-55 to +150	°C

Electrical Characteristics (@T_A = +25°C, unless otherwise specified.)

Characteristic	Symbol	Min	Typ	Max	Unit	Test Condition
OFF CHARACTERISTICS (Note 6)						
Drain-Source Breakdown Voltage	BV _{DSS}	-50	—	—	V	V _{GS} = 0V, I _D = -250μA
Zero Gate Voltage Drain Current	I _{DSS}	—	—	-1	μA	V _{DS} = -50V, V _{GS} = 0V, T _J = +25°C
		—	—	-2	μA	V _{DS} = -50V, V _{GS} = 0V, T _J = +125°C
		—	—	-100	nA	V _{DS} = -25V, V _{GS} = 0V, T _J = +25°C
Gate-Body Leakage	I _{GSS}	—	—	±10	nA	V _{GS} = ±20V, V _{DS} = 0V
ON CHARACTERISTICS (Note 6)						
Gate Threshold Voltage	V _{GS(th)}	-0.8	—	-2.0	V	V _{DS} = V _{GS} , I _D = -1mA
Static Drain-Source On-Resistance	R _{DS(ON)}	—	—	10	Ω	V _{GS} = -5V, I _D = -0.100A
Forward Transconductance	g _{FS}	0.05	—	—	S	V _{DS} = -25V, I _D = -0.1A
DYNAMIC CHARACTERISTICS (Note 7)						
Input Capacitance	C _{iss}	—	—	45	pF	V _{DS} = -25V, V _{GS} = 0V, f = 1.0MHz
Output Capacitance	C _{oss}	—	—	25	pF	
Reverse Transfer Capacitance	C _{rss}	—	—	12	pF	
SWITCHING CHARACTERISTICS (Note 7)						
Turn-On Delay Time	t _{D(ON)}	—	10	—	ns	V _{DD} = -30V, I _D = -0.27A,
Turn-Off Delay Time	t _{D(OFF)}	—	18	—	ns	R _{GEN} = 50Ω, V _{GS} = -10V

- Notes:
- Device mounted on FR-4 PCB, 1 inch x 0.85 inch x 0.062 inch; pad layout as shown on Diodes Inc. suggested pad layout document AP02001, which can be found on our website at <http://www.diodes.com>.
 - Short duration pulse test used to minimize self-heating effect.
 - Guaranteed by design. Not subject to production testing

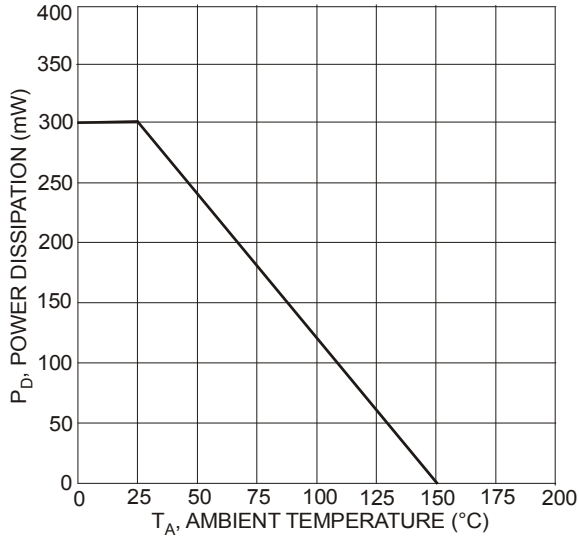

Fig. 1 Max Power Dissipation vs. Ambient Temperature

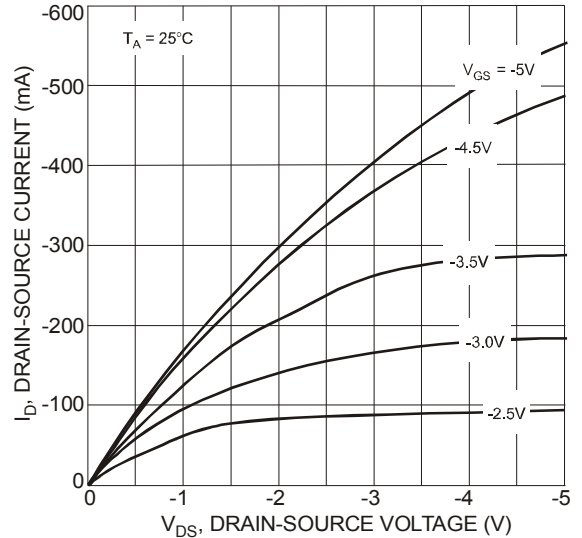

Fig. 2 Drain-Source Current vs. Drain-Source Voltage

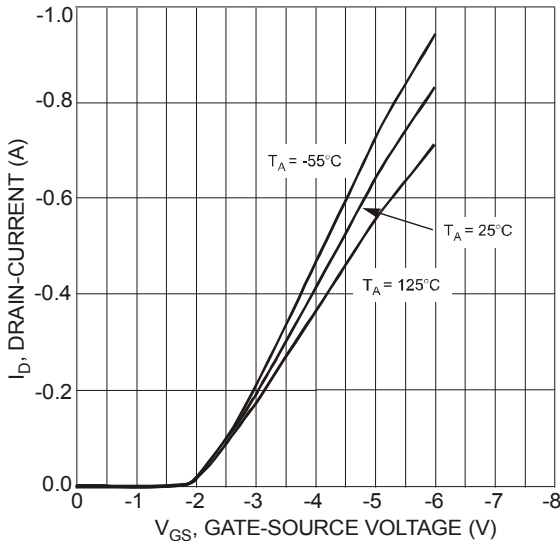

Fig. 3 Drain-Current vs. Gate-Source Voltage

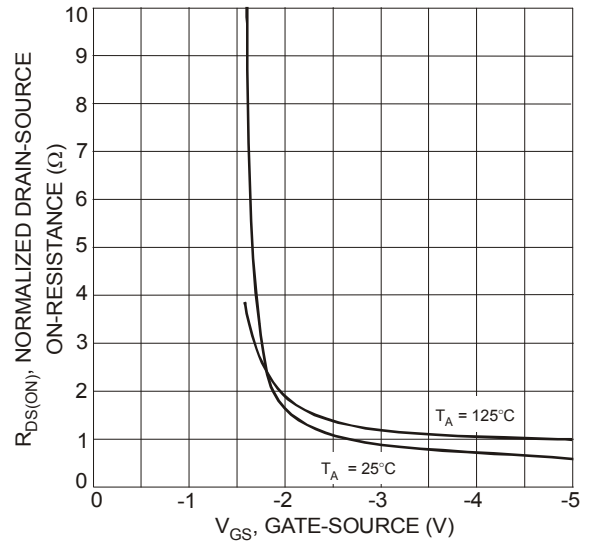

Fig. 4 On-Resistance vs. Gate-Source Voltage

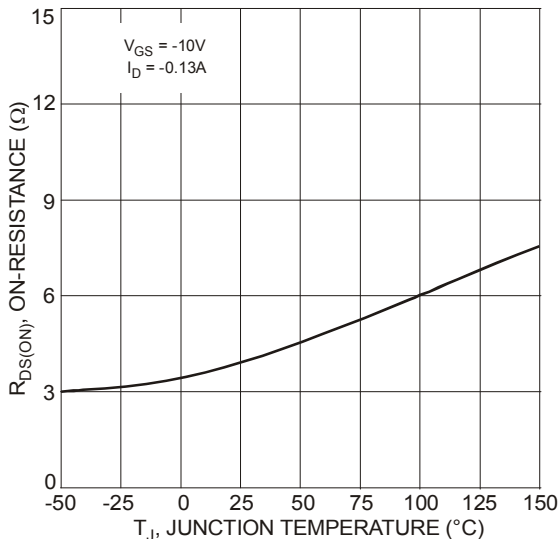

Fig. 5 On-Resistance vs. Junction Temperature

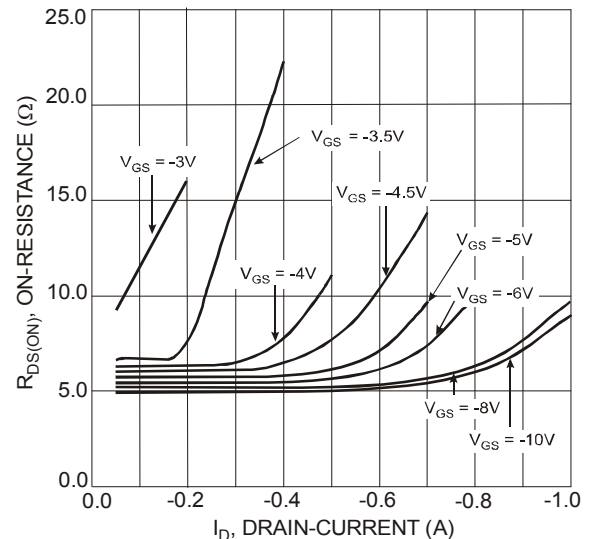
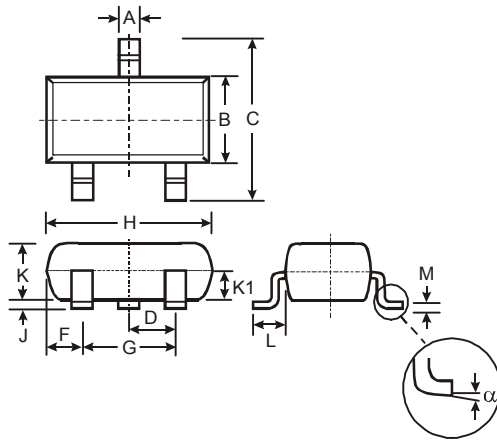

Fig. 6 On-Resistance vs. Drain-Current

Package Outline Dimensions

Please see AP02002 at <http://www.diodes.com/datasheets/ap02002.pdf> for latest version.



SOT23			
Dim	Min	Max	Typ
A	0.37	0.51	0.40
B	1.20	1.40	1.30
C	2.30	2.50	2.40
D	0.89	1.03	0.915
F	0.45	0.60	0.535
G	1.78	2.05	1.83
H	2.80	3.00	2.90
J	0.013	0.10	0.05
K	0.903	1.10	1.00
K1	-	-	0.400
L	0.45	0.61	0.55
M	0.085	0.18	0.11
α	0°	8°	-
All Dimensions in mm			

Suggested Pad Layout

Please see AP02001 at <http://www.diodes.com/datasheets/ap02001.pdf> for the latest version.

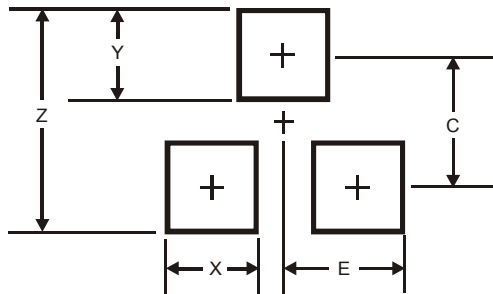

Dimensions	Value (in mm)
Z	2.9
X	0.8
Y	0.9
C	2.0
E	1.35

IMPORTANT NOTICE

DIODES INCORPORATED MAKES NO WARRANTY OF ANY KIND, EXPRESS OR IMPLIED, WITH REGARDS TO THIS DOCUMENT, INCLUDING, BUT NOT LIMITED TO, THE IMPLIED WARRANTIES OF MERCHANTABILITY AND FITNESS FOR A PARTICULAR PURPOSE (AND THEIR EQUIVALENTS UNDER THE LAWS OF ANY JURISDICTION).

Diodes Incorporated and its subsidiaries reserve the right to make modifications, enhancements, improvements, corrections or other changes without further notice to this document and any product described herein. Diodes Incorporated does not assume any liability arising out of the application or use of this document or any product described herein; neither does Diodes Incorporated convey any license under its patent or trademark rights, nor the rights of others. Any Customer or user of this document or products described herein in such applications shall assume all risks of such use and will agree to hold Diodes Incorporated and all the companies whose products are represented on Diodes Incorporated website, harmless against all damages.

Diodes Incorporated does not warrant or accept any liability whatsoever in respect of any products purchased through unauthorized sales channel. Should Customers purchase or use Diodes Incorporated products for any unintended or unauthorized application, Customers shall indemnify and hold Diodes Incorporated and its representatives harmless against all claims, damages, expenses, and attorney fees arising out of, directly or indirectly, any claim of personal injury or death associated with such unintended or unauthorized application.

Products described herein may be covered by one or more United States, international or foreign patents pending. Product names and markings noted herein may also be covered by one or more United States, international or foreign trademarks.

This document is written in English but may be translated into multiple languages for reference. Only the English version of this document is the final and determinative format released by Diodes Incorporated.

LIFE SUPPORT

Diodes Incorporated products are specifically not authorized for use as critical components in life support devices or systems without the express written approval of the Chief Executive Officer of Diodes Incorporated. As used herein:

A. Life support devices or systems are devices or systems which:

1. are intended to implant into the body, or
2. support or sustain life and whose failure to perform when properly used in accordance with instructions for use provided in the labeling can be reasonably expected to result in significant injury to the user.

B. A critical component is any component in a life support device or system whose failure to perform can be reasonably expected to cause the failure of the life support device or to affect its safety or effectiveness.

Customers represent that they have all necessary expertise in the safety and regulatory ramifications of their life support devices or systems, and acknowledge and agree that they are solely responsible for all legal, regulatory and safety-related requirements concerning their products and any use of Diodes Incorporated products in such safety-critical, life support devices or systems, notwithstanding any devices- or systems-related information or support that may be provided by Diodes Incorporated. Further, Customers must fully indemnify Diodes Incorporated and its representatives against any damages arising out of the use of Diodes Incorporated products in such safety-critical, life support devices or systems.

Copyright © 2013, Diodes Incorporated

www.diodes.com

Mouser Electronics

Authorized Distributor

Click to View Pricing, Inventory, Delivery & Lifecycle Information:

[Diodes Incorporated:](#)

[BSS84-7-F](#)