



Is Now Part of



ON Semiconductor®

To learn more about ON Semiconductor, please visit our website at
www.onsemi.com

ON Semiconductor and the ON Semiconductor logo are trademarks of Semiconductor Components Industries, LLC dba ON Semiconductor or its subsidiaries in the United States and/or other countries. ON Semiconductor owns the rights to a number of patents, trademarks, copyrights, trade secrets, and other intellectual property. A listing of ON Semiconductor's product/patent coverage may be accessed at www.onsemi.com/site/pdf/Patent-Marking.pdf. ON Semiconductor reserves the right to make changes without further notice to any products herein. ON Semiconductor makes no warranty, representation or guarantee regarding the suitability of its products for any particular purpose, nor does ON Semiconductor assume any liability arising out of the application or use of any product or circuit, and specifically disclaims any and all liability, including without limitation special, consequential or incidental damages. Buyer is responsible for its products and applications using ON Semiconductor products, including compliance with all laws, regulations and safety requirements or standards, regardless of any support or applications information provided by ON Semiconductor. "Typical" parameters which may be provided in ON Semiconductor data sheets and/or specifications can and do vary in different applications and actual performance may vary over time. All operating parameters, including "Typicals" must be validated for each customer application by customer's technical experts. ON Semiconductor does not convey any license under its patent rights nor the rights of others. ON Semiconductor products are not designed, intended, or authorized for use as a critical component in life support systems or any FDA Class 3 medical devices or medical devices with a same or similar classification in a foreign jurisdiction or any devices intended for implantation in the human body. Should Buyer purchase or use ON Semiconductor products for any such unintended or unauthorized application, Buyer shall indemnify and hold ON Semiconductor and its officers, employees, subsidiaries, affiliates, and distributors harmless against all claims, costs, damages, and expenses, and reasonable attorney fees arising out of, directly or indirectly, any claim of personal injury or death associated with such unintended or unauthorized use, even if such claim alleges that ON Semiconductor was negligent regarding the design or manufacture of the part. ON Semiconductor is an Equal Opportunity/Affirmative Action Employer. This literature is subject to all applicable copyright laws and is not for resale in any manner.

FAN5776

Synchronous Boost and Series / Parallel 10-LED Driver

Features

- Synchronous Current-Mode Boost Converter
- Drives up to 10 LEDs at 25 mA Each in a Configuration of 5 Strings of 2 LEDs in Series
- 5 LED Outputs: High-Side Current Sources
- Two Default Groups of 3x2-LED Channels and 2x2-LED Channels with Individual Enable and PWM Dimming Control to Support Various Lighting Applications, such as:
 - Backlighting of Dual-LCD Displays, LCD Display Plus Keypad Illumination
- Boost PFM Mode Maximizes Efficiency Under Light Loads
- 2.3 V to 5.5 V Input Voltage Range
- 1.8 MHz Switching Frequency
- Input Under-Voltage Lockout (UVLO)
- Output Over-Voltage Protection (OVP)
- Short-Circuit and Thermal Shutdown (TSD) Protection
- 12-Bump, 0.4 mm Pitch, 1.42 x 1.66 x 0.50 mm WLCSP

Applications

- Mid-and Large-Size LCD Modules
- Cellular Mobile Handsets, Smart Phones
- Smartbooks, Netbooks, MIDs
- Pocket PCs
- WLAN DC-DC Converter Modules
- PDA, DSC, PMP, and MP3 Players

Description

The FAN5776 is a synchronous, constant-current LED driver capable of efficiently driving up to ten LEDs in a five-string, two-series LEDs per string configuration. Optimized for small form-factor applications, the 1.8 MHz switching frequency allows the use of tiny chip inductors and capacitors.

For safety, the device features integrated over-voltage, short-circuit, and thermal shutdown protections. In addition, input under-voltage lockout protection is triggered if the battery voltage is too low.

The FAN5776 is comprised of low-dropout, high-side current sources, enabling a high efficiency delivery of power from the battery to the LEDs. The LED current control is established with a series RSET resistor, which is connected between the internal voltage reference on the chip and ground.

During operation, FAN5776 holds the boost regulator's voltage on C_{OUT} during the off cycle of the PWM dimming, which helps minimize audible noise.

The FAN5776 is available in a very low profile, small-form-factors 1.42 x 1.66 x 0.50 mm, 12-bump WLCSP package that is "green" and RoHS compliant.

Ordering Information

Part Number	Temperature Range	Package	Packing
FAN5776UCX	-40 to 85°C	12-Bump, Wafer-Level Chip-Scale Package (WLCSP) 1.42 x 1.66 x 0.50 mm, 0.40 mm Pitch	Tape and Reel

Block Diagram

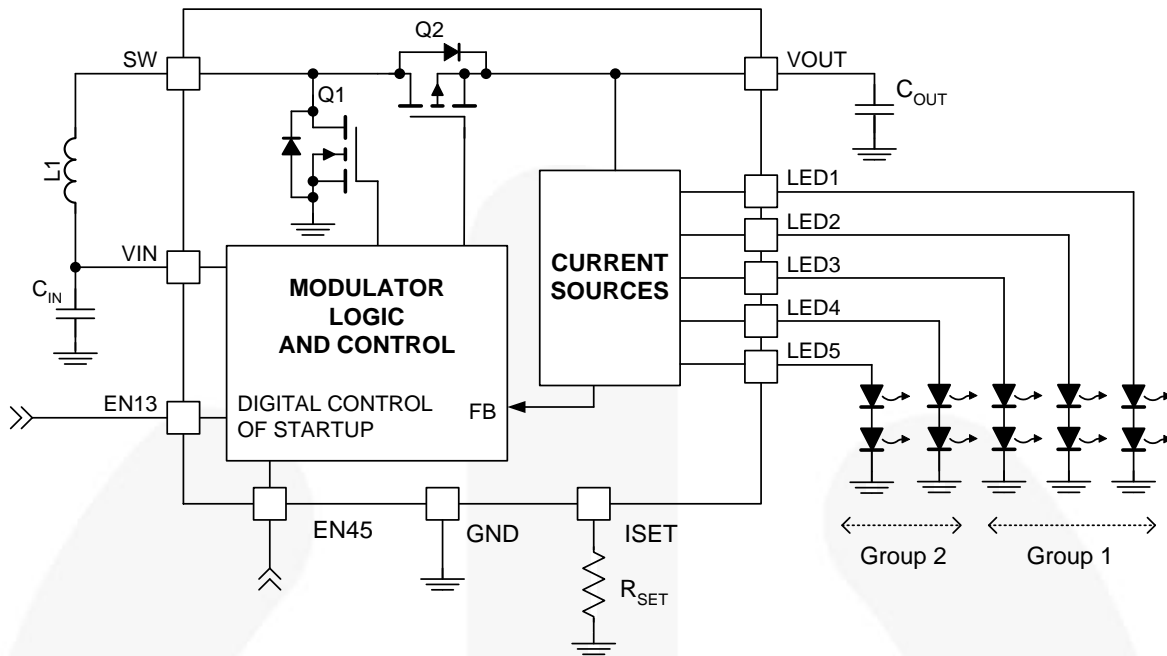

Figure 1. Typical Application Block Diagram

Table 1. Recommended External Components

Component	Description	Vendor	Parameter	Min.	Typ.	Max.	Units
L1	$I_{L1} = 500 \text{ mA}$	Various	L	2.45	4.70		μH
			R			0.30	Ω
R_{SET}	1% or Better	Various	R	20		200	$\text{k}\Omega$
C_{OUT}	10 μF X5R or Better	Murata GRM219R61A116UE82	C	4.2	10.0	20.0	μF
C_{IN}	2.2 μF X5R or Better	Murata GRM155R61A225KE95	C		2.2		μF

Pin Configuration

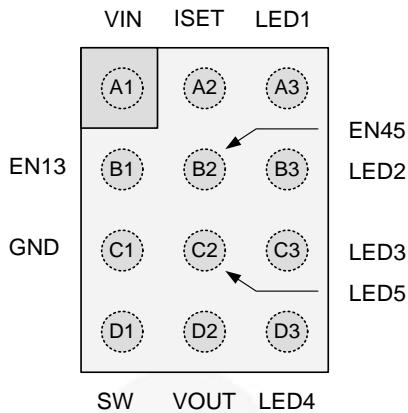

Figure 2. Top View (Bumps Face Down)

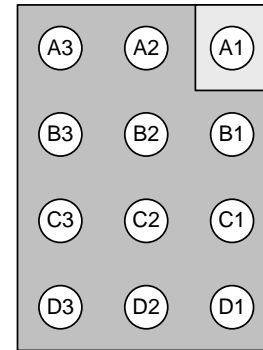

Figure 3. Bottom View (Bumps Face Up)

Pin Definitions

Pin #	Name	Description
A1	VIN	Input voltage
A2	ISET	The LED current is set by tying this pin through the resistor, R_{SET} , to GND. The resistor value sets the current for the LED strings.
A3	LED1	LED string #1 output
B1	EN13	Enable/PWM pin for LED1, LED2, and LED3. A logic LOW on this pin turns off the LED drivers in LED1, LED2, and LED3. The IC goes to shutdown 30 ms after both enable pins (EN13 and EN45) are set LOW. It is connected to an internal pull-down resistor of 250 k Ω .
B2	EN45	Enable/PWM pin for LED4 and LED5. A logic LOW on this pin turns off the LED drivers in LED4 and LED5. The IC goes to shutdown 30 ms after both enable pins (EN13 and EN45) are set LOW. It is connected to an internal pull-down resistor of 250 k Ω .
B3	LED2	LED string #2 output
C1	GND	Ground. All power and analog signals are referenced to this pin.
C2	LED5	LED string #5 output
C3	LED3	LED string #3 output
D1	SW	Switching Node. Tie inductor L1 from VIN to this pin.
D2	VOUT	Boost output voltage used to supply the LED current sources. This voltage is regulated to the minimum value required to ensure adequate voltage across all active LED current sources.
D3	LED4	LED string #4 output

Absolute Maximum Ratings

Stresses exceeding the absolute maximum ratings may damage the device. The device may not function or be operable above the recommended operating conditions and stressing the parts to these levels is not recommended. In addition, extended exposure to stresses above the recommended operating conditions may affect device reliability. The absolute maximum ratings are stress ratings only.

Symbol	Parameter	Min.	Max.	Unit
V_{IN}	Supply Voltage	-0.3	6.0	V
V_{ISET}	ISET Voltage	-0.3	$V_{IN} + 0.3$	V
V_{EN}	EN13 and EN45 Pin Maximum Voltage	-0.3	6.0	V
V_{OVP}	VOUT, SW, and LEDx Drive Pins Maximum Voltage	-0.3	11.0	V
ESD	Electrostatic Discharge Protection Level	Human Body Model per JESD22-A114	2	kV
		Charged Device Model per JESD22-C101	1	
T_A	Operating Ambient Temperature	-40	+85	°C
T_J	Junction Temperature	-40	+150	°C
T_{STG}	Storage Temperature	-65	+150	°C
T_L	Lead Soldering Temperature, 10 Seconds		+260	°C

Recommended Operating Conditions

The Recommended Operating Conditions table defines the conditions for actual device operation. Recommended operating conditions are specified to ensure optimal performance to the datasheet specifications. Fairchild does not recommend exceeding them or designing to absolute maximum ratings.

Symbol	Parameter	Min.	Typ.	Max.	Unit
V_{IN}	V_{IN} Supply Voltage	2.3	3.7	5.5	V
V_{OUT}	V_{OUT} Voltage ⁽¹⁾	3.5		8.5	V
$I_{LED(FS)}$	Full Scale LED Current per Channel	2.5		25.0	mA
T_A	Ambient Temperature	-40		+85	°C
T_J	Junction Temperature	-40		+125	°C

Note:

- The minimum V_{OUT} must be 3.5 V to guarantee a maximum LED current of 25 mA for each LED pin. Otherwise the device internally sets a minimum V_{OUT} to $V_{IN} + 0.3$ V, and the LED driver dropout is increased accordingly (if LED $V_F < V_{IN}$, where $V_F = V_{OUT} - 0.3$ V).

Thermal Properties

Junction-to-ambient thermal resistance is a function of application and board layout. This data is measured with four-layer 2s2p boards in accordance to JEDEC standard JESD51. Special attention must be paid not to exceed junction temperature $T_{J(max)}$ at a given ambient temperature T_A .

Symbol	Parameter	Min.	Typ.	Max.	Unit
θ_{JA}	Junction-to-Ambient Thermal Resistance		90		°C/W

Electrical Specifications

Unless otherwise specified: $V_{IN} = 2.3\text{ V to }5.5\text{ V}$, $T_A = -40^\circ\text{C to }+85^\circ\text{C}$, and EN13 and EN45 = "1." Typical values are $V_{IN} = 3.7\text{ V}$, $T_A = 25^\circ\text{C}$, $V_{OUT} = 6.8\text{ V}$, $I_{LED1-5} = 20\text{ mA}$. Circuit and components are according to Figure 1.

Symbol	Parameter	Condition	Min.	Typ.	Max.	Unit
Power Supplies						
I_{SD}	Shutdown Current	Device Disabled, (EN13 = EN45 = "0"), $V_{IN} = 2.3\text{ V to }4.5\text{ V}$		0.1	4.0	μA
V_{UVLO}	Under-Voltage Lockout Threshold	Rising V_{IN}		2.1	2.2	V
		Falling V_{IN}	1.8	1.9		V
V_{UVHYST}	Under-Voltage Lockout Hysteresis			200		mV
Oscillator						
f_{SW}	Frequency	PWM Mode CCM		1.8		MHz
Boost Regulator						
I_{LIM-PK}	Peak Switch Current Limit ⁽²⁾	Open Loop, $V_{IN} = 2.5\text{ V to }5.5\text{ V}$	445	525	640	mA
$I_{SOFT-PK}$	Soft-Start Peak Switch Current	Open Loop		250		mA
I_{LOAD}	Maximum Continuous Output Current ⁽³⁾	$V_{IN} > 2.5\text{ V}$	100			mA
LED Current Driver Characteristics						
$\Delta I_{LED}/I_{LED}$	Line Transient Response to V_{IN} Variations ⁽³⁾	Relative Response to 350 mV Pulses			10	%
		Response to 350 mV Pulses Integrated Over 20 ms Period			1	
V_{LED_DO}	LED Driver Drop-Out Voltage ⁽⁵⁾			290		mV
f_{PWM}	LED PWM Frequency ⁽³⁾		100		800	Hz
I_{LED_MATCH}	LED Current Matching	Variation between Different $I_{LED1} - I_{LED5}$ Currents. Matching LED Pin Voltage Difference < 250 mV ⁽⁴⁾	$I_{LED} = 2.5\text{ mA to }10\text{ mA}$	2.0	5.0	%
			$I_{LED} = 10\text{ mA to }25\text{ mA}$	1.0	3.5	
$I_{LINEARITY}$	LED Current Linearity ⁽³⁾	$1/255 \leq \text{PWM} \leq 24/255$, 300 Hz $\text{PWM} \geq 25/255$, 300 Hz			10	%
					2	
I_{LED}	Absolute LED Current Accuracy	LED1 – LED5	$I_{LED} = 2.5\text{ mA to }5\text{ mA}$		15.0	%
			$I_{LED} = 5\text{ mA to }25\text{ mA}$		7.5	
I_{LED_RIPPLE}	Peak-to-Peak LED Current Ripple ⁽³⁾	$V_{LED_DO} \leq 0.6\text{ V}$ (Typical 0.29 V), $f_{PWM} = 300\text{ Hz}$, Measurement BW = 10 MHz		0.4	1.2	mA_{P-P}
$I_{LEAKAGE}$	LED Driver Leakage	In OFF State			0.5	μA
V_{ISET}	ISET Voltage			1.20		V
Logic Control						
V_{IL}	Logic LOW Threshold				0.5	V
V_{IH}	Logic HIGH Threshold		1.05			V
R_{EN13}	EN13 Pull-Down Resistor			250		$\text{k}\Omega$
R_{EN45}	EN45 Pull-Down Resistor			250		$\text{k}\Omega$

Continued on the following page...

Electrical Specifications

Unless otherwise specified: $V_{IN} = 2.3 \text{ V to } 5.5 \text{ V}$, $T_A = -40^\circ\text{C to } +85^\circ\text{C}$, and EN13 and EN45 = "1." Typical values are $V_{IN} = 3.7 \text{ V}$, $V_{OUT} = 6.8 \text{ V}$, $T_A = 25^\circ\text{C}$, $I_{LED1-5} = 20 \text{ mA}$. Circuit and components are according to Figure 1.

Symbol	Parameter	Condition	Min.	Typ.	Max.	Unit
Protection						
T_{TSD}	Over-Temperature Shutdown			150		$^\circ\text{C}$
T_{HYS}	Over-Temperature Hysteresis			25		$^\circ\text{C}$
$V_{OV-RISE}$	V_{OUT} Over-Voltage Rising Threshold			9.0		V
$V_{OV-FALL}$	V_{OUT} Over-Voltage Falling Threshold		8.25	8.60		V
V_{OV-HYS}	Hysteresis			400		mV
$V_{LED(SC)}$	LED Short Circuit Protection Threshold		0.7	1.0	1.4	V
$I_{LED-SHORT}$	Shorted LED Current	LED Short-Circuit Protection Threshold Tripped			1	μA

Notes:

- In closed loop operation, the inductor current (I_L) is 30 mA to 40 mA greater than I_{LIM-PK} .
- Guaranteed by characterization and design.
- For the LED outputs, the following are determined: the maximum LED current in the group (MAX), the minimum LED current in the group (MIN), and the average LED current of the group (AVG). Two matching numbers are calculated: $(MAX - AVG) / AVG$ and $(AVG - MIN) / AVG$. The larger number of the two (worst case) is considered the matching value for the group. The matching value for a given part is considered to be the highest matching value of the two groups. The typical specification provided is the most likely norm of the matching value for all parts.
- LED driver drop-out voltage is the smallest voltage across all the LED channels.

Typical Characteristics

$V_{IN} = 3.7\text{ V}$, $T_A = 25^\circ\text{C}$, $I_{LED} = 5 \times 20\text{ mA}$, $V_{OUT} = 6.8\text{ V}$, $L_1 = 4.7\text{ }\mu\text{H}$, and $C_{OUT} = 10\text{ }\mu\text{F}$ (unless otherwise specified).

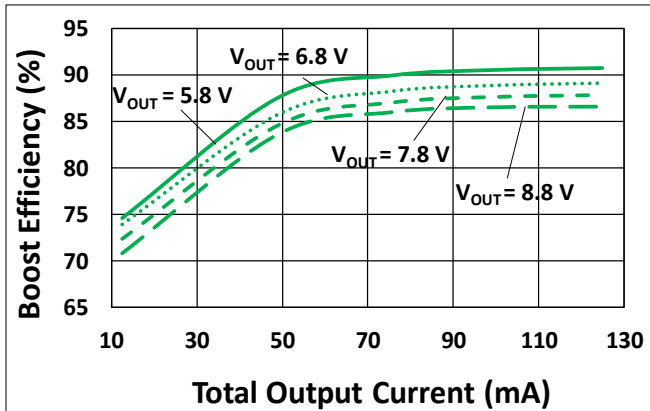

Figure 4. Boost Efficiency vs. Output Current vs. Output Voltage

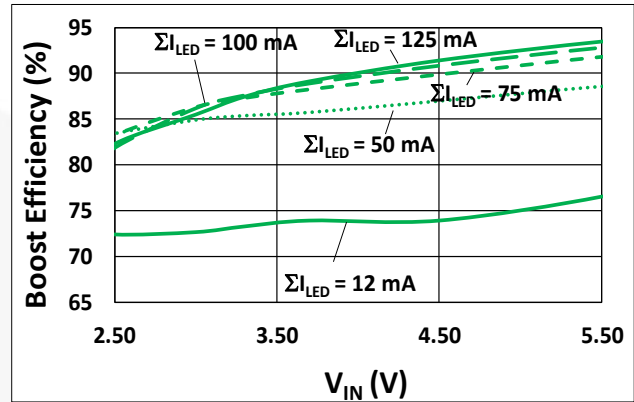

Figure 5. Boost Efficiency vs. Input Voltage vs. Total LED Current

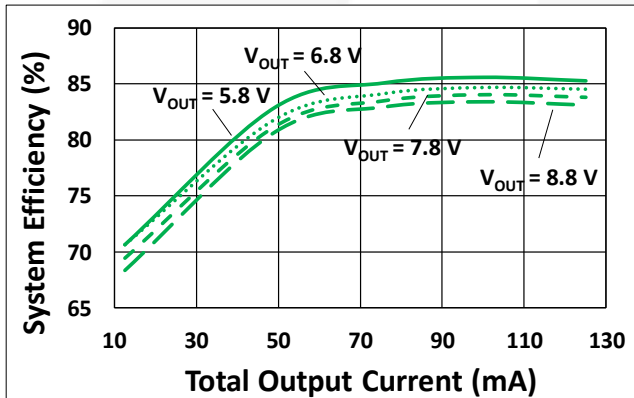

Figure 6. Total Efficiency vs. Output Current vs. Output Voltage

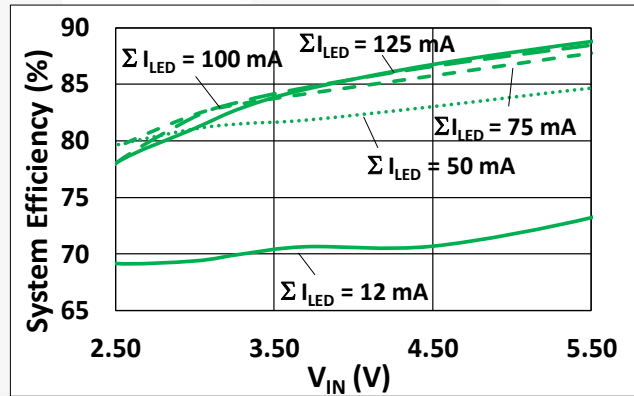

Figure 7. Total Efficiency vs. Input Voltage vs. Total LED Current

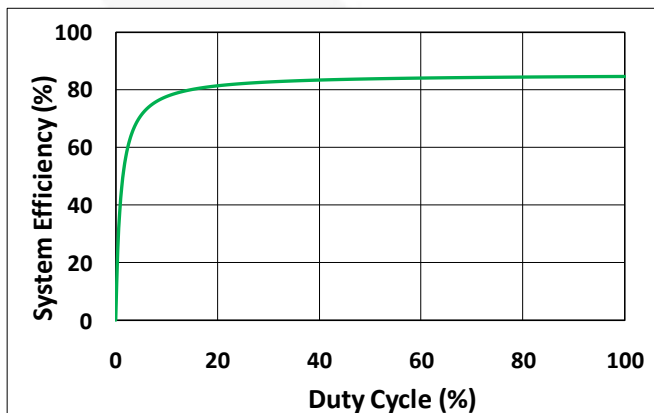

Figure 8. Total Efficiency vs. PWM Duty Cycle, $f_{PWM} = 300\text{ Hz}$

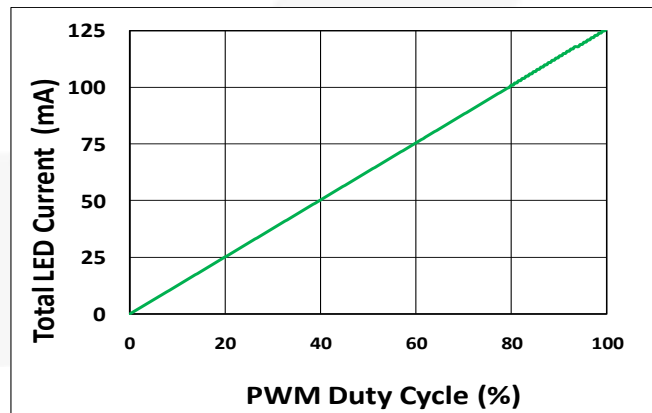

Figure 9. Total LED Current vs. PWM Duty Cycle, $I_{LED} = 5 \times 25\text{ mA}$

Typical Characteristics

$V_{IN} = 3.7\text{ V}$, $T_A = 25^\circ\text{C}$, $I_{LED} = 5 \times 20\text{ mA}$, $V_{OUT} = 6.8\text{ V}$, $L_1 = 4.7\text{ }\mu\text{H}$, $C_{OUT} = 10\text{ }\mu\text{F}$ (unless otherwise specified).

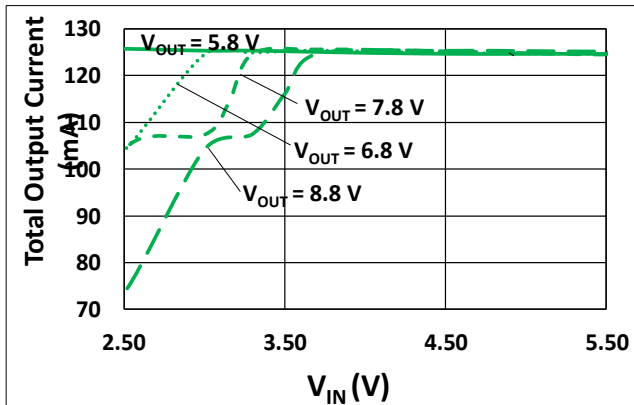

Figure 10. Maximum Output Current ($I_{LED} = 5 \times 25\text{ mA}$) vs. Input Voltage vs. Output Voltage

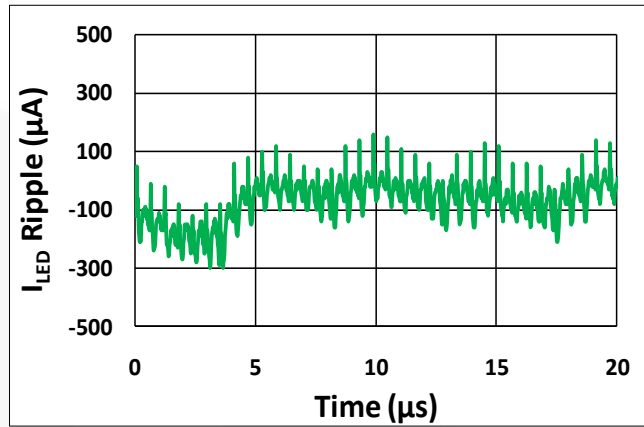

Figure 11. LED Current Ripple

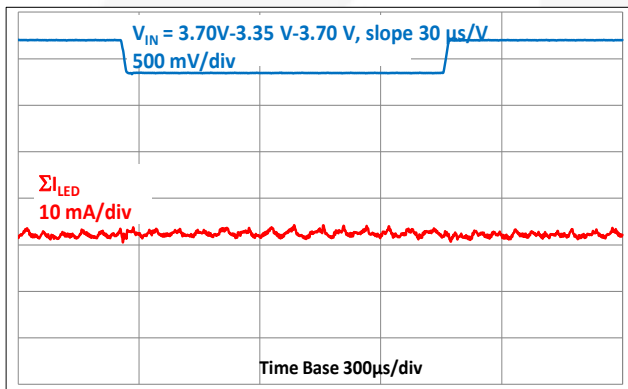

Figure 12. Line Transient Response
 $V_{IN} = 3.70 - 3.35\text{ V} - 3.70\text{ V}$ with $I_{LED} = 5 \times 25\text{ mA}$

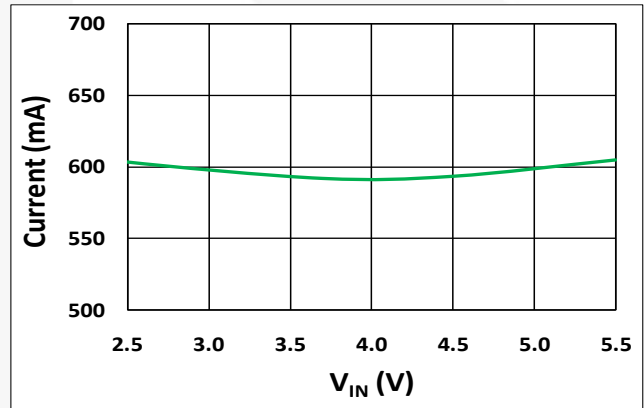

Figure 13. Peak Inductor Current Limit (Closed Loop) vs. Input Voltage

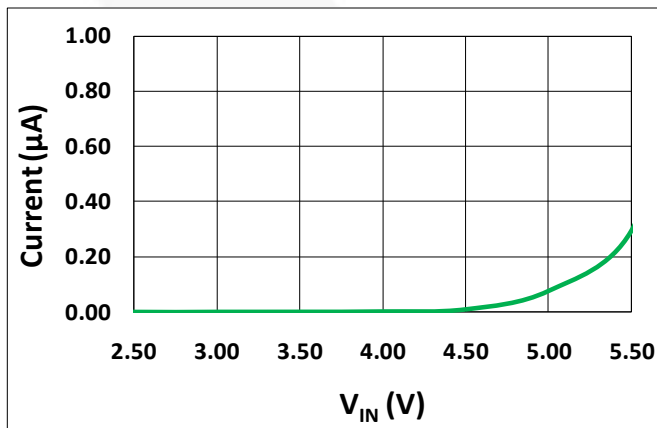

Figure 14. Shutdown Current vs. Input Voltage

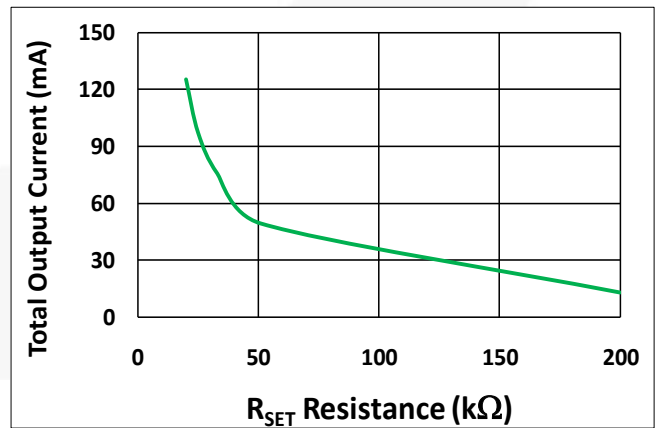

Figure 15. Total Output Current I_{LED} vs. R_{SET} Resistor Value

Typical Characteristics

$V_{IN} = 3.7\text{ V}$, $T_A = 25^\circ\text{C}$, $I_{LED} = 5 \times 20\text{ mA}$, $V_{OUT} = 6.8\text{ V}$, $L1 = 4.7\text{ }\mu\text{H}$, $C_{OUT} = 10\text{ }\mu\text{F}$ (unless otherwise specified).

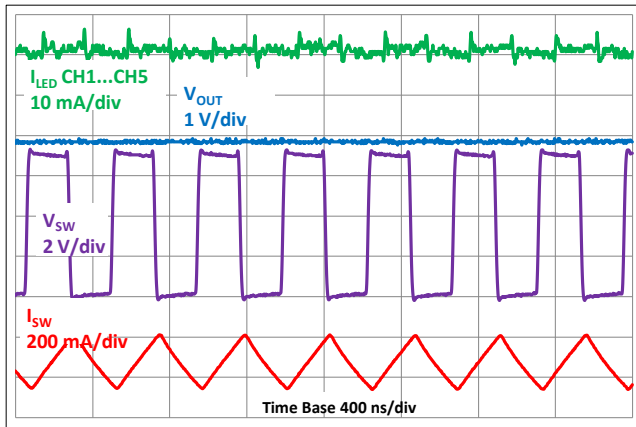

Figure 16. Switch Waveform (V_{OUT} , V_{sw} , I_{sw})

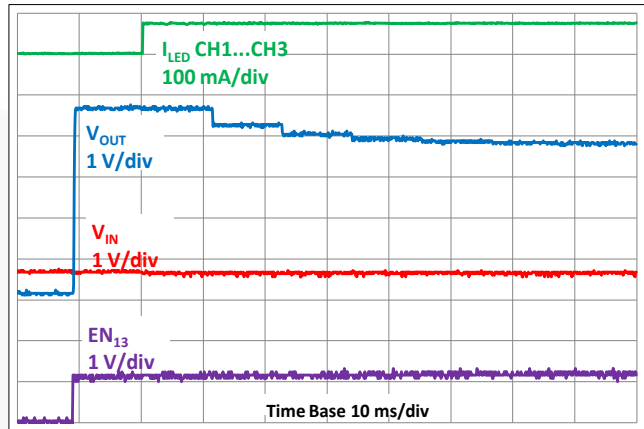

Figure 17. Startup After Enable, Three Strings Connected

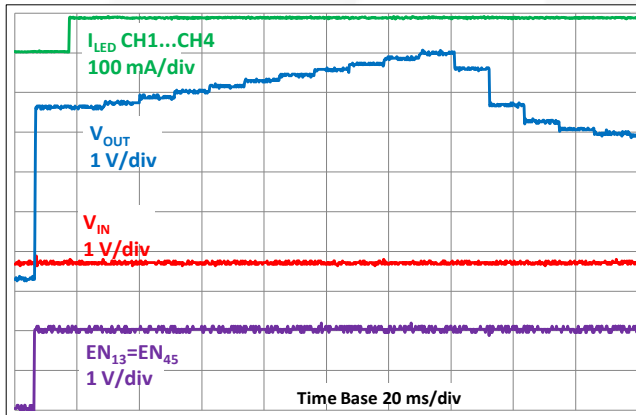

Figure 18. Startup After Enable, Four Strings Connected

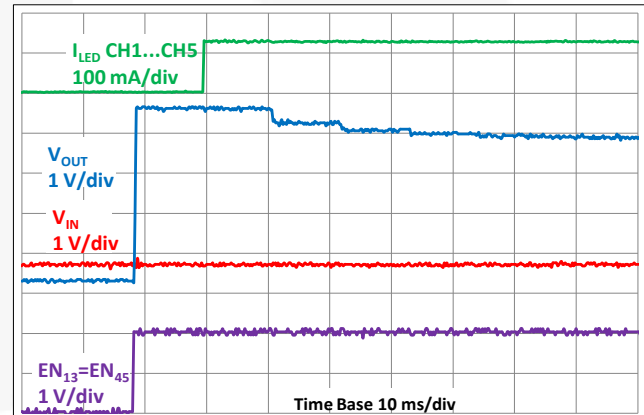

Figure 19. Startup After Enable, Five Strings Connected

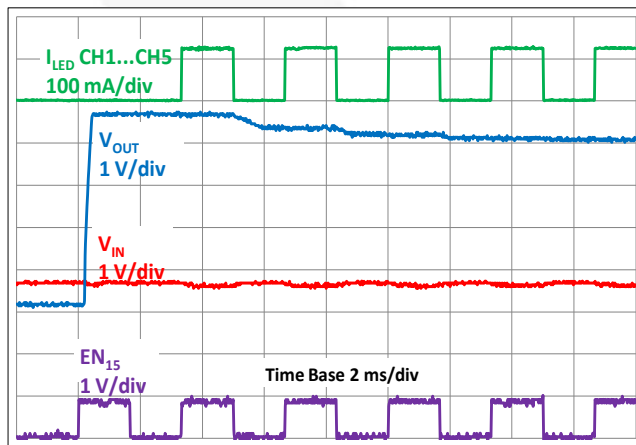

Figure 20. LED PWM Startup, Five Strings Connected

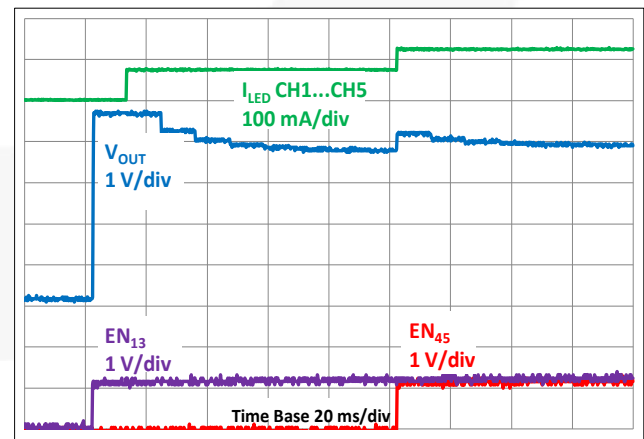

Figure 21. Startup After LED1-3 Enable Followed by LED4-5 Enable

Typical Characteristics

$V_{IN} = 3.7\text{ V}$, $T_A = 25^\circ\text{C}$, $I_{LED} = 5 \times 20\text{ mA}$, $V_{OUT} = 6.8\text{ V}$, $L1 = 4.7\text{ }\mu\text{H}$, $C_{OUT} = 10\text{ }\mu\text{F}$ (unless otherwise specified).

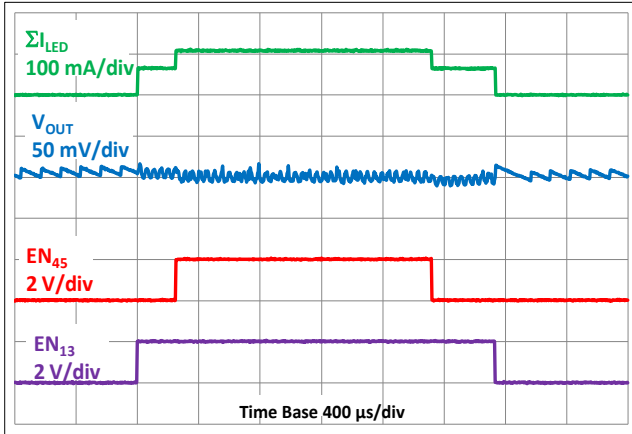

Figure 22. Asynchronous LED PWM, Two LEDs per LED String

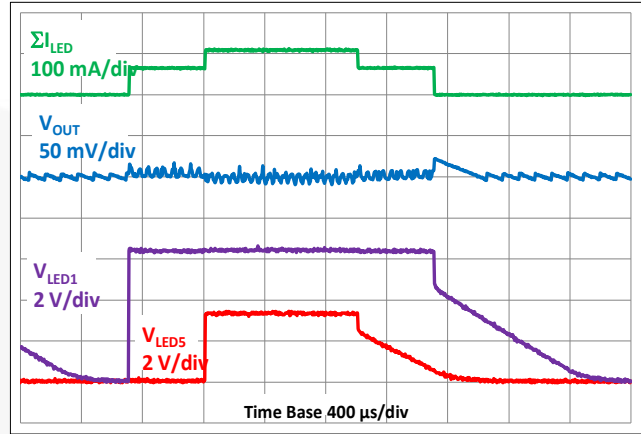

Figure 23. Asynchronous LED PWM, Two LEDs on LED1-3 Strings, Single LED on LED4-5 Strings

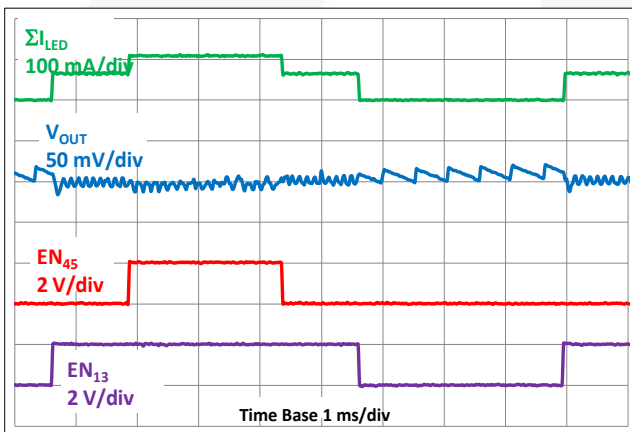

Figure 24. Asynchronous LED PWM, All LED Outputs Shorted Together for Common Load
See Figure 30

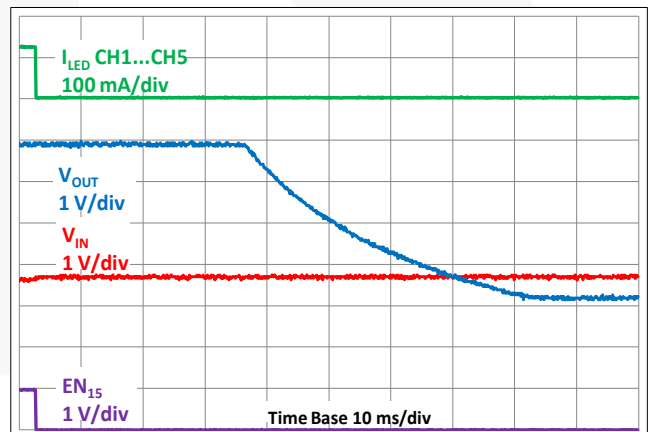

Figure 25. Device Disabled, Five Strings Connected

Circuit Description

Overview

The FAN5776 is a 1.8 MHz synchronous step-up DC-DC converter with integrated constant-current high-side LED drivers capable of driving one to five LED strings up to 5 x 25 mA LED current.

The device starts when at least one LED string is utilized and the appropriate EN pin is enabled. The device is disabled in 30 ms by setting both EN pins LOW.

The V_{OUT} voltage is internally set to 290 mV above the highest LED string voltage, and it is sampled at every falling LED PWM cycle. For 100% duty cycle, the LED-pin voltage is sampled and the V_{OUT} voltage is refined every 10 ms.

The LED strings can be disabled by connecting them to V_{OUT} or shorting them to GND. They can also be left disconnected. If the LED string is temporarily disabled or shorted, the device must be re-enabled to enable the string again.

The LED drivers work independently and allow multiple LED voltages, such that many types of LEDs can be driven at the same time and some strings can be used to drive a single LED while other channels are driving two LEDs in series. The V_{OUT} voltage is defined by the highest LED voltage and the LED driver dropout voltage is increased to provide the LED string a specific voltage. If the voltage difference between the LED strings is large, the system efficiency may decrease.

LED Current

The LED string current is set by the resistor, R_{SET} , between the ISET and GND pins. The same current is applied to across all strings such that total output current: $I_{OUT} = 5 \times I_{LED} = 5 \times 20 \text{ mA} = 100 \text{ mA}$ if $R_{SET} = 25 \text{ k}\Omega$ and all LED strings are used. In general, the LED string current can be calculated as follows:

$$I_{LED} = \frac{500}{R_{SET}} \quad (1)$$

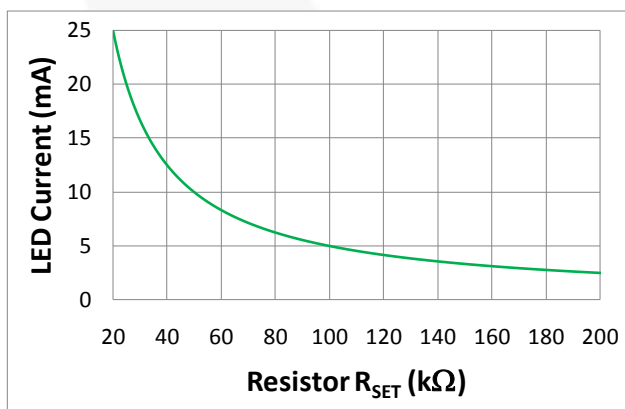

Figure 26. LED Current vs. R_{SET} Value

Startup

The three different startup functions depend on the system configuration:

1. All LED strings are utilized: Setting one or both EN pins HIGH enables the device and V_{OUT} rises to 7.5 V.

FAN5776 starts to step up or down to the appropriate regulated voltage.

2. At least one LED string in a group is shorted to GND. V_{OUT} rises to 7.5 V while the shorted LED string is disabled and the device starts to step up or down to regulated voltage.
3. At least one LED string is floating or connected to V_{OUT} . V_{OUT} rises to 9.0 V, the floating LED string is disabled, and the device starts to step down to regulated voltage.

These functions work for each group independently. If all five strings are utilized and EN13 is HIGH, V_{OUT} rises to 7.5 V (case 1) and goes to the highest voltage required by LED1-3. Then EN45 is raised and V_{OUT} is stepped up again to 7.5 V and regulates to highest voltage required by LED1-5.

If V_{OUT} cannot reach 7.5 V within 1.2 ms after an enable cycle, the device stays disabled and a new enable cycle is required.

PWM Dimming

A LED PWM signal of 100 Hz to 800 Hz can be applied to EN13 and EN45 pins to control LED1-3 and LED4-5 light intensity. The LED current is a linear function of the LED PWM duty cycle from 100% down to 0.4%. The FAN5776 can be started by a PWM signal with a low duty cycle to enable smooth startup. EN13 and EN45 pins can be operated either synchronously or asynchronously, which makes it possible to use the device to backlight two separate displays at the same time.

Under-Voltage Lockout (UVLO)

The Under-Voltage Lockout circuitry turns off all MOSFETs and the device remains in a very low quiescent current state until V_{IN} has risen above the UVLO threshold.

Short-Circuit Protection (SCP)

The LED driver output current is limited to 0.5 μA or less when a LED number pin voltage is below 1.0 V. This limit shall be applied within one LED PWM cycle, or 10 ms, whichever elapses first.

Over-Voltage Protection (OVP)

When the regulator is active, it monitors the V_{OUT} pin. If the V_{OUT} voltage reaches 9.0 V, the regulator stops switching until the capacitor at V_{OUT} discharges below 8.5 V.

LED-Open Detection

If V_{OUT} is detected above >9.0 V, the LED voltages are scanned. All LED pins with voltage greater than $V_{OUT} - 0.5 \text{ V}$ are disabled. If all LED pins' voltages exceed 8.5 V and V_{OUT} is greater than 9.0 V, device is disabled and a new startup cycle is required.

Over-Current Protection (OCP)

The PWM converter is protected against overload through cycle-by cycle current limit using a fixed internal limit.

Thermal Shutdown

When the die temperature exceeds 150°C, reset occurs and remains in effect until the die cools to 125°C; at which time, the circuit enters the normal soft-start sequence.

Applications

External Component Selection

Four external components are required to power the FAN5776: an inductor between the VIN and SW pins, storage capacitor at the output, storage capacitor at the input, and reference resistor at the ISET pin.

The inductor's minimum inductance requirement is $2.45 \mu\text{H}$ with an $\text{ESR} \leq 300 \text{ m}\Omega$ at 500 mA bias current at 1.8 MHz frequency. A lower inductance drops device efficiency, while a higher inductance reduces output ripple.

The minimum capacitance for the output capacitor is $4.8 \mu\text{F}$ at 5 V. Note that the ceramic capacitor value depends on the DC bias voltage. Check the datasheet of the capacitor to make sure the capacitor meets all specifications.

An input capacitor of $2.2 \mu\text{F}$ is recommended to improve device's transient behavior. Ensure the V_{IN} supply voltage is ripple-free for optimal device performance.

The reference resistor value is at least $20 \text{ k}\Omega$. The LED current accuracy is defined by this resistor and a high-precision resistor with low temperature dependency is recommended. To guarantee the FAN5776 performance and achieve I_{LED} maximum current of 25 mA, $20 \text{ k}\Omega$, $\pm 1\%$ or better resistor must be used.

PCB Layout Guidelines

A separate ground plane is recommended to minimize noise. Place the FAN5776 device, inductor (L), C_{IN} and C_{OUT} capacitors, and their interconnections on the same side of the board. High-current paths from the supply voltage to the SW pin via the inductor, and GND pin to ground plane, are recommended as low resistance paths. Keep the VOUT-pin-to- C_{OUT} -capacitor path as short as possible to minimize the inductance of the VOUT-pin-to- C_{OUT} for low V_{OUT} ripple voltage. Minimize the SW pin capacitance to realize optimum system efficiency. Keep the ISET-pin-to- R_{SET} -resistor path away from noisy signals (SW pin) to minimize crosstalk from the SW pin to the ISET pin.

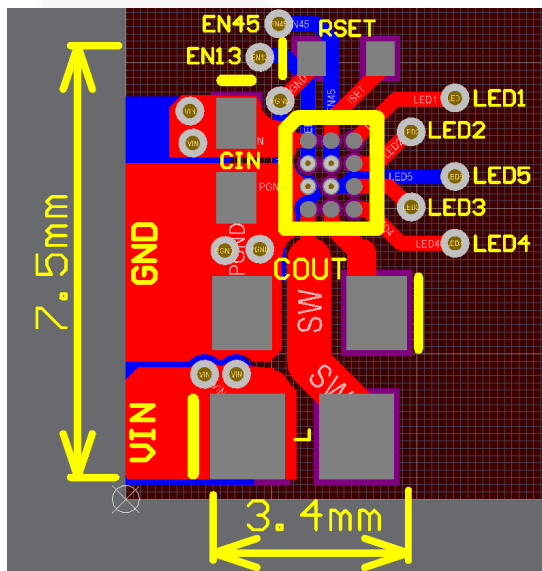

Figure 27. Recommended PCB Layout

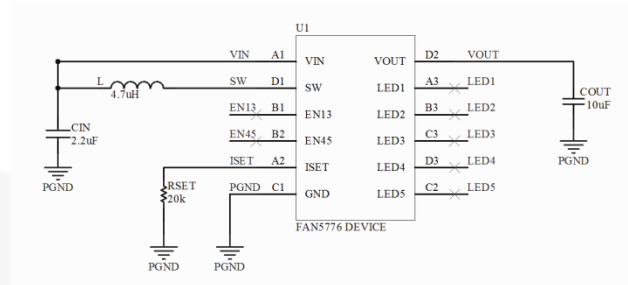

Figure 28. Schematic for Recommended Layout

Startup Power Minimization

The FAN5776 is optimized to minimize startup power when all five LED driver outputs are connected to LEDs. Where some of the LED strings are not used due to smaller LCD display size, the startup power can still be minimized. Connecting the unused LED driver outputs to ground (GND) prevents LED current drop during startup and V_{OUT} starts at 7.5 V, which reduces power consumption. Secondly, the unused LED driver outputs connected to GND are disabled at startup, minimizing the leakage current to GND. If left open the unused LED strings cause V_{OUT} to rise to the OVP voltage of 9.0 V instead of starting at 7.5 V. The device detects an open circuit due to the unused LED strings and therefore goes up to 9.0 V, then adjusts to a V_{OUT} that is appropriate to power the LED strings.

The device is also working to specification when un-used LED drivers are connected to the VOUT pin or left floating.

Combined LCD Backlight and Blinker

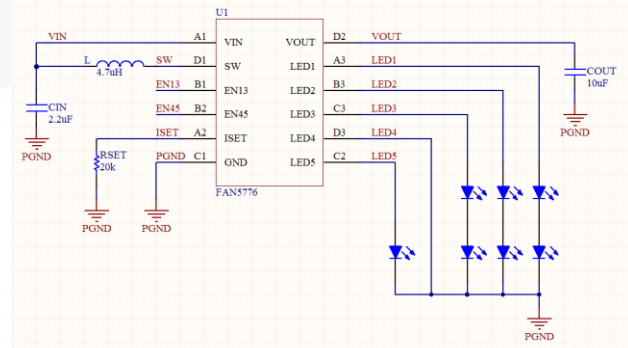

Figure 29. Schematic for Screen Backlight and Blinker

The FAN5776 can be utilized for different lighting applications by configuring it to suit the design requirements. Each LED driver output is independent such that each output can support a different output voltage while being controlled simultaneously.

Configuring the FAN5776 with a different number of LEDs for each output results in a lower system efficiency because the outputs with a single LED have a higher dropout voltage compared to the outputs with two LEDs in series. The system efficiency (η) is calculated as follows:

$$\eta = \sum_{i=1}^5 \frac{I_i V_i}{I_{IN} V_{IN}} \quad (2)$$

where:

- I_i is the LED(i) channel current;
- V_i is the LED(i) channel voltage;
- I_{IN} is the supply current (rms); and
- V_{IN} is the supply voltage (rms).

If all the LED strings are equivalent, $I_1 = I_2 = \dots = I_5$ and $V_1 = V_2 = \dots = V_5$ and N channels are used ($N = 1, 2, 3, 4$ or 5), the equation simplifies to:

$$\eta = N \frac{I_{LED} V_{LED}}{I_{IN} V_{IN}} \quad (3)$$

where:

- I_{LED} is the LED channel current (total output current is $N \cdot I_{LED}$) and V_{LED} is the LED channel voltage.

There are two LED output groups with separate control for each group. EN13 and EN45 pins are the control/PWM for LED1-3 and LED4-5 outputs, respectively.

Figure 29 illustrates an application where the FAN5776 uses three LED outputs (LED1 to LED3) with two LEDs in series per channel to backlight the main LCD display, while LED5 powers a single LED for blinking functionality. LED4 is unused and connected to GND. Backlighting and PWM dimming of the LEDs for the LCD display are controlled by EN13, while EN45 controls the blinking and dimming level for LED5.

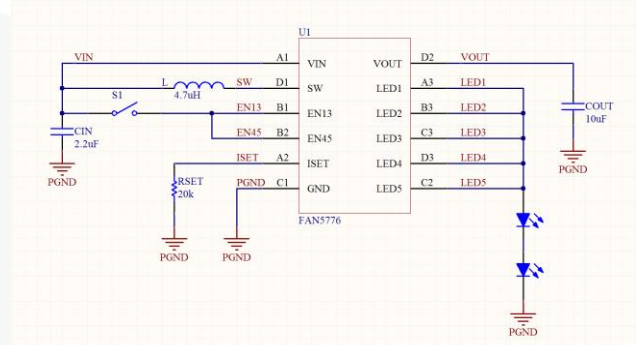
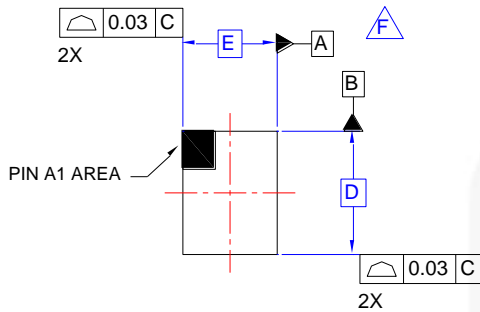

Figure 30. Schematic for Flashlight Applications

To use FAN5776 as an LED flashlight driver, as shown in Figure 30, connect VIN to the battery voltage and add a single-pole switch (mechanical or electrical) from EN13 and/or EN45 pins to VIN. Pull-down resistors on the EN pins disable the device when the switch is in a non-conducting state.

Physical Dimensions



TOP VIEW

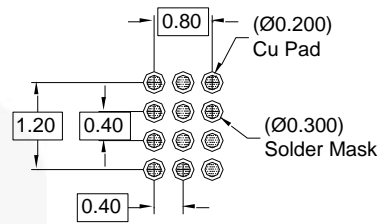

RECOMMENDED LAND PATTERN
(NSMD PAD TYPE)

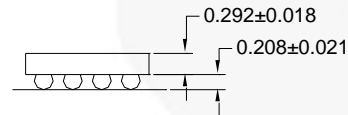
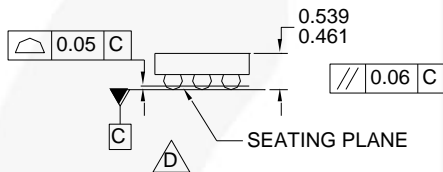

SIDE VIEWS

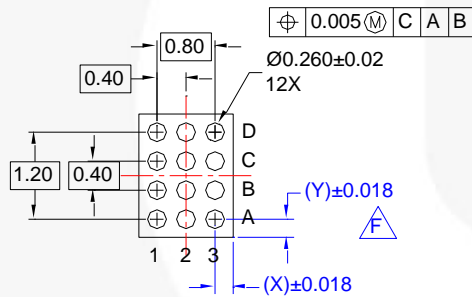

BOTTOM VIEW

NOTES:

- A. NO JEDEC REGISTRATION APPLIES.
- B. DIMENSIONS ARE IN MILLIMETERS.
- C. DIMENSIONS AND TOLERANCES PER ASME Y14.5M, 1994.
- D. DATUM C IS DEFINED BY THE SPHERICAL CROWNS OF THE BALLS.
- E. PACKAGE NOMINAL HEIGHT IS 500 MICRONS ±39 MICRONS (461-539 MICRONS).
- F. FOR DIMENSIONS D, E, X, AND Y SEE PRODUCT DATASHEET.
- G. DRAWING FILENAME: MKT-UC012ADrev1.

Figure 31. 12-Bump, Wafer-Level Chip-Scale Package (WLCSP) 1.42 x 1.66 x 0.50 mm, 0.40 mm Pitch

Product-Specific Dimensions

D	E	X	Y
1.660 mm	1.420 mm	0.310 mm	0.230 mm





Package drawings are provided as a service to customers considering Fairchild components. Drawings may change in any manner without notice. Please note the revision and/or date on the drawing and contact a Fairchild Semiconductor representative to verify or obtain the most recent revision. Package specifications do not expand the terms of Fairchild's worldwide terms and conditions, specifically the warranty therein, which covers Fairchild products.

Always visit Fairchild Semiconductor's online packaging area for the most recent package drawings:
<http://www.fairchildsemi.com/dwg/UC/UC012AD.pdf>



TRADEMARKS

The following includes registered and unregistered trademarks and service marks, owned by Fairchild Semiconductor and/or its global subsidiaries, and is not intended to be an exhaustive list of all such trademarks.

- | | | | |
|---|--|---|---|
| AccuPower™ | F-PFS™ |  | Sync-Lock™ |
| AX-CAP®* | FRFET® | PowerTrench® |  |
| BitSiC™ | Global Power Resource™ | PowerXS™ | TinyBoost® |
| Build it Now™ | GreenBridge™ | Programmable Active Droop™ | TinyBuck® |
| CorePLUS™ | Green FPS™ | QFET® | TinyCalc™ |
| CorePOWER™ | Green FPS™ e-Series™ | QS™ | TinyLogic® |
| CROSSVOLT™ | Gmax™ | Quiet Series™ | TINYOPTO™ |
| CTL™ | GTO™ | RapidConfigure™ | TinyPower™ |
| Current Transfer Logic™ | IntelliMAX™ |  | TinyPWM™ |
| DEUXPEED® | ISOPLANAR™ | Saving our world, 1mW/W/kW at a time™ | TinyWire™ |
| Dual Cool™ | Making Small Speakers Sound Louder and Better™ | SignalWise™ | TransiC™ |
| EcoSPARK® | MegaBuck™ | SmartMax™ | TriFault Detect™ |
| EfficientMax™ | MICROCOUPLER™ | SMART START™ | TRUECURRENT®* |
| ESBC™ | MicroFET™ | Solutions for Your Success™ | µSerDes™ |
|  | MicroPak™ | SPM® |  |
| Fairchild® | MicroPak2™ | STEALTH™ | UHC® |
| Fairchild Semiconductor® | MillerDrive™ | SuperFET® | Ultra FRFET™ |
| FACT Quiet Series™ | MotionMax™ | SuperSOT™-3 | UniFET™ |
| FACT® | mWSaver® | SuperSOT™-6 | VCX™ |
| FAST® | OptoHit™ | SuperSOT™-8 | VisualMax™ |
| FastvCore™ | OPTOLOGIC® | SupreMOS® | VoltagePlus™ |
| FETBench™ | OPTOPLANAR® | SyncFET™ | XS™ |
| FPS™ | | | |

* Trademarks of System General Corporation, used under license by Fairchild Semiconductor.

DISCLAIMER

FAIRCHILD SEMICONDUCTOR RESERVES THE RIGHT TO MAKE CHANGES WITHOUT FURTHER NOTICE TO ANY PRODUCTS HEREIN TO IMPROVE RELIABILITY, FUNCTION, OR DESIGN. FAIRCHILD DOES NOT ASSUME ANY LIABILITY ARISING OUT OF THE APPLICATION OR USE OF ANY PRODUCT OR CIRCUIT DESCRIBED HEREIN; NEITHER DOES IT CONVEY ANY LICENSE UNDER ITS PATENT RIGHTS, NOR THE RIGHTS OF OTHERS. THESE SPECIFICATIONS DO NOT EXPAND THE TERMS OF FAIRCHILD'S WORLDWIDE TERMS AND CONDITIONS, SPECIFICALLY THE WARRANTY THEREIN, WHICH COVERS THESE PRODUCTS.

LIFE SUPPORT POLICY

FAIRCHILD'S PRODUCTS ARE NOT AUTHORIZED FOR USE AS CRITICAL COMPONENTS IN LIFE SUPPORT DEVICES OR SYSTEMS WITHOUT THE EXPRESS WRITTEN APPROVAL OF FAIRCHILD SEMICONDUCTOR CORPORATION.

As used herein:

- Life support devices or systems are devices or systems which, (a) are intended for surgical implant into the body or (b) support or sustain life, and (c) whose failure to perform when properly used in accordance with instructions for use provided in the labeling, can be reasonably expected to result in a significant injury of the user.
- A critical component in any component of a life support, device, or system whose failure to perform can be reasonably expected to cause the failure of the life support device or system, or to affect its safety or effectiveness.

ANTI-COUNTERFEITING POLICY

Fairchild Semiconductor Corporation's Anti-Counterfeiting Policy. Fairchild's Anti-Counterfeiting Policy is also stated on our external website, www.fairchildsemi.com, under Sales Support.

Counterfeiting of semiconductor parts is a growing problem in the industry. All manufacturers of semiconductor products are experiencing counterfeiting of their parts. Customers who inadvertently purchase counterfeit parts experience many problems such as loss of brand reputation, substandard performance, failed applications, and increased cost of production and manufacturing delays. Fairchild is taking strong measures to protect ourselves and our customers from the proliferation of counterfeit parts. Fairchild strongly encourages customers to purchase Fairchild parts either directly from Fairchild or from Authorized Fairchild Distributors who are listed by country on our web page cited above. Products customers buy either from Fairchild directly or from Authorized Fairchild Distributors are genuine parts, have full traceability, meet Fairchild's quality standards for handling and storage and provide access to Fairchild's full range of up-to-date technical and product information. Fairchild and our Authorized Distributors will stand behind all warranties and will appropriately address any warranty issues that may arise. Fairchild will not provide any warranty coverage or other assistance for parts bought from Unauthorized Sources. Fairchild is committed to combat this global problem and encourage our customers to do their part in stopping this practice by buying direct or from authorized distributors.

PRODUCT STATUS DEFINITIONS

Definition of Terms

Datasheet Identification	Product Status	Definition
Advance Information	Formative / In Design	Datasheet contains the design specifications for product development. Specifications may change in any manner without notice.
Preliminary	First Production	Datasheet contains preliminary data; supplementary data will be published at a later date. Fairchild Semiconductor reserves the right to make changes at any time without notice to improve design.
No Identification Needed	Full Production	Datasheet contains final specifications. Fairchild Semiconductor reserves the right to make changes at any time without notice to improve the design.
Obsolete	Not In Production	Datasheet contains specifications on a product that is discontinued by Fairchild Semiconductor. The datasheet is for reference information only.

Rev. I66

Mouser Electronics

Authorized Distributor

Click to View Pricing, Inventory, Delivery & Lifecycle Information:

[Fairchild Semiconductor:](#)

[FAN5776UCX](#)