



Is Now Part of



**ON Semiconductor®**

To learn more about ON Semiconductor, please visit our website at  
[www.onsemi.com](http://www.onsemi.com)

ON Semiconductor and the ON Semiconductor logo are trademarks of Semiconductor Components Industries, LLC dba ON Semiconductor or its subsidiaries in the United States and/or other countries. ON Semiconductor owns the rights to a number of patents, trademarks, copyrights, trade secrets, and other intellectual property. A listing of ON Semiconductor's product/patent coverage may be accessed at [www.onsemi.com/site/pdf/Patent-Marking.pdf](http://www.onsemi.com/site/pdf/Patent-Marking.pdf). ON Semiconductor reserves the right to make changes without further notice to any products herein. ON Semiconductor makes no warranty, representation or guarantee regarding the suitability of its products for any particular purpose, nor does ON Semiconductor assume any liability arising out of the application or use of any product or circuit, and specifically disclaims any and all liability, including without limitation special, consequential or incidental damages. Buyer is responsible for its products and applications using ON Semiconductor products, including compliance with all laws, regulations and safety requirements or standards, regardless of any support or applications information provided by ON Semiconductor. "Typical" parameters which may be provided in ON Semiconductor data sheets and/or specifications can and do vary in different applications and actual performance may vary over time. All operating parameters, including "Typicals" must be validated for each customer application by customer's technical experts. ON Semiconductor does not convey any license under its patent rights nor the rights of others. ON Semiconductor products are not designed, intended, or authorized for use as a critical component in life support systems or any FDA Class 3 medical devices or medical devices with a same or similar classification in a foreign jurisdiction or any devices intended for implantation in the human body. Should Buyer purchase or use ON Semiconductor products for any such unintended or unauthorized application, Buyer shall indemnify and hold ON Semiconductor and its officers, employees, subsidiaries, affiliates, and distributors harmless against all claims, costs, damages, and expenses, and reasonable attorney fees arising out of, directly or indirectly, any claim of personal injury or death associated with such unintended or unauthorized use, even if such claim alleges that ON Semiconductor was negligent regarding the design or manufacture of the part. ON Semiconductor is an Equal Opportunity/Affirmative Action Employer. This literature is subject to all applicable copyright laws and is not for resale in any manner.



# FPF1005-FPF1006 IntelliMAX™ Advanced Load Management Products

## Features

- 1.2 to 5.5V Input Voltage Range
- Typical  $R_{DS(ON)} = 50m\Omega @ V_{IN} = 5.5V$
- Typical  $R_{DS(ON)} = 55m\Omega @ V_{IN} = 3.3V$
- ESD Protected, above 2000V HBM

## Applications

- PDAs
- Cell Phones
- GPS Devices
- MP3 Players
- Digital Cameras
- Peripheral Ports
- Hot Swap Supplies
- RoHS Compliant

## General Description

The FPF1005 & FPF1006 are low  $R_{DS}$  P-Channel MOSFET load switches with CMOS controlled turn-on targeting small package load switch applications. The input voltage range operates from 1.2V to 5.5V. Switch control is by a logic input (ON) capable of interfacing directly with low voltage control signals. In FPF1006, 120 $\Omega$  on-chip load resistor is added for output quick discharge when switch is turned off.

Both FPF1005 & FPF1006 are available in a small 2X2 MicroFET-6 pin plastic package.

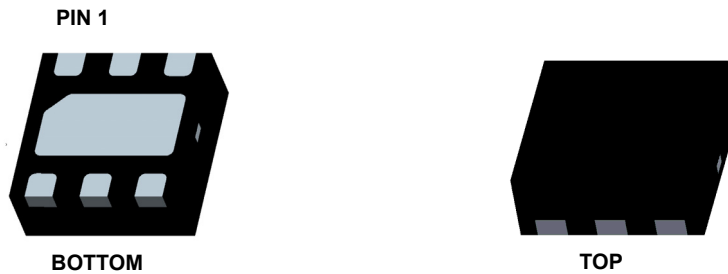

## Typical Application Circuit

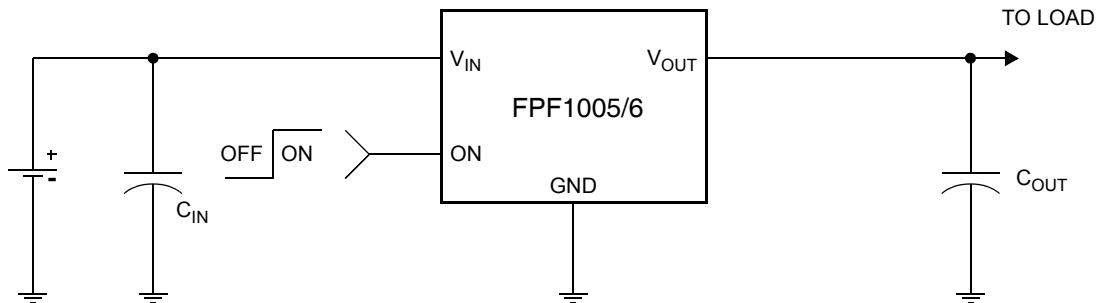

## Ordering Information

Part	Switch	Input Buffer	Output Discharge	ON Pin Activity
FPF1005	55m $\Omega$ , PMOS	Schmitt	NA	Active HI
FPF1006	55m $\Omega$ , PMOS	Schmitt	120 $\Omega$	Active HI

## Functional Block Diagram

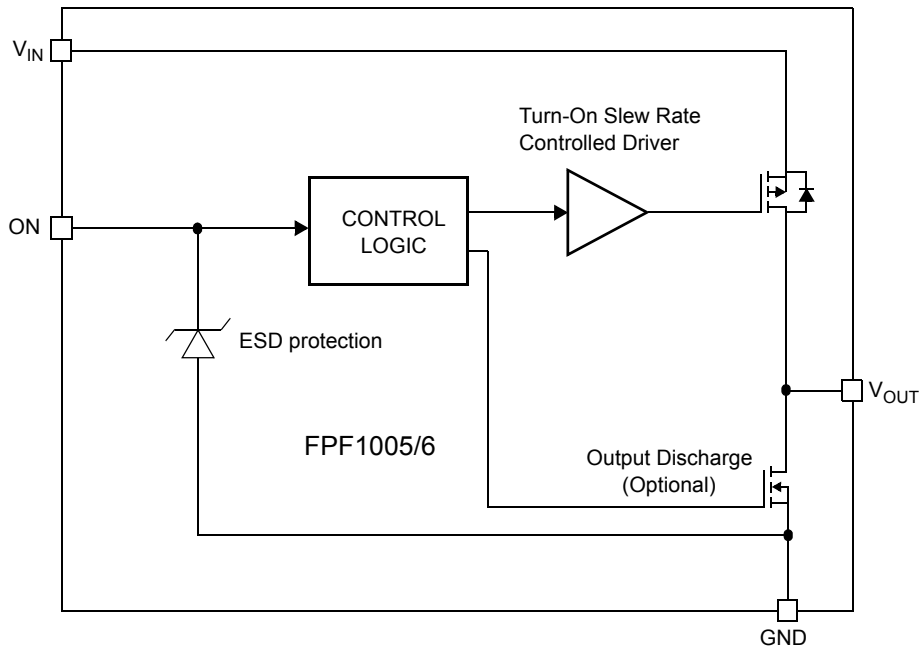

## Pin Configuration

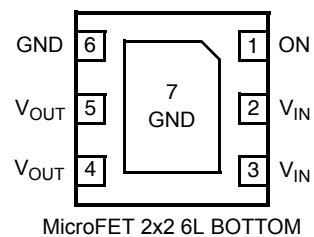

## Pin Description

Pin	Name	Function
4, 5	$V_{OUT}$	Switch Output: Output of the power switch
2, 3	$V_{IN}$	Supply Input: Input to the power switch and the supply voltage for the IC
6, 7	GND	Ground
1	ON	ON/OFF Control Input

## Absolute Maximum Ratings

Parameter	Min	Max	Unit
$V_{IN}$ , $V_{OUT}$ , ON to GND	-0.3	6	V
Maximum Continuous Switch Current		1.5	A
Power Dissipation @ $T_A = 25^\circ\text{C}$ (Note 1)		1.2	W
Operating Temperature Range	-40	85	$^\circ\text{C}$
Storage Temperature	-65	150	$^\circ\text{C}$
Thermal Resistance, Junction to Ambient		86	$^\circ\text{C/W}$
Electrostatic Discharge Protection	HBM	2000	V
	MM	200	V

## Recommended Operating Range

Parameter	Min	Max	Unit
$V_{IN}$	1.2	5.5	V
Ambient Operating Temperature, $T_A$	-40	85	$^\circ\text{C}$

## Electrical Characteristics

$V_{IN} = 1.2$  to  $5.5\text{V}$ ,  $T_A = -40$  to  $+85^\circ\text{C}$  unless otherwise noted. Typical values are at  $V_{IN} = 3.3\text{V}$  and  $T_A = 25^\circ\text{C}$ .

Parameter	Symbol	Conditions	Min	Typ	Max	Unit
<b>Basic Operation</b>						
Operating Voltage	$V_{IN}$		1.2		5.5	V
Quiescent Current	$I_Q$	$I_{OUT} = 0\text{mA}$ , $V_{IN} = V_{ON}$			1	$\mu\text{A}$
Off Supply Current	$I_{Q(off)}$	$V_{ON} = \text{GND}$ , $\text{OUT} = \text{open}$			1	$\mu\text{A}$
Off Switch Current	$I_{SD(off)}$	$V_{ON} = \text{GND}$ , $V_{OUT} = 0\text{V}$ @ $V_{IN} = 5.5\text{V}$ , $T_A = 85^\circ\text{C}$			1	$\mu\text{A}$
		$V_{ON} = \text{GND}$ , $V_{OUT} = 0\text{V}$ @ $V_{IN} = 3.3\text{V}$ , $T_A = 25^\circ\text{C}$		10	100	nA
On-Resistance	$R_{ON}$	$V_{IN} = 5.5\text{V}$ , $T_A = 25^\circ\text{C}$		50	70	m $\Omega$
		$V_{IN} = 3.3\text{V}$ , $T_A = 25^\circ\text{C}$		55	80	
		$V_{IN} = 1.5\text{V}$ , $T_A = 25^\circ\text{C}$		95	135	
		$V_{IN} = 1.2\text{V}$ , $T_A = 25^\circ\text{C}$		165	250	
Output Pull Down Resistance	$R_{PD}$	$V_{IN} = 3.3\text{V}$ , $V_{ON} = 0\text{V}$ , $T_A = 25^\circ\text{C}$ , FPF1006		75	120	$\Omega$
ON Input Logic Low Voltage	$V_{IL}$	$V_{IN} = 5.5\text{V}$			1.25	V
		$V_{IN} = 4.5\text{V}$			1.10	
		$V_{IN} = 1.5\text{V}$			0.50	
ON Input Logic High Voltage	$V_{IH}$	$V_{IN} = 5.5\text{V}$	2.00			V
		$V_{IN} = 4.5\text{V}$	1.75			
		$V_{IN} = 1.5\text{V}$	0.75			
ON Input Leakage		$V_{ON} = V_{IN}$ or GND	-1		1	$\mu\text{A}$
<b>Dynamic</b>						
Turn on delay	$t_{ON}$	$V_{IN} = 3.3\text{V}$ , $R_L = 500\Omega$ , $C_L = 0.1\mu\text{F}$ , $T_A = 25^\circ\text{C}$		10		$\mu\text{s}$
Turn off delay	$t_{OFF}$	$V_{IN} = 3.3\text{V}$ , $R_L = 500\Omega$ , $C_L = 0.1\mu\text{F}$ , $T_A = 25^\circ\text{C}$ , FPF1005		50		$\mu\text{s}$
		$V_{IN} = 3.3\text{V}$ , $R_L = 500\Omega$ , $C_L = 0.1\mu\text{F}$ , $R_{L\_CHIP} = 120\Omega$ , $T_A = 25^\circ\text{C}$ , FPF1006		10		$\mu\text{s}$
$V_{OUT}$ Rise Time	$t_R$	$V_{IN} = 3.3\text{V}$ , $R_L = 500\Omega$ , $C_L = 0.1\mu\text{F}$ , $T_A = 25^\circ\text{C}$		10		$\mu\text{s}$
$V_{OUT}$ Fall Time	$t_F$	$V_{IN} = 3.3\text{V}$ , $R_L = 500\Omega$ , $C_L = 0.1\mu\text{F}$ , $T_A = 25^\circ\text{C}$ , FPF1005		100		$\mu\text{s}$
		$V_{IN} = 3.3\text{V}$ , $R_L = 500\Omega$ , $C_L = 0.1\mu\text{F}$ , $R_{L\_CHIP} = 120\Omega$ , $T_A = 25^\circ\text{C}$ , FPF1006		10		$\mu\text{s}$

**Note 1:** Package power dissipation on 1square inch pad, 2 oz. copper board

### Typical Characteristics

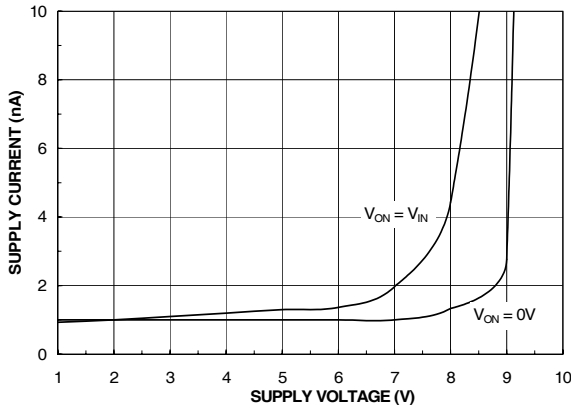

Figure 1. Quiescent Current vs.  $V_{IN}$

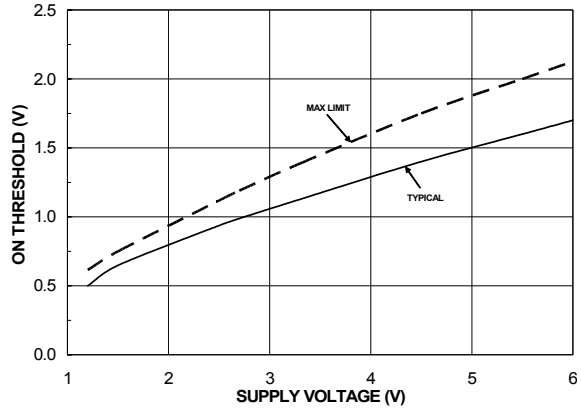

Figure 2. ON Threshold vs.  $V_{IN}$

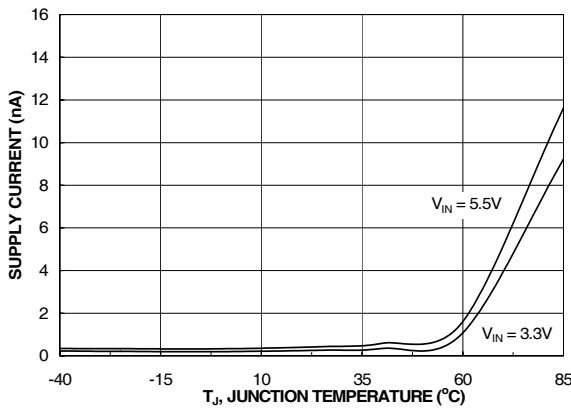

Figure 3. Quiescent Current vs. Temperature

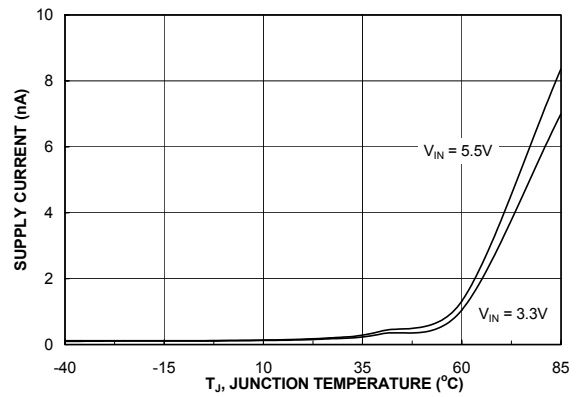

Figure 4. Quiescent Current (off) vs. Temperature

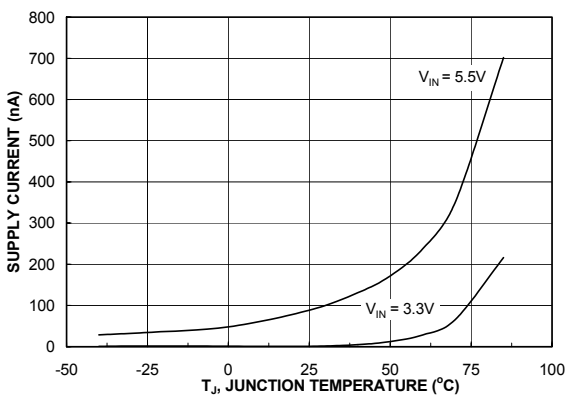

Figure 5.  $I_{\text{SWITCH-OFF}}$  Current vs. Temperature

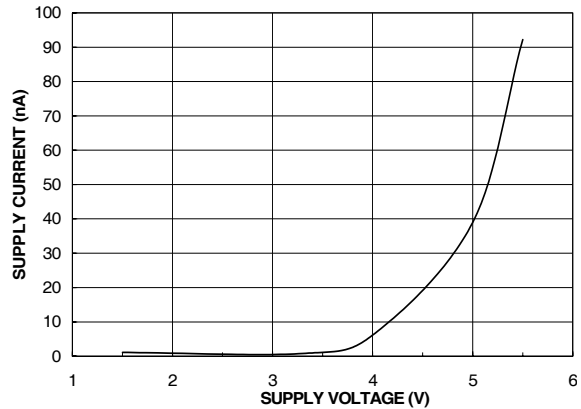

Figure 6.  $I_{\text{SWITCH-OFF}}$  Current vs.  $V_{IN}$

### Typical Characteristics

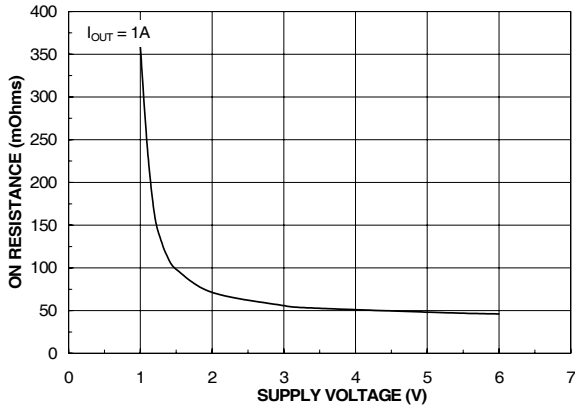

Figure 7.  $R_{ON}$  vs.  $V_{IN}$

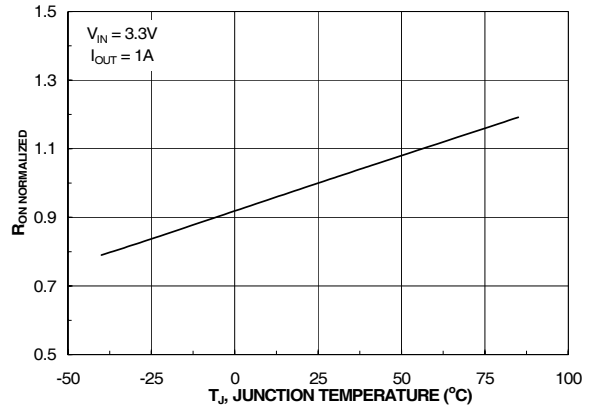

Figure 8.  $R_{ON}$  vs. Temperature

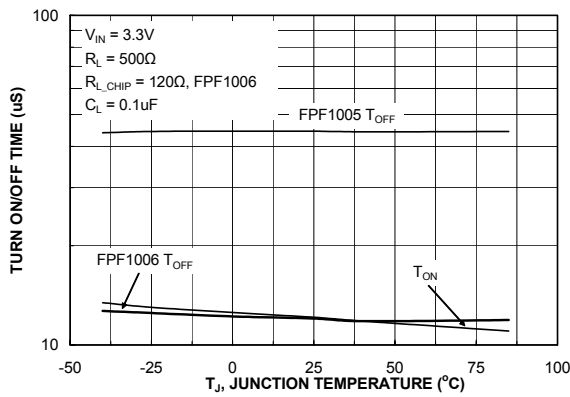

Figure 9.  $T_{ON}/T_{OFF}$  vs. Temperature

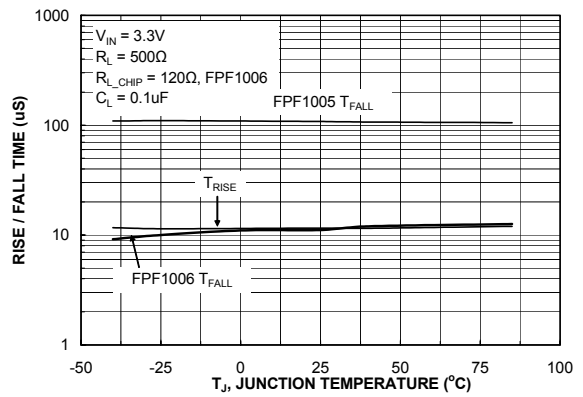

Figure 10.  $T_{RISE}/T_{FALL}$  vs. Temperature

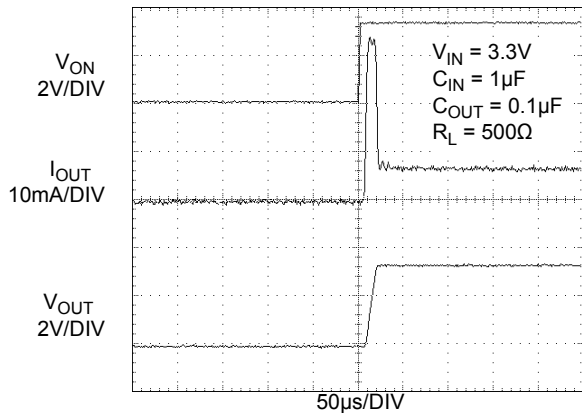

Figure 11. FPF1005  $T_{ON}$  Response

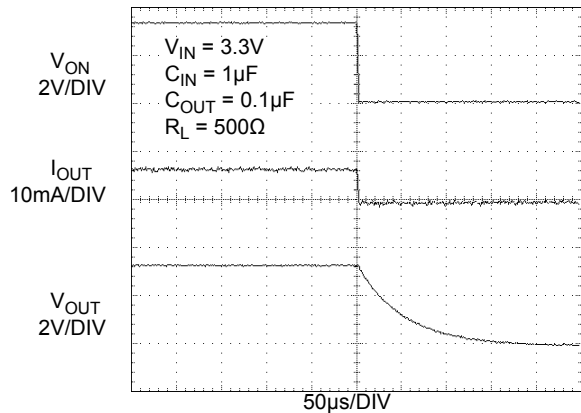

Figure 12. FPF1005  $T_{OFF}$  Response

## Typical Characteristics

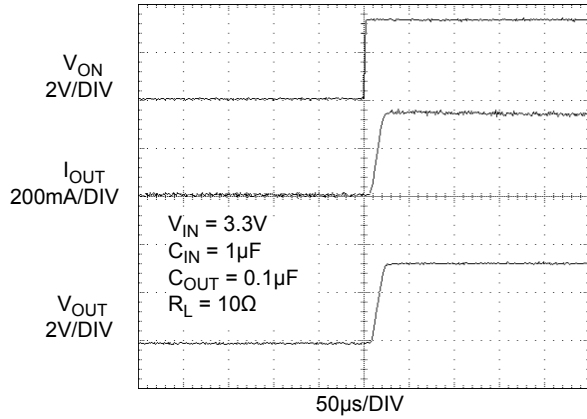

Figure 13. FPF1005  $T_{ON}$  Response

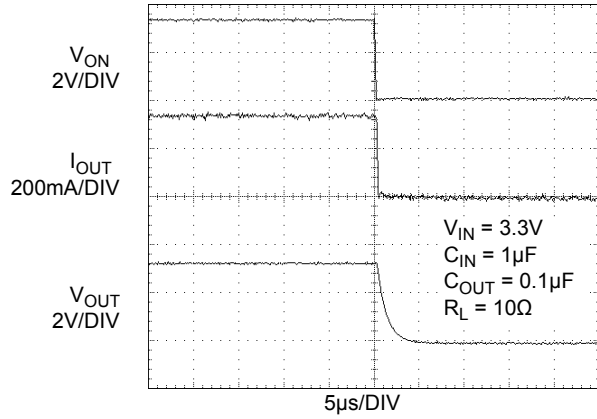

Figure 14. FPF1005  $T_{OFF}$  Response

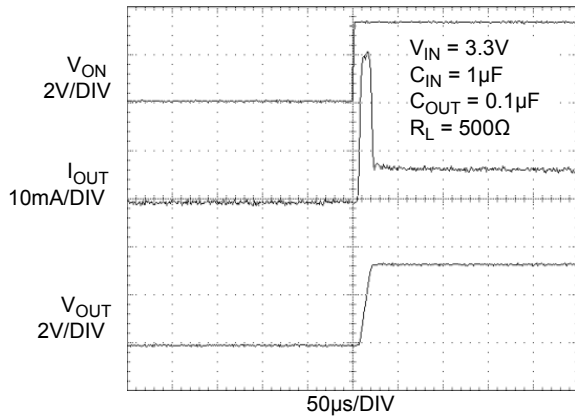

Figure 15. FPF1006  $T_{ON}$  Response

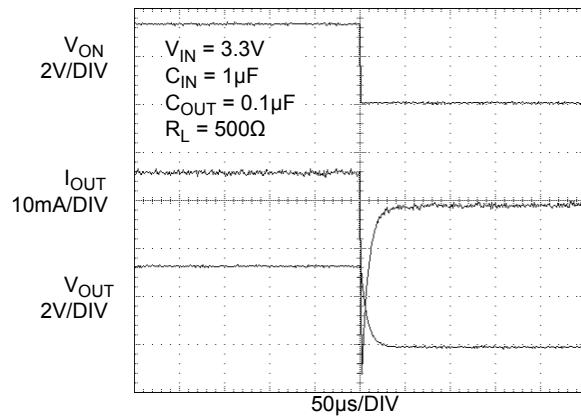

Figure 16. FPF1006  $T_{OFF}$  Response

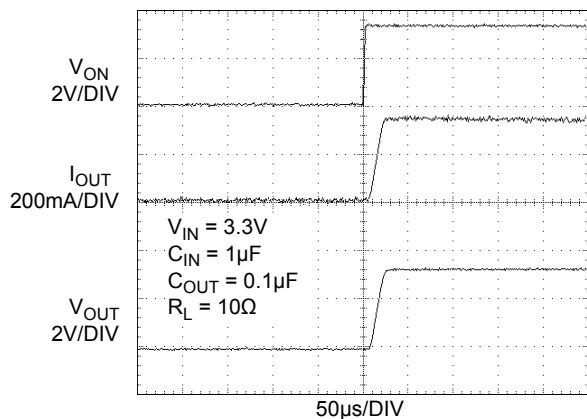

Figure 17. FPF1006  $T_{ON}$  Response

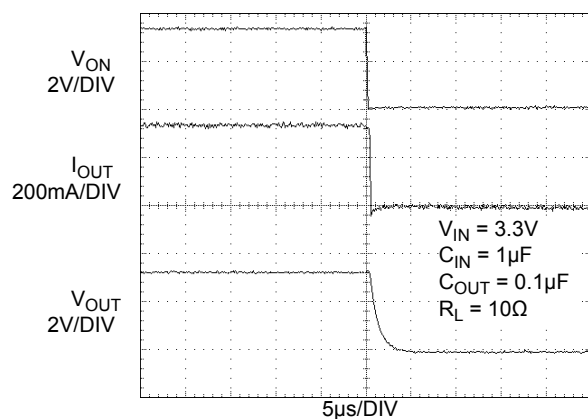

Figure 18. FPF1006  $T_{OFF}$  Response

## Description of Operation

The FPF1005 & FPF1006 are low  $R_{DS(ON)}$  P-Channel load switches with controlled turn-on. The core of each device is a 55mΩ P-Channel MOSFET and a controller capable of functioning over a wide input operating range of 1.2-5.5V. The ON pin, an active HI TTL compatible input, controls the state of the switch. The FPF1006 contains a 120Ω on-chip load resistor for quick output discharge when the switch is turned off.

However,  $V_{OUT}$  pin of FPF1006 should not be connected directly to the battery source due to the discharge mechanism of the load switch.

## Application Information

### Typical Application

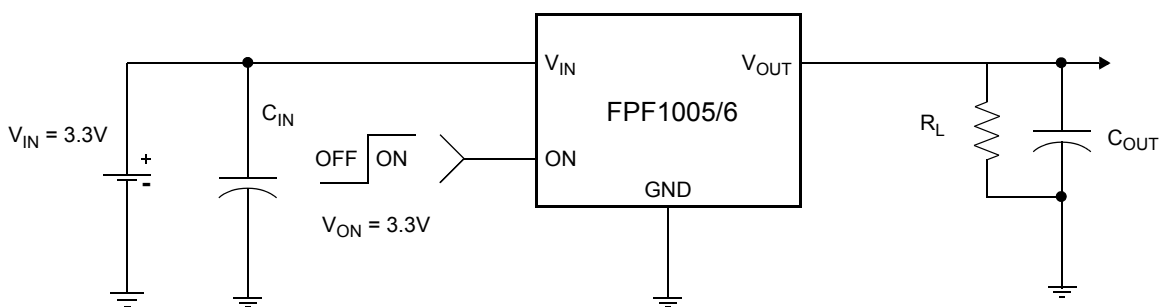

### Input Capacitor

To limit the voltage drop on the input supply caused by transient in-rush currents when the switch turns-on into a discharged load capacitor or short-circuit, a capacitor needs to be placed between  $V_{IN}$  and GND. A 1μF ceramic capacitor,  $C_{IN}$ , placed close to the pins is usually sufficient. Higher values of  $C_{IN}$  can be used to further reduce the voltage drop during higher current application.

### Output Capacitor

A 0.1μF capacitor,  $C_{OUT}$ , should be placed between  $V_{OUT}$  and GND. This capacitor will prevent parasitic board inductance from forcing  $V_{OUT}$  below GND when the switch turns-off. Due to the integral body diode in the PMOS switch, a  $C_{IN}$  greater than  $C_{OUT}$  is highly recommended. A  $C_{OUT}$  greater than  $C_{IN}$  can cause  $V_{OUT}$  to exceed  $V_{IN}$  when the system supply is removed. This could result in current flow through the body diode from  $V_{OUT}$  to  $V_{IN}$ .

### Board Layout

For best performance, all traces should be as short as possible. To be most effective, the input and output capacitors should be placed close to the device to minimize the effects that parasitic trace inductances may have on normal and short-circuit operation. Using wide traces or large copper planes for all pins ( $V_{IN}$ ,  $V_{OUT}$ , ON and GND) will help minimize the parasitic electrical effects along with minimizing the case to ambient thermal impedance.



## Evaluation Board Layout

FPF1005/6 Demo board has the components and circuitry to demonstrate the load switch functions. Thermal performance of the load switch can be improved significantly by connecting the middle pad (pin 7) to the GND area of the PCB.

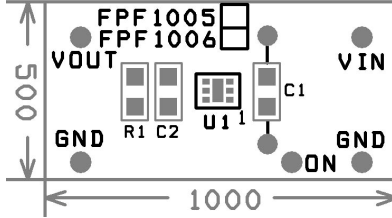

Figure 19. Demo board silk screen top and component assembly drawing.

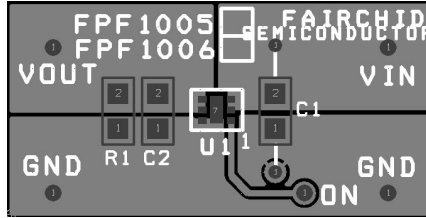

Figure 20. Demo board top and surface mount top layers view. (Pin 7 is connected to GND).

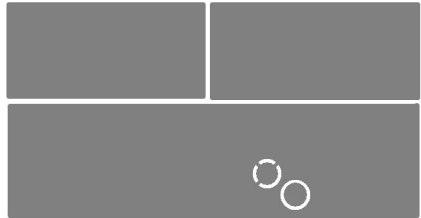
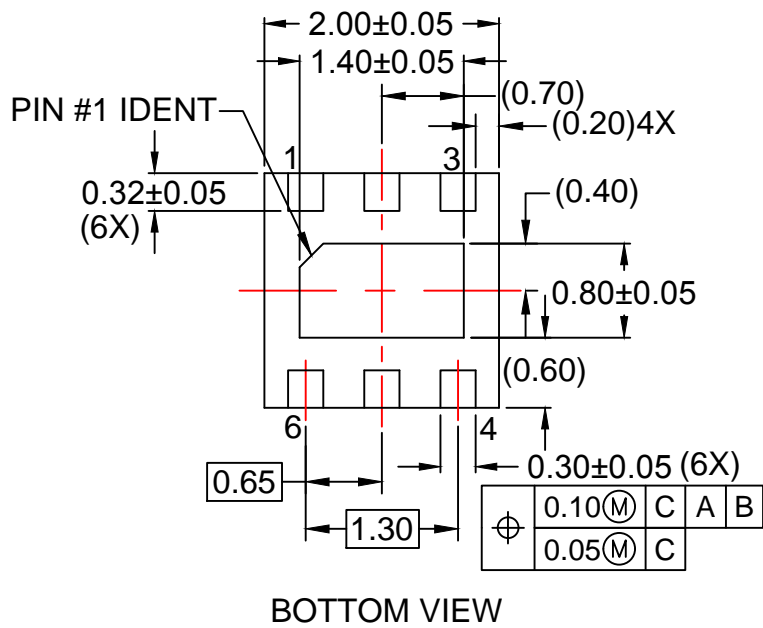
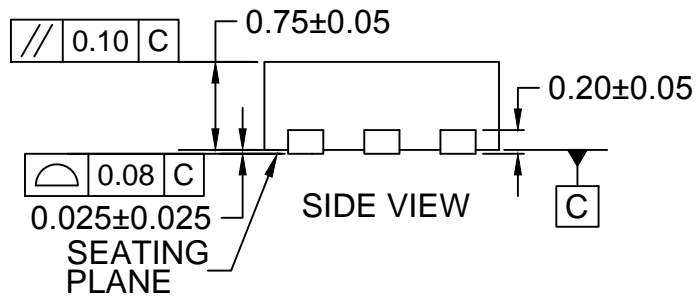
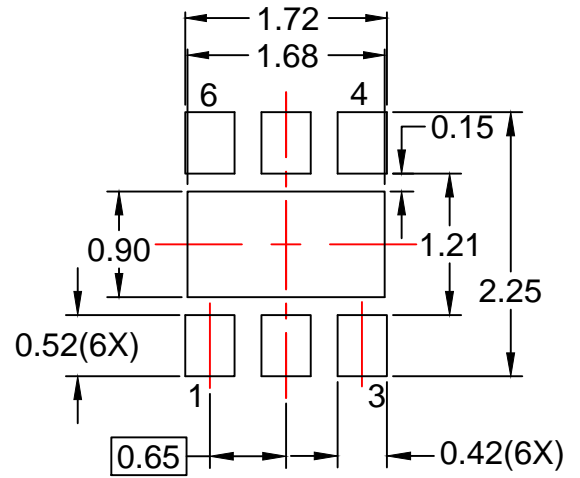
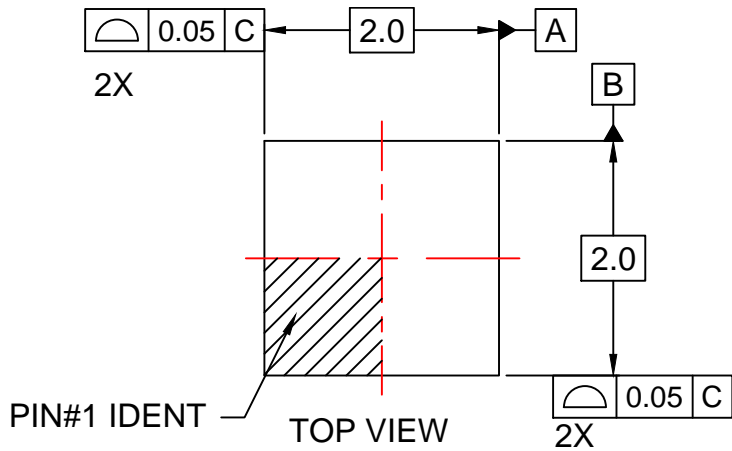

Figure 21. Demo board bottom layer view.



NOTES:

- A. PACKAGE DOES NOT FULLY CONFORM TO JEDEC MO-229 REGISTRATION
- B. DIMENSIONS ARE IN MILLIMETERS.
- C. DIMENSIONS AND TOLERANCES PER ASME Y14.5M, 2009.
- D. LAND PATTERN RECOMMENDATION IS EXISTING INDUSTRY LAND PATTERN.
- E. DRAWING FILENAME: MKT-MLP06Krev5.





**TRADEMARKS**

The following includes registered and unregistered trademarks and service marks, owned by Fairchild Semiconductor and/or its global subsidiaries, and is not intended to be an exhaustive list of all such trademarks.

AccuPower™  
AttitudeEngine™  
Awinda®  
AX-CAP®\*  
BitSiC™  
Build it Now™  
CorePLUS™  
CorePOWER™  
CROSSVOL™  
CTL™  
Current Transfer Logic™  
DEUXPEED®  
Dual Cool™  
EcoSPARK®  
EfficientMax™  
ESBC™  
F®  
Fairchild®  
Fairchild Semiconductor®  
FACT Quiet Series™  
FACT®  
FastvCore™  
FETBench™  
FPS™

F-PFS™  
FRFET®  
Global Power Resource™  
GreenBridge™  
Green FPS™  
Green FPS™ e-Series™  
Gmax™  
GTO™  
IntelliMAX™  
ISOPLANAR™  
Making Small Speakers Sound Louder and Better™  
MegaBuck™  
MICROCOUPLER™  
MicroFET™  
MicroPak™  
MicroPak2™  
MillerDrive™  
MotionMax™  
MotionGrid®  
MTi®  
MTx®  
MVN®  
mWSaver®  
OptoHiT™  
OPTOLOGIC®

OPTOPLANAR®  
Power Supply WebDesigner™  
PowerTrench®  
PowerXS™  
Programmable Active Droop™  
QFET®  
QS™  
Quiet Series™  
RapidConfigure™  
Saving our world, 1mW/W/kW at a time™  
SignalWise™  
SmartMax™  
SMART START™  
Solutions for Your Success™  
SPM®  
STEALTH™  
SuperFET®  
SuperSOT™-3  
SuperSOT™-6  
SuperSOT™-8  
SupreMOS®  
SyncFET™  
Sync-Lock™

SYSTEM GENERAL®  
TinyBoost®  
TinyBuck®  
TinyCalc™  
TinyLogic®  
TINYOPTO™  
TinyPower™  
TinyPWM™  
TinyWire™  
TranSiC™  
TriFault Detect™  
TRUECURRENT®\*  
µSerDes™  
SerDes®  
UHC®  
Ultra FRFET™  
UniFET™  
VCX™  
VisualMax™  
VoltagePlus™  
XS™  
Xsens™  
仙童®

\* Trademarks of System General Corporation, used under license by Fairchild Semiconductor.

**DISCLAIMER**

FAIRCHILD SEMICONDUCTOR RESERVES THE RIGHT TO MAKE CHANGES WITHOUT FURTHER NOTICE TO ANY PRODUCTS HEREIN TO IMPROVE RELIABILITY, FUNCTION, OR DESIGN. TO OBTAIN THE LATEST, MOST UP-TO-DATE DATASHEET AND PRODUCT INFORMATION, VISIT OUR WEBSITE AT [HTTP://WWW.FAIRCHILDSEMI.COM](http://www.fairchildsemi.com). FAIRCHILD DOES NOT ASSUME ANY LIABILITY ARISING OUT OF THE APPLICATION OR USE OF ANY PRODUCT OR CIRCUIT DESCRIBED HEREIN; NEITHER DOES IT CONVEY ANY LICENSE UNDER ITS PATENT RIGHTS, NOR THE RIGHTS OF OTHERS. THESE SPECIFICATIONS DO NOT EXPAND THE TERMS OF FAIRCHILD'S WORLDWIDE TERMS AND CONDITIONS, SPECIFICALLY THE WARRANTY THEREIN, WHICH COVERS THESE PRODUCTS.

**AUTHORIZED USE**

Unless otherwise specified in this data sheet, this product is a standard commercial product and is not intended for use in applications that require extraordinary levels of quality and reliability. This product may not be used in the following applications, unless specifically approved in writing by a Fairchild officer: (1) automotive or other transportation, (2) military/aerospace, (3) any safety critical application – including life critical medical equipment – where the failure of the Fairchild product reasonably would be expected to result in personal injury, death or property damage. Customer's use of this product is subject to agreement of this Authorized Use policy. In the event of an unauthorized use of Fairchild's product, Fairchild accepts no liability in the event of product failure. In other respects, this product shall be subject to Fairchild's Worldwide Terms and Conditions of Sale, unless a separate agreement has been signed by both Parties.

**ANTI-COUNTERFEITING POLICY**

Fairchild Semiconductor Corporation's Anti-Counterfeiting Policy. Fairchild's Anti-Counterfeiting Policy is also stated on our external website, [www.fairchildsemi.com](http://www.fairchildsemi.com), under Terms of Use

Counterfeiting of semiconductor parts is a growing problem in the industry. All manufacturers of semiconductor products are experiencing counterfeiting of their parts. Customers who inadvertently purchase counterfeit parts experience many problems such as loss of brand reputation, substandard performance, failed applications, and increased cost of production and manufacturing delays. Fairchild is taking strong measures to protect ourselves and our customers from the proliferation of counterfeit parts. Fairchild strongly encourages customers to purchase Fairchild parts either directly from Fairchild or from Authorized Fairchild Distributors who are listed by country on our web page cited above. Products customers buy either from Fairchild directly or from Authorized Fairchild Distributors are genuine parts, have full traceability, meet Fairchild's quality standards for handling and storage and provide access to Fairchild's full range of up-to-date technical and product information. Fairchild and our Authorized Distributors will stand behind all warranties and will appropriately address any warranty issues that may arise. Fairchild will not provide any warranty coverage or other assistance for parts bought from Unauthorized Sources. Fairchild is committed to combat this global problem and encourage our customers to do their part in stopping this practice by buying direct or from authorized distributors.

**PRODUCT STATUS DEFINITIONS**

**Definition of Terms**

Datasheet Identification	Product Status	Definition
Advance Information	Formative / In Design	Datasheet contains the design specifications for product development. Specifications may change in any manner without notice.
Preliminary	First Production	Datasheet contains preliminary data; supplementary data will be published at a later date. Fairchild Semiconductor reserves the right to make changes at any time without notice to improve design.
No Identification Needed	Full Production	Datasheet contains final specifications. Fairchild Semiconductor reserves the right to make changes at any time without notice to improve the design.
Obsolete	Not In Production	Datasheet contains specifications on a product that is discontinued by Fairchild Semiconductor. The datasheet is for reference information only.

# Mouser Electronics

Authorized Distributor

Click to View Pricing, Inventory, Delivery & Lifecycle Information:

[Fairchild Semiconductor:](#)

[FPF1005](#)