

**Photovoltaic Isolator
 Single and Dual Channel
 5-10 Volt Output**

General Description

The PVI Series Photovoltaic Isolator generates an electrically isolated DC voltage upon receipt of a DC input signal. It is capable of directly driving gates of power MOSFETs or IGBTs. It utilizes a monolithic integrated circuit photovoltaic generator of novel construction as its output. The output is controlled by radiation from a GaAlAs light emitting diode (LED), which is optically isolated from the photovoltaic generator.

The PVI Series is ideally suited for applications requiring high-current and/or high-voltage switching with optical isolation between the low-level driving circuitry and high-energy or high-voltage load circuits. It can be used for directly driving gates of power MOSFETs. The dual-channel device allows its outputs to drive independent discrete power MOSFETs, or be connected in parallel or in series to provide higher current drive for power MOSFETs or higher voltage drive for IGBTs. The PVI Series Photovoltaic isolators employ fast turn-off circuitry.

These PVI Series Photovoltaic Isolators are packaged in 8-pin, molded DIP packages and available with either thru-hole or surface-mount ("gull-wing") leads, in plastic shipping tubes.

Features

- Isolated Voltage Source
- Monolithic Construction
- Up to 8 μ A Output
- Single or Dual Output
- Solid-State Reliability

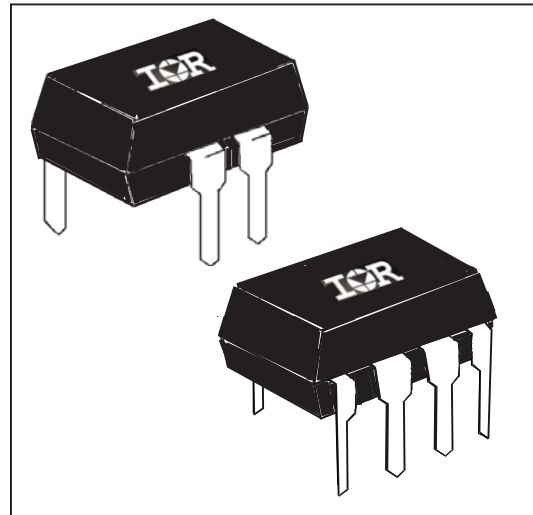

Applications

- Load Distribution
- Industrial Controls
- Current-to-Voltage Conversion
- Custom Solid-State Relay

Part Identification

PVI1050NPbF	
PVI5050NPbF	thru-hole
PVI5080NPbF	
PVI1050NSPbF	surface-mount
PVI5050NSPbF	(gull-wing)
PVI5080NSPbF	
PVI1050NS-TPbF	surface-mount, tape and reel

Electrical Specifications (-40°C ≤ T_A ≤ +85°C unless otherwise specified)

INPUT CHARACTERISTICS	PVI Series	Units
Input Current Range (see figure 4)	2.0 to 50	mA (DC)
Maximum Forward Voltage Drop @ 10mA, 25°C (see figure 5)	1.4	V (DC)
Maximum Reverse Voltage	6.0	V(DC)
Maximum Reverse Current @ -6.0V (DC), 25°C	100	μA(DC)
Maximum Pulsed Input Current @ 25°C (see figure 6)	1.0	A(peak)

OUTPUT CHARACTERISTICS	PVI Series	Units
Maximum Forward Voltage @ 10μA	8.0 per channel	V _(DC)
Maximum Reverse Current @ -10VDC	10	μA(DC)

COUPLED CHARACTERISTICS	PVI5050N	PVI5080N	PVI1050N	Units
Minimum Open Circuit Voltage @ I _{LED} = 10mA, 25°C, R _L = >10MΩ (see figures 1 to 2)	5.0		5.0/channel 10 series	V (DC)
Minimum Short Circuit Current @ I _{LED} = 10mA, 25°C (see figures 1 to 2)	5.0	8.0	5.0 /channel 10 parallel	μA (DC)
Maximum Capacitance (Input/Output)	1.0		2.0	pF
Maximum Ton Time @ I _{LED} =10mA, C _{LOAD} =10pF (See Figure7)	RL>20MΩ		300	μS
	RL=10MΩ		160	μS
	RL=4.7MΩ		90	μS
Maximum Toff Time @ I _{LED} =10mA, C _{LOAD} =10pF (See Figure7)	220			μS

GENERAL CHARACTERISTICS	PVI5050N/5080N	PVI1050N	Units
Min. Dielectric Strength, Input-Output	4000	2500	V _{RMS}
Min. Dielectric Strength, Output-to-Output	1200		V _{DC}
Min. Insulation Resistance, Input-to-Output @ T _A =+25°C, 50%RH, 100V _{DC}	10 ¹²		Ω
Max. Pin Soldering Temperature (10 seconds max.)	+260		°C
Ambient Temperature Range: Operating	-40 to +85		°C
	Storage		-40 to +125

International Rectifier does not recommend the use of this product in aerospace, avionics, military or life support applications. Users of this International Rectifier product in such applications assume all risks of such use and indemnify International Rectifier against all damages resulting from such use.

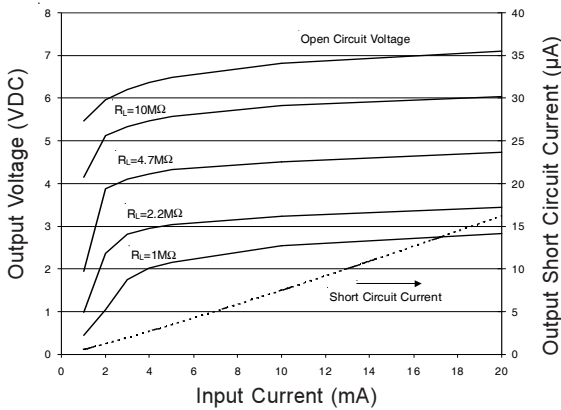

Figure 1. PVI5050N, PVI1050N Typical Output Characteristics

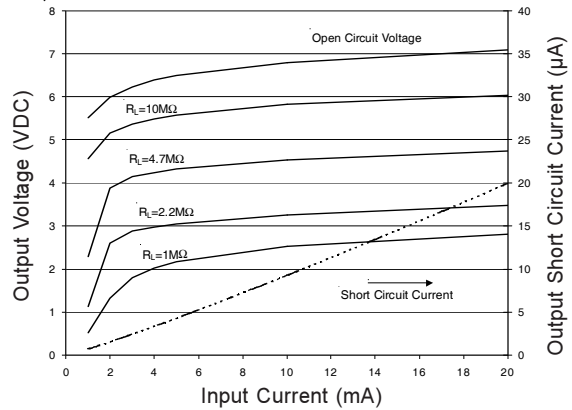

Figure 2. PVI5080N Typical Output Characteristics

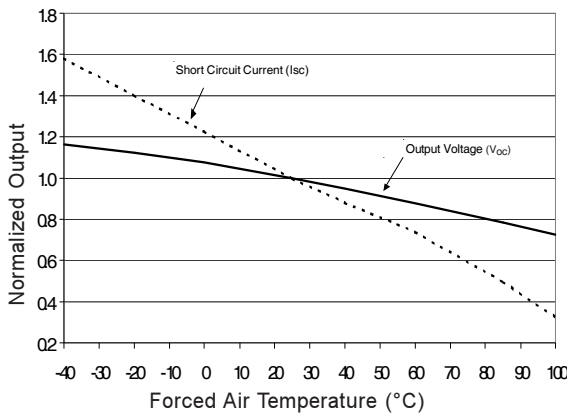

Figure 3. Typical Variation of Output

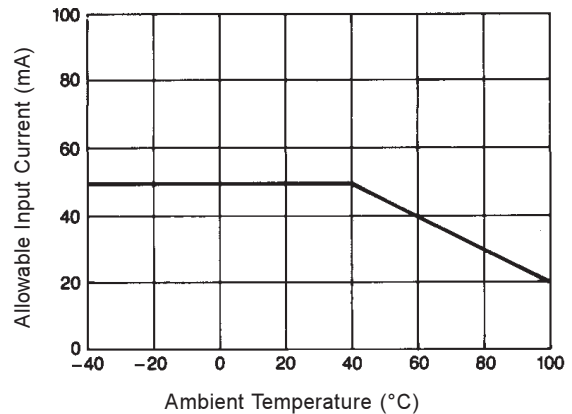

Figure 4. Input Current Derating

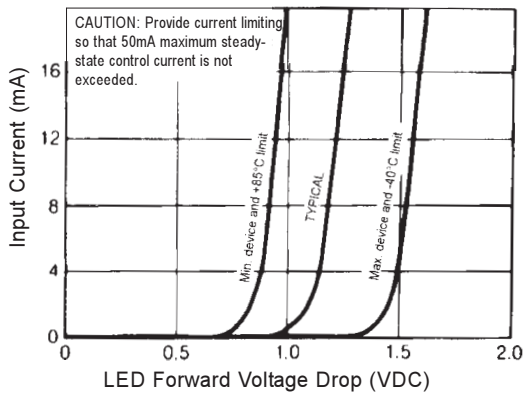

Figure 5. Input Characteristics

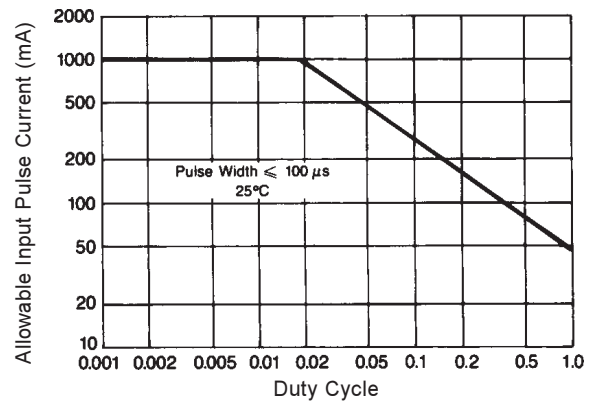

Figure 6. Input Pulse Capability

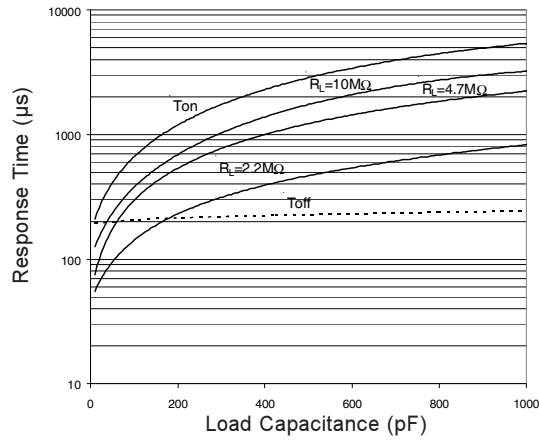
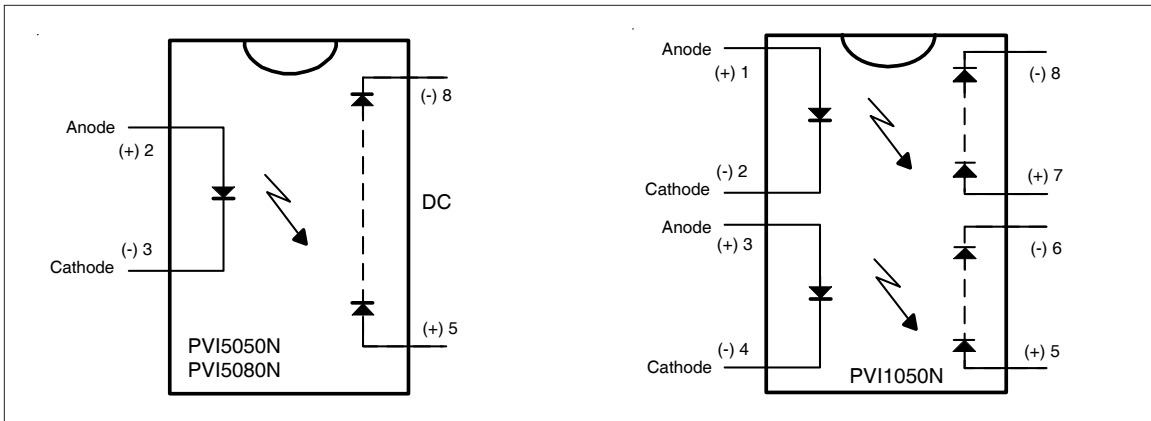

Figure 7. Typical Response Time

Wiring Diagram



Application Note:

The outputs of the PVI1050N (pins 5-6 and 7-8) may be placed in series connection to produce a 10-volt output with a 5µA minimum short circuit current. Alternatively, the two outputs of the PVI1050 may be connected in parallel to produce a 5.0-volt output with a 10µA minimum short circuit current.

The two outputs of the PVI1050N may be applied separately with a maximum 1200VDC between the outputs. Input-to-output isolation to either output is 2500V (RMS).

Case Outlines

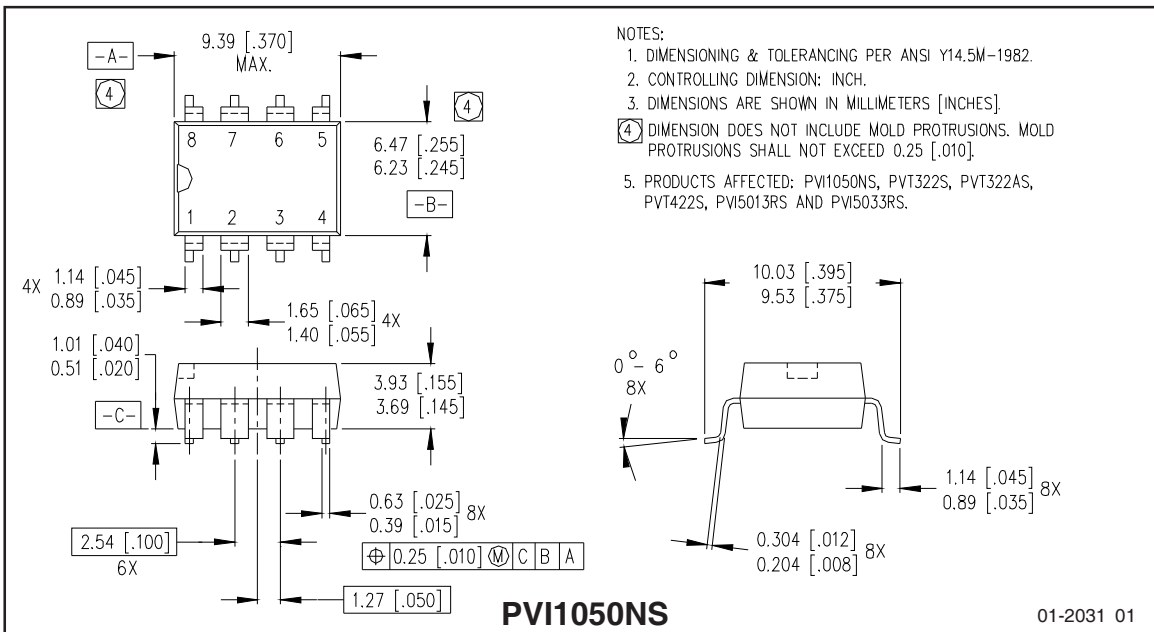
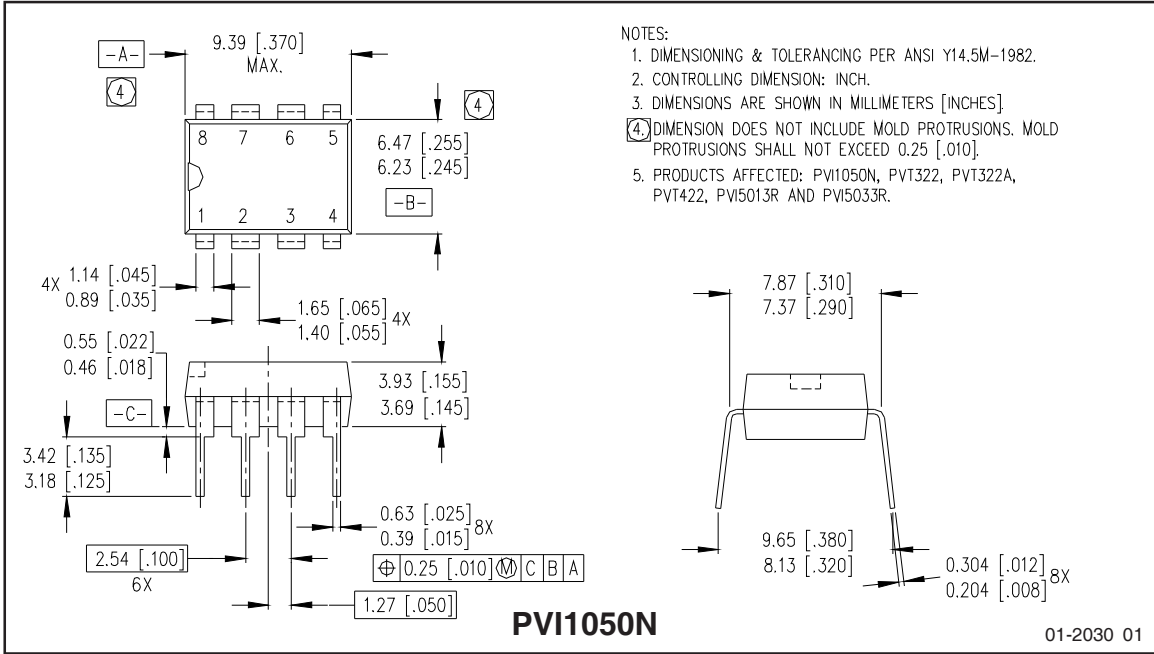

Note: For the most current drawing please refer to IR website at: <http://www.irf.com/package/>

Case Outlines

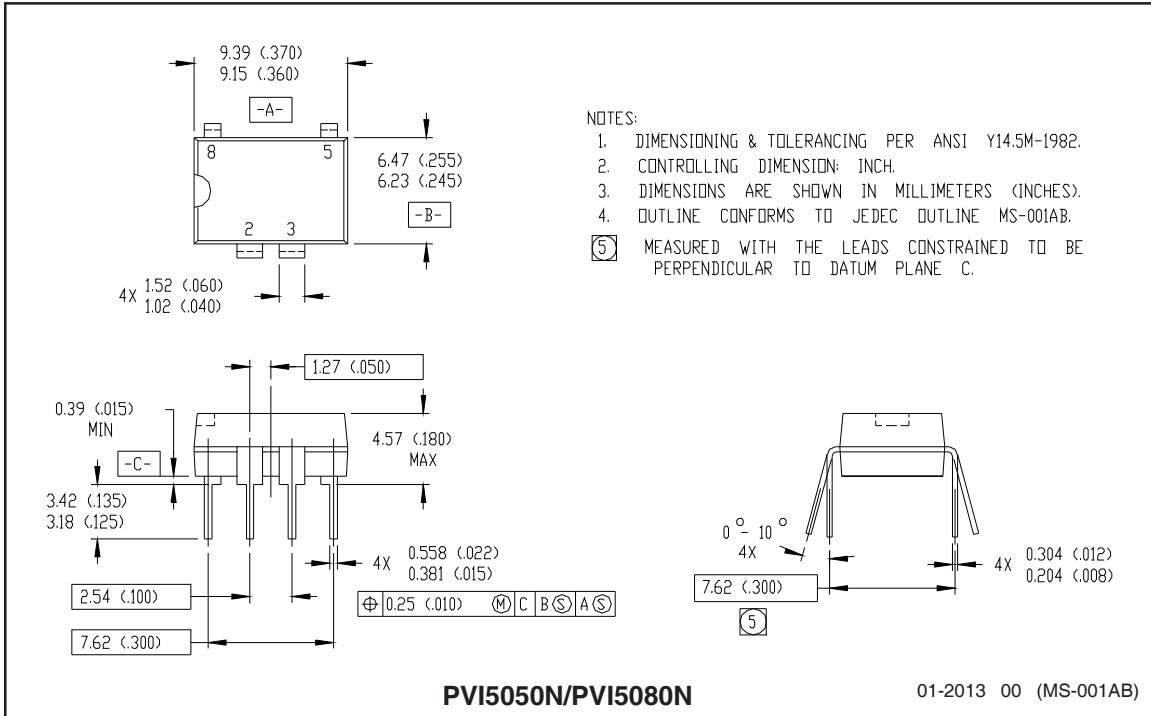

NOTES:

1. DIMENSIONING & TOLERANCING PER ANSI Y14.5M-1982.
2. CONTROLLING DIMENSION: INCH.
3. DIMENSIONS ARE SHOWN IN MILLIMETERS (INCHES).
4. OUTLINE CONFORMS TO JEDEC OUTLINE MS-001AB.

5 MEASURED WITH THE LEADS CONSTRAINED TO BE PERPENDICULAR TO DATUM PLANE C.

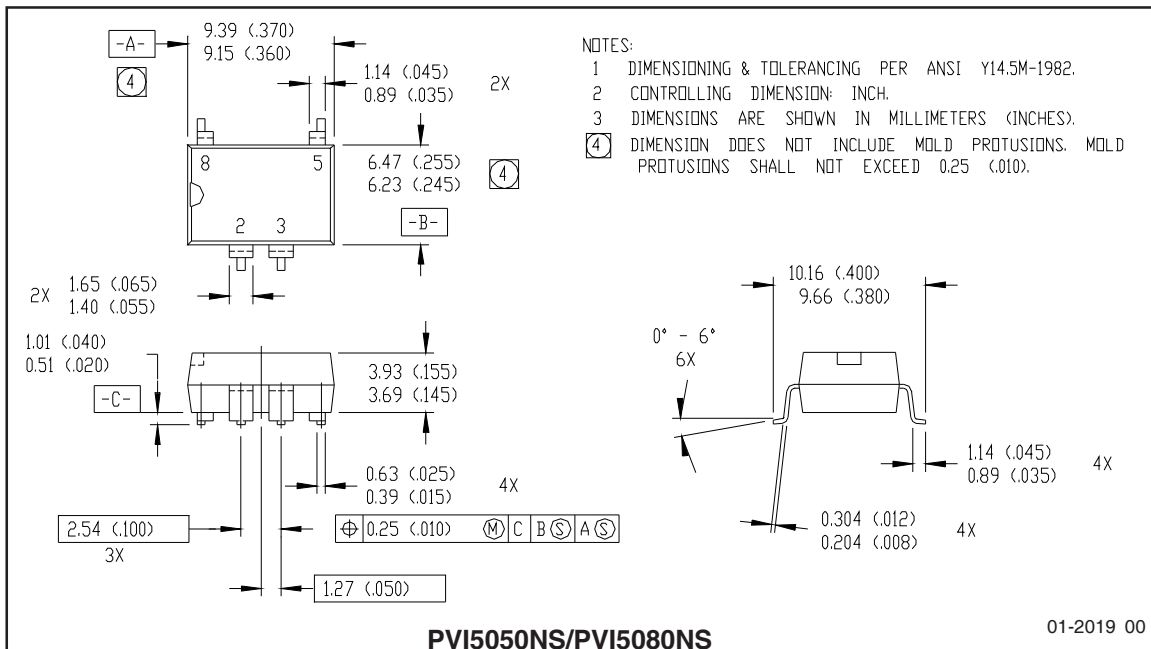

NOTES:

- 1 DIMENSIONING & TOLERANCING PER ANSI Y14.5M-1982.
- 2 CONTROLLING DIMENSION: INCH.
- 3 DIMENSIONS ARE SHOWN IN MILLIMETERS (INCHES).
- 4 DIMENSION DOES NOT INCLUDE MOLD PROTUSIONS. MOLD PROTUSIONS SHALL NOT EXCEED 0.25 (.010).

Note: For the most current drawing please refer to IR website at: <http://www.irf.com/package/>

Qualification information[†]

Qualification level	Indusrid (per JEDEC JESD47 ^{††} guidelines)	
Moisture Sensitivity Level	PVI1050NPbF	N/A
	PVI5050NPbF	
	PVI5080NPbF	
	PVI1050NSPbF	MSL4 (per JEDEC J-STD-020E & JEDEC J-STD-033C ^{††})
	PVI5050NSPbF	
	PVI5080NSPbF	
	PVI1050NS-TPbF	
RoHS compliant	Yes	

† Qualification standards can be found at International Rectifier's web site
<http://www.irf.com/product-info/reliability>

†† Applicable version of JEDEC standard at the time of product release.

Revision History

Date	Comment
4/24/2015	<ul style="list-style-type: none"> Added Qualification Information table on page 7. Updated data sheet based on corporate template.

Mouser Electronics

Authorized Distributor

Click to View Pricing, Inventory, Delivery & Lifecycle Information:

International Rectifier:

[PVI1050NPBF](#) [PVI1050NS-TPBF](#) [PVI5050NPBF](#) [PVI5050NSPBF](#) [PVI5080NPBF](#) [PVI5080NSPBF](#) [PVI1050NSPBF](#)