

**HiPerFRED<sup>2</sup>**

|           |   |      |
|-----------|---|------|
| $V_{RRM}$ | = | 400V |
| $I_{FAV}$ | = | 60A  |
| $t_{rr}$  | = | 45ns |

High Performance Fast Recovery Diode  
 Low Loss and Soft Recovery  
 Single Diode

Part number

**DPG60I400HA**

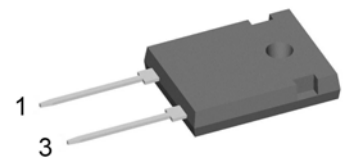

Backside: cathode

**Features / Advantages:**

- Planar passivated chips
- Very low leakage current
- Very short recovery time
- Improved thermal behaviour
- Very low  $I_{rm}$ -values
- Very soft recovery behaviour
- Avalanche voltage rated for reliable operation
- Soft reverse recovery for low EMI/RFI
- Low  $I_{rm}$  reduces:
  - Power dissipation within the diode
  - Turn-on loss in the commutating switch

**Applications:**

- Antiparallel diode for high frequency switching devices
- Antisaturation diode
- Snubber diode
- Free wheeling diode
- Rectifiers in switch mode power supplies (SMPS)
- Uninterruptible power supplies (UPS)

**Package: TO-247**

- Industry standard outline
- RoHS compliant
- Epoxy meets UL 94V-0

| Fast Diode |  |   |                         | Ratings |      |            |
|------------|--|---|-------------------------|---------|------|------------|
| Symbol     | Definition                                   | Conditions  | min.                    | typ.    | max. | Unit       |
| $V_{RSM}$  | max. non-repetitive reverse blocking voltage | $T_{VJ} = 25^{\circ}C$                                  |                         |         | 400  | V          |
| $V_{RRM}$  | max. repetitive reverse blocking voltage     | $T_{VJ} = 25^{\circ}C$                                  |                         |         | 400  | V          |
| $I_R$      | reverse current, drain current               | $V_R = 400 V$   | $T_{VJ} = 25^{\circ}C$  |         | 1    | $\mu A$    |
|            |  | $V_R = 400 V$   | $T_{VJ} = 150^{\circ}C$ |         | 0.3  | mA         |
| $V_F$      | forward voltage drop                         | $I_F = 60 A$  | $T_{VJ} = 25^{\circ}C$  |         | 1.47 | V          |
|            |  | $I_F = 120 A$   |                         |         | 1.80 | V          |
|            |  | $I_F = 60 A$  | $T_{VJ} = 150^{\circ}C$ |         | 1.22 | V          |
|            |  | $I_F = 120 A$   |                         |         | 1.59 | V          |
| $I_{FAV}$  | average forward current                      | $T_C = 125^{\circ}C$<br>rectangular $d = 0.5$           | $T_{VJ} = 175^{\circ}C$ |         | 60   | A          |
| $V_{FO}$   | threshold voltage                            | } for power loss calculation only                       | $T_{VJ} = 175^{\circ}C$ |         | 0.81 | V          |
| $r_F$      | slope resistance                             |   |                         |         | 6.1  | m $\Omega$ |
| $R_{thJC}$ | thermal resistance junction to case          |   |                         |         | 0.55 | K/W        |
| $R_{thCH}$ | thermal resistance case to heatsink          |   |                         | 0.25    |      | K/W        |
| $P_{tot}$  | total power dissipation                      |   | $T_C = 25^{\circ}C$     |         | 275  | W          |
| $I_{FSM}$  | max. forward surge current                   | $t = 10 ms; (50 Hz), sine; V_R = 0 V$                   | $T_{VJ} = 45^{\circ}C$  |         | 450  | A          |
| $C_J$      | junction capacitance                         | $V_R = 200 V$ $f = 1 MHz$                               | $T_{VJ} = 25^{\circ}C$  |         | 61   | pF         |
| $I_{RM}$   | max. reverse recovery current                | } $I_F = 60 A; V_R = 270 V$<br>$-di_F/dt = 200 A/\mu s$ | $T_{VJ} = 25^{\circ}C$  |         | 4    | A          |
| $t_{rr}$   | reverse recovery time                        |   | $T_{VJ} = 125^{\circ}C$ |         | 9.5  | A          |
|            |  |   | $T_{VJ} = 25^{\circ}C$  |         | 45   | ns         |
|            |  |   | $T_{VJ} = 125^{\circ}C$ |         | 85   | ns         |

| Package TO-247 |                              |              | Ratings |      |      |      |
|----------------|------------------------------|--------------|---------|------|------|------|
| Symbol         | Definition                   | Conditions   | min.    | typ. | max. | Unit |
| $I_{RMS}$      | RMS current                  | per terminal |         |      | 70   | A    |
| $T_{VJ}$       | virtual junction temperature |              | -55     |      | 175  | °C   |
| $T_{op}$       | operation temperature        |              | -55     |      | 150  | °C   |
| $T_{stg}$      | storage temperature          |              | -55     |      | 150  | °C   |
| <b>Weight</b>  |                              |              |         | 6    |      | g    |
| $M_D$          | mounting torque              |              | 0.8     |      | 1.2  | Nm   |
| $F_C$          | mounting force with clip     |              | 20      |      | 120  | N    |

### Product Marking

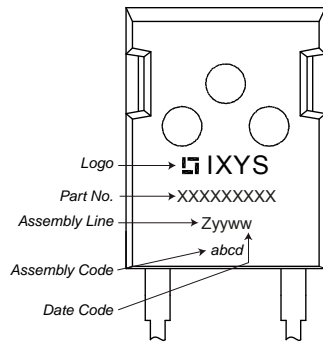

### Part number

- D = Diode
- P = HiPerFRED
- G = extreme fast
- 60 = Current Rating [A]
- I = Single Diode
- 400 = Reverse Voltage [V]
- HA = TO-247AD (2)

| Ordering | Part Number | Marking on Product | Delivery Mode | Quantity | Code No. |
|----------|-------------|--------------------|---------------|----------|----------|
| Standard | DPG60I400HA | DPG60I400HA        | Tube          | 30       | 506242   |

| Similar Part | Package   | Voltage class |
|--------------|-----------|---------------|
| DPG60IM400QB | TO-3P (3) | 400           |

### Equivalent Circuits for Simulation

\* on die level

$T_{VJ} = 175\text{ °C}$

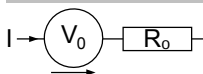

**Fast Diode**

|              |                    |      |    |
|--------------|--------------------|------|----|
| $V_{0\ max}$ | threshold voltage  | 0.81 | V  |
| $R_{0\ max}$ | slope resistance * | 3.5  | mΩ |

## Outlines TO-247

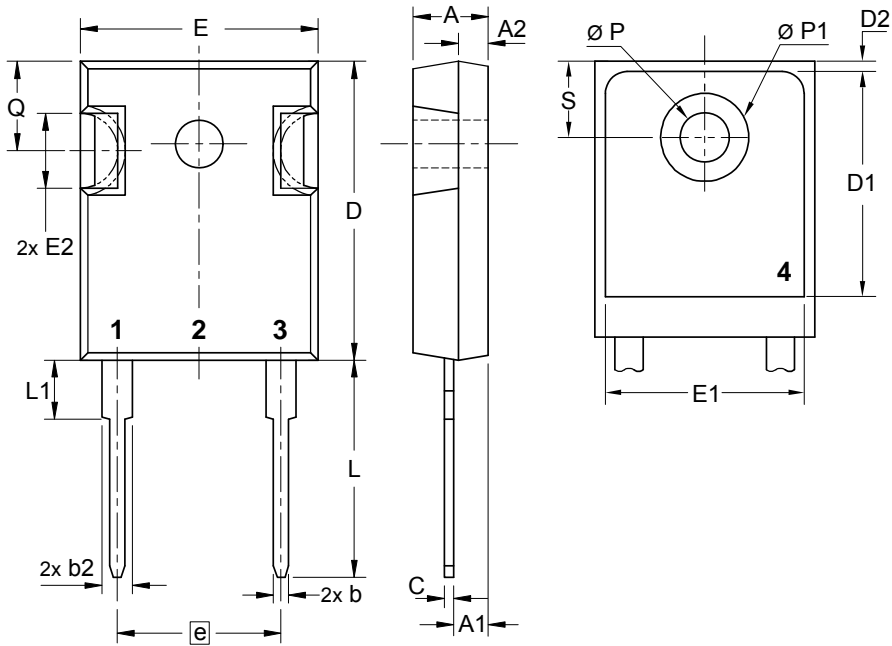

| Sym. | Inches    |       | Millimeter |       |
|------|-----------|-------|------------|-------|
|      | min.      | max.  | min.       | max.  |
| A    | 0.185     | 0.209 | 4.70       | 5.30  |
| A1   | 0.087     | 0.102 | 2.21       | 2.59  |
| A2   | 0.059     | 0.098 | 1.50       | 2.49  |
| D    | 0.819     | 0.845 | 20.79      | 21.45 |
| E    | 0.610     | 0.640 | 15.48      | 16.24 |
| E2   | 0.170     | 0.216 | 4.31       | 5.48  |
| e    | 0.430 BSC |       | 10.92 BSC  |       |
| L    | 0.780     | 0.800 | 19.80      | 20.30 |
| L1   | -         | 0.177 | -          | 4.49  |
| Ø P  | 0.140     | 0.144 | 3.55       | 3.65  |
| Q    | 0.212     | 0.244 | 5.38       | 6.19  |
| S    | 0.242 BSC |       | 6.14 BSC   |       |
| b    | 0.039     | 0.055 | 0.99       | 1.40  |
| b2   | 0.065     | 0.094 | 1.65       | 2.39  |
| b4   | 0.102     | 0.135 | 2.59       | 3.43  |
| c    | 0.015     | 0.035 | 0.38       | 0.89  |
| D1   | 0.515     | -     | 13.07      | -     |
| D2   | 0.020     | 0.053 | 0.51       | 1.35  |
| E1   | 0.530     | -     | 13.45      | -     |
| Ø P1 | -         | 0.29  | -          | 7.39  |



## Fast Diode

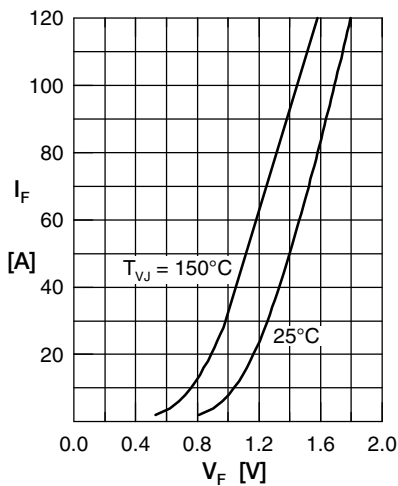

Fig. 1 Forward current  $I_F$  versus  $V_F$

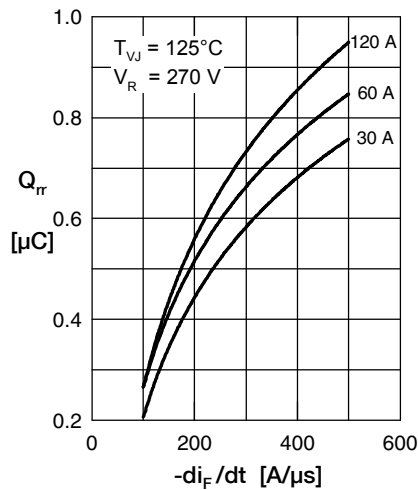

Fig. 2 Typ. reverse recov. charge  $Q_{rr}$  versus  $-di_F/dt$

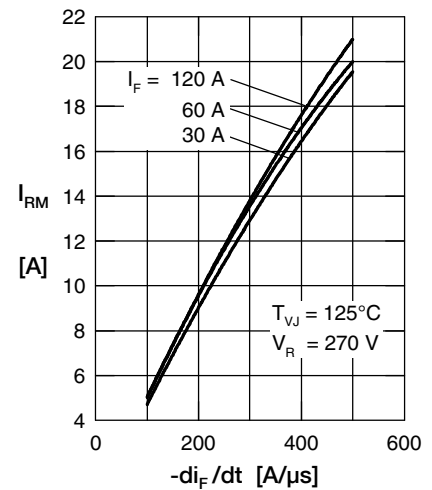

Fig. 3 Typ. reverse recov. current  $I_{RM}$  versus  $-di_F/dt$

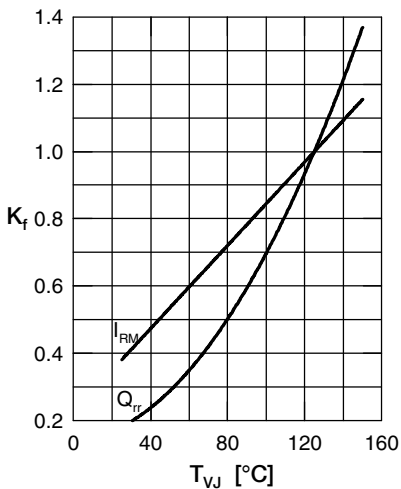

Fig. 4 Typ. dynamic parameters  $Q_{rr}$ ,  $I_{RM}$  versus  $T_{VJ}$

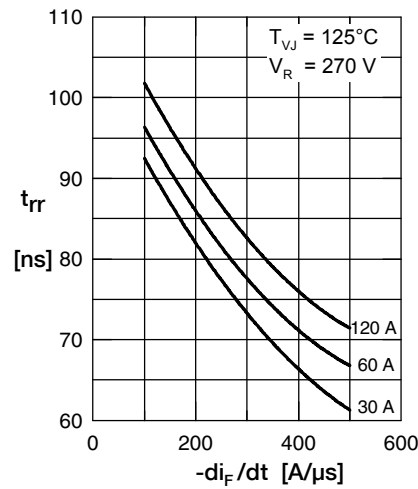

Fig. 5 Typ. reverse recov. time  $t_{rr}$  versus  $-di_F/dt$

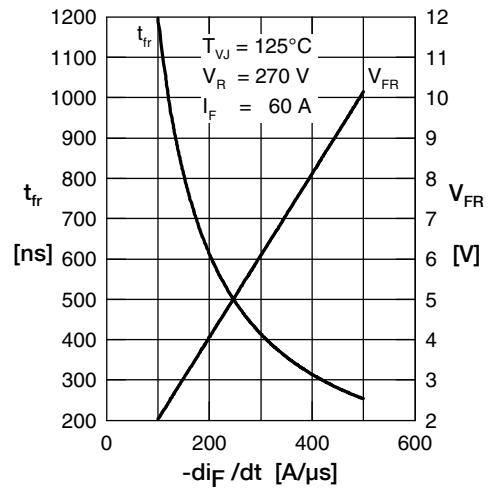

Fig. 6 Typ. forward recovery voltage  $V_{FR}$  & time  $t_{fr}$  versus  $di_F/dt$

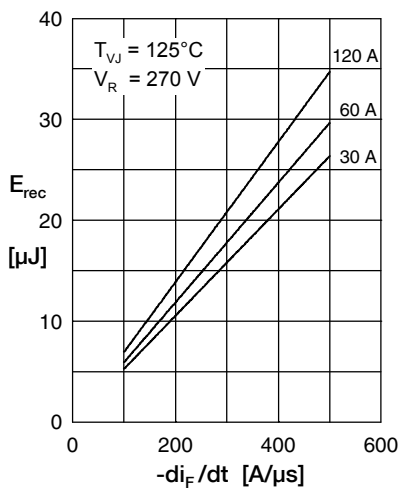

Fig. 7 Typ. recovery energy  $E_{rec}$  versus  $-di_F/dt$

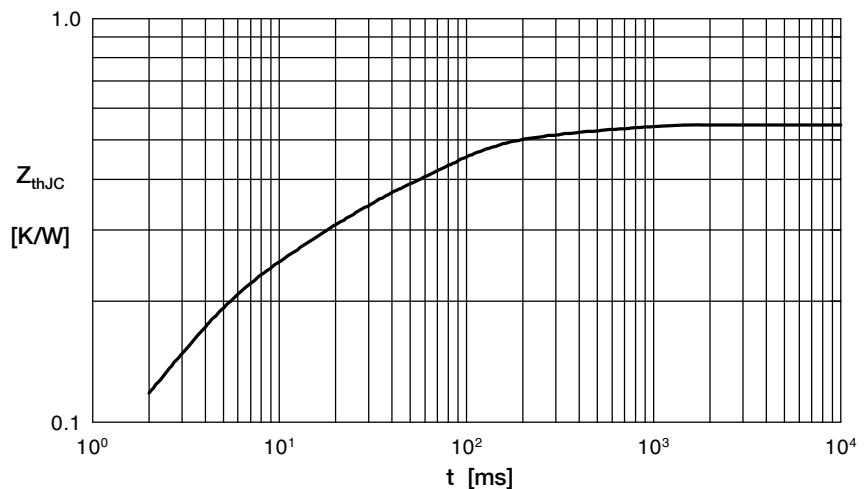

Fig. 8 Transient thermal impedance junction to case

# Mouser Electronics

Authorized Distributor

Click to View Pricing, Inventory, Delivery & Lifecycle Information:

[IXYS:](#)

[DPG60I400HA](#)