

**Polar™ HiPerFET™
Power MOSFETs**

**IXFK40N90P
IXFX40N90P**

N-Channel Enhancement Mode
Avalanche Rated
Fast Intrinsic Rectifier

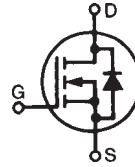

$V_{DSS} = 900V$
 $I_{D25} = 40A$
 $R_{DS(on)} \leq 230m\Omega$
 $t_{rr} \leq 300ns$

Symbol	Test Conditions	Maximum Ratings	
V_{DSS}	$T_J = 25^\circ C$ to $150^\circ C$	900	V
V_{DGR}	$T_J = 25^\circ C$ to $150^\circ C$, $R_{GS} = 1M\Omega$	900	V
V_{GSS}	Continuous	± 30	V
V_{GSM}	Transient	± 40	V
I_{D25}	$T_C = 25^\circ C$	40	A
I_{DM}	$T_C = 25^\circ C$, Pulse Width Limited by T_{JM}	80	A
I_A	$T_C = 25^\circ C$	20	A
E_{AS}	$T_C = 25^\circ C$	2.5	J
dv/dt	$I_S \leq I_{DM}$, $V_{DD} \leq V_{DSS}$, $T_J \leq 150^\circ C$	15	V/ns
P_D	$T_C = 25^\circ C$	960	W
T_J		-55 to +150	$^\circ C$
T_{JM}		150	$^\circ C$
T_{stg}		-55 to +150	$^\circ C$
T_L	1.6mm (0.062 in.) from Case for 10s	300	$^\circ C$
T_{SOLD}	Plastic Body for 10s	260	$^\circ C$
M_d	Mounting Torque (TO-264)	1.13/10	Nm/lb.in.
F_C	Mounting Force (PLUS247)	20..120 / 4.5..27	N/lb.
Weight	TO-264	10	g
	PLUS247	6	g

TO-264 (IXFK)

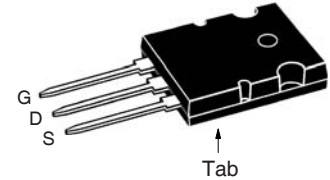

PLUS247 (IXFX)

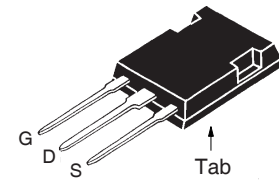

G = Gate D = Drain
S = Source Tab = Drain

Features

- Low $R_{DS(on)}$ and Q_G
- Avalanche Rated
- Low Package Inductance
- Fast Intrinsic Rectifier

Advantages

- High Power Density
- Easy to Mount
- Space Savings

Applications

- Switch-Mode and Resonant-Mode Power Supplies
- DC-DC Converters
- Laser Drivers
- AC and DC Motor Drives
- Robotics and Servo Controls

Symbol	Test Conditions ($T_J = 25^\circ C$, Unless Otherwise Specified)	Characteristic Values		
		Min.	Typ.	Max.
BV_{DSS}	$V_{GS} = 0V$, $I_D = 3mA$	900		V
$V_{GS(th)}$	$V_{DS} = V_{GS}$, $I_D = 1mA$	3.5		6.5 V
I_{GSS}	$V_{GS} = \pm 30V$, $V_{DS} = 0V$			± 200 nA
I_{DSS}	$V_{DS} = V_{DSS}$, $V_{GS} = 0V$ $T_J = 125^\circ C$			50 μA 3.5 mA
$R_{DS(on)}$	$V_{GS} = 10V$, $I_D = 0.5 \cdot I_{D25}$, Note 1			230 m Ω

Symbol	Test Conditions ($T_J = 25^\circ\text{C}$, Unless Otherwise Specified)	Characteristic Values		
		Min.	Typ.	Max.
g_{fs}	$V_{DS} = 20\text{V}$, $I_D = 0.5 \cdot I_{D25}$, Note 1	18	30	S
C_{iss}	$V_{GS} = 0\text{V}$, $V_{DS} = 25\text{V}$, $f = 1\text{MHz}$		14	nF
C_{oss}			896	pF
C_{rss}			58	pF
R_{Gi}	Gate Input Resistance		1.5	Ω
$t_{d(on)}$	Resistive Switching Times $V_{GS} = 10\text{V}$, $V_{DS} = 0.5 \cdot V_{DSS}$, $I_D = 0.5 \cdot I_{D25}$ $R_G = 1\Omega$ (External)		53	ns
t_r			50	ns
$t_{d(off)}$			77	ns
t_f			46	ns
$Q_{g(on)}$	$V_{GS} = 10\text{V}$, $V_{DS} = 0.5 \cdot V_{DSS}$, $I_D = 0.5 \cdot I_{D25}$		230	nC
Q_{gs}			70	nC
Q_{gd}			100	nC
R_{thJC}			0.13	$^\circ\text{C/W}$
R_{thCS}		0.15		$^\circ\text{C/W}$

Source-Drain Diode

Symbol	Test Conditions ($T_J = 25^\circ\text{C}$, Unless Otherwise Specified)	Characteristic Values		
		Min.	Typ.	Max.
I_S	$V_{GS} = 0\text{V}$			40 A
I_{SM}	Repetitive, Pulse Width Limited by T_{JM}			160 A
V_{SD}	$I_F = I_S$, $V_{GS} = 0\text{V}$, Note 1			1.5 V
t_{rr}	$I_F = 20\text{A}$, $-di/dt = 100\text{A}/\mu\text{s}$, $V_R = 100\text{V}$, $V_{GS} = 0\text{V}$		14.0	ns
I_{RM}			1.7	A
Q_{RM}				μC

Note: 1. Pulse test, $t \leq 300\mu\text{s}$, duty cycle, $d \leq 2\%$.

TO-264 Outline

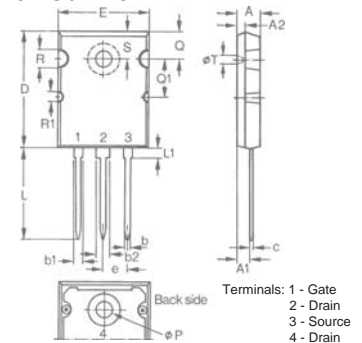

Dim.	Millimeter		Inches	
	Min.	Max.	Min.	Max.
A	4.82	5.13	.190	.202
A1	2.54	2.89	.100	.114
A2	2.00	2.10	.079	.083
b	1.12	1.42	.044	.056
b1	2.39	2.69	.094	.106
b2	2.90	3.09	.114	.122
c	0.53	0.83	.021	.033
D	25.91	26.16	1.020	1.030
E	19.81	19.96	.780	.786
e	5.46 BSC		.215 BSC	
J	0.00	0.25	.000	.010
K	0.00	0.25	.000	.010
L	20.32	20.83	.800	.820
L1	2.29	2.59	.090	.102
P	3.17	3.66	.125	.144
Q	6.07	6.27	.239	.247
Q1	8.38	8.69	.330	.342
R	3.81	4.32	.150	.170
R1	1.78	2.29	.070	.090
S	6.04	6.30	.238	.248
T	1.57	1.83	.062	.072

PLUS247™ Outline

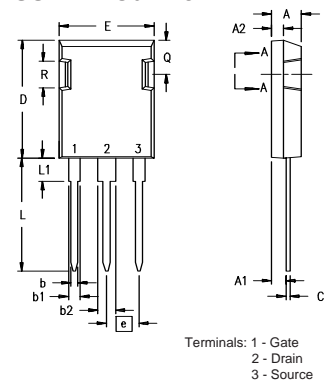

Dim.	Millimeter		Inches	
	Min.	Max.	Min.	Max.
A	4.83	5.21	.190	.205
A ₁	2.29	2.54	.090	.100
A ₂	1.91	2.16	.075	.085
b	1.14	1.40	.045	.055
b ₁	1.91	2.13	.075	.084
b ₂	2.92	3.12	.115	.123
C	0.61	0.80	.024	.031
D	20.80	21.34	.819	.840
E	15.75	16.13	.620	.635
e	5.45 BSC		.215 BSC	
L	19.81	20.32	.780	.800
L1	3.81	4.32	.150	.170
Q	5.59	6.20	.220	0.244
R	4.32	4.83	.170	.190

IXYS Reserves the Right to Change Limits, Test Conditions, and Dimensions.

IXYS MOSFETs and IGBTs are covered by one or more of the following U.S. patents:	4,835,592	4,931,844	5,049,961	5,237,481	6,162,665	6,404,065 B1	6,683,344	6,727,585	7,005,734 B2	7,157,338B2
	4,850,072	5,017,508	5,063,307	5,381,025	6,259,123 B1	6,534,343	6,710,405 B2	6,759,692	7,063,975 B2	
	4,881,106	5,034,796	5,187,117	5,486,715	6,306,728 B1	6,583,505	6,710,463	6,771,478 B2	7,071,537	

Fig. 1. Output Characteristics @ $T_J = 25^\circ\text{C}$

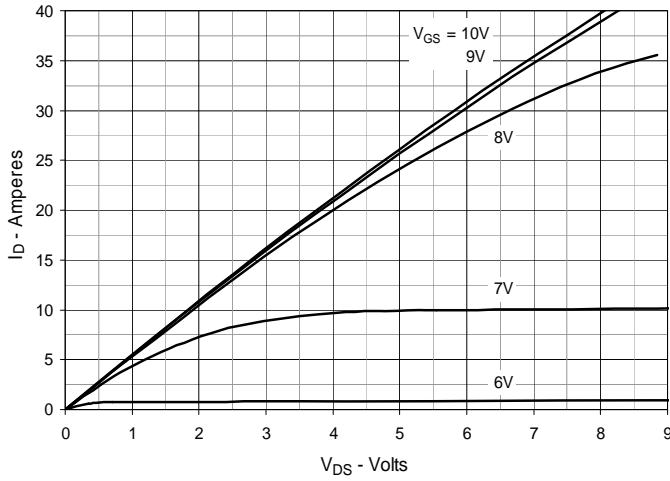

Fig. 2. Extended Output Characteristics @ $T_J = 25^\circ\text{C}$

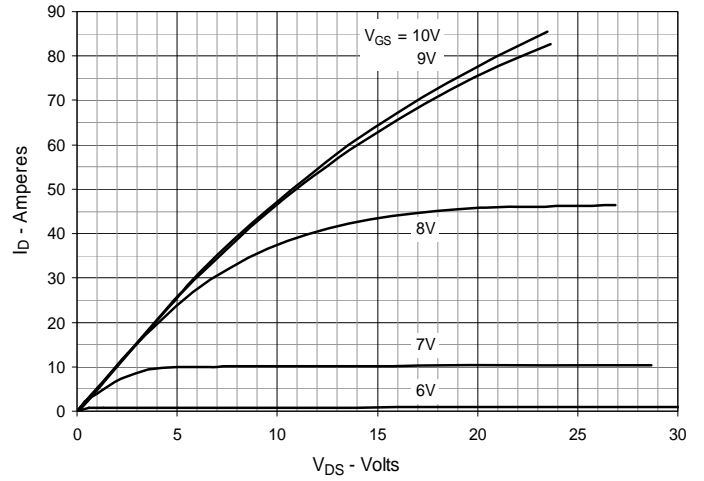

Fig. 3. Output Characteristics @ $T_J = 125^\circ\text{C}$

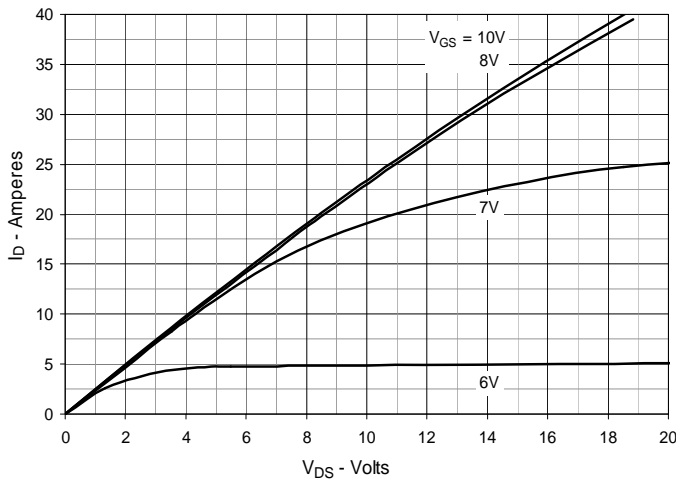

Fig. 4. $R_{DS(on)}$ Normalized to $I_D = 20A$ Value vs. Junction Temperature

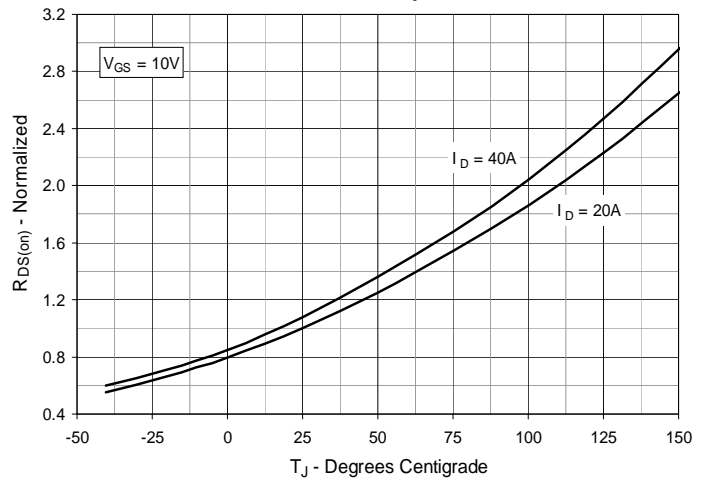

Fig. 5. $R_{DS(on)}$ Normalized to $I_D = 20A$ Value vs. Drain Current

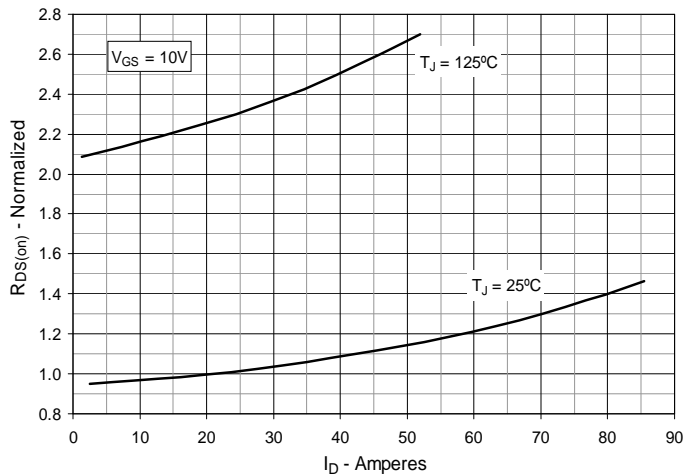

Fig. 6. Maximum Drain Current vs. Case Temperature

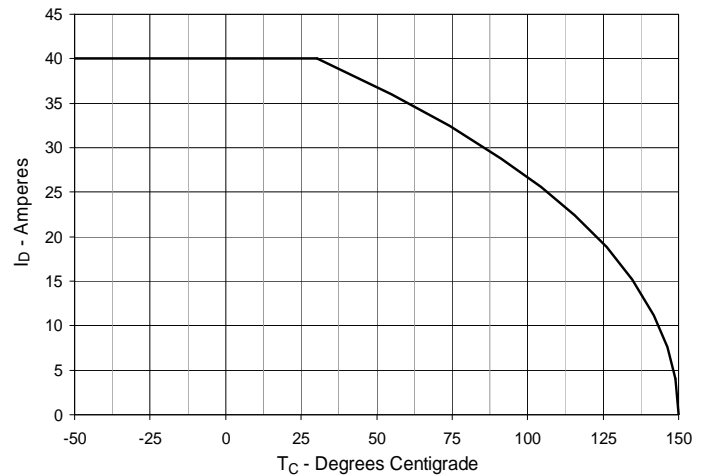

Fig. 7. Input Admittance

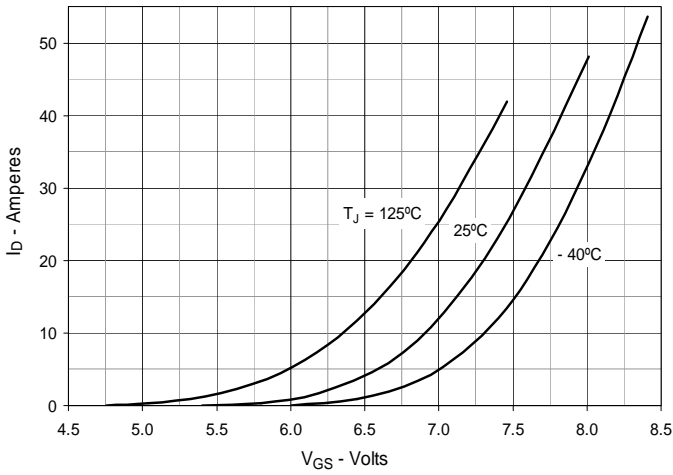

Fig. 8. Transconductance

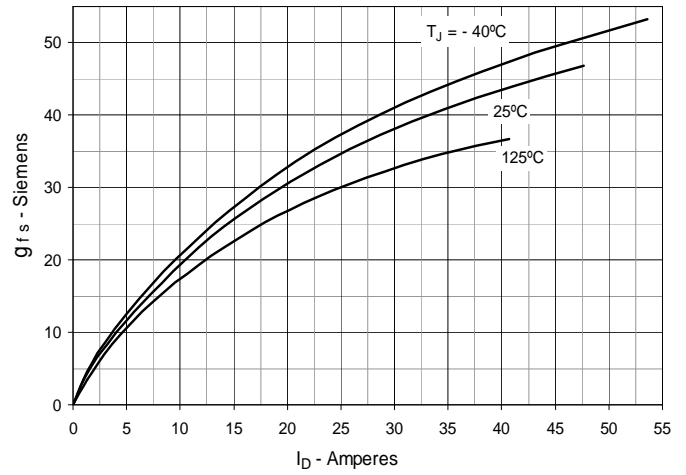

Fig. 9. Forward Voltage Drop of Intrinsic Diode

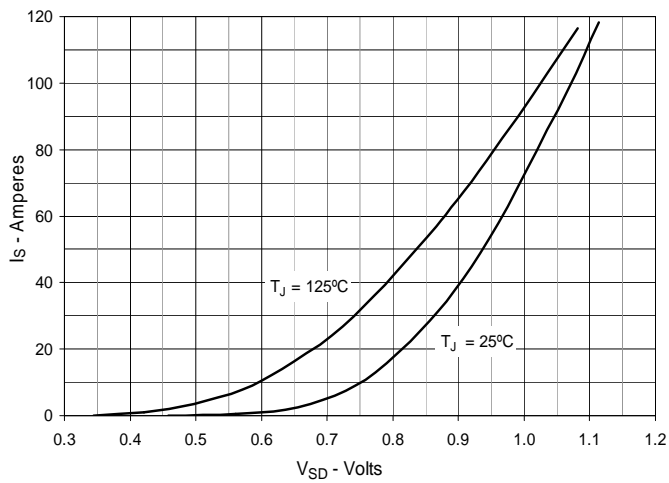

Fig. 10. Gate Charge

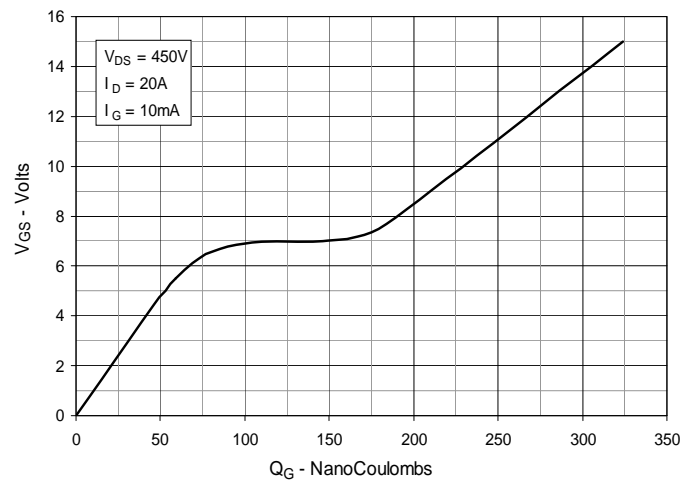

Fig. 11. Capacitance

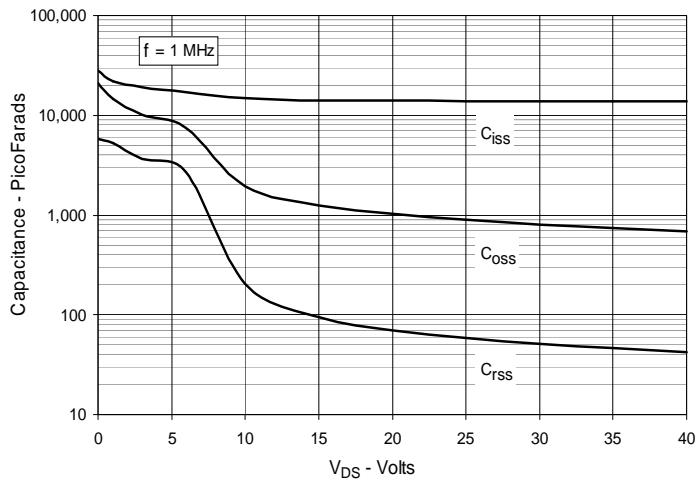
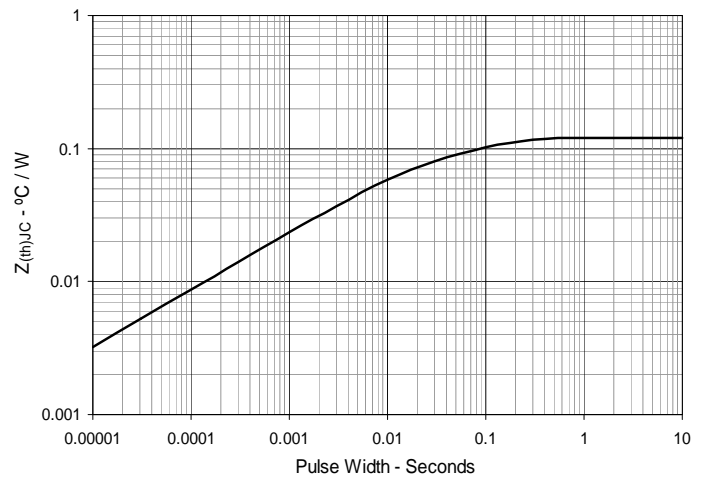

Fig. 12. Maximum Transient Thermal Impedance



Mouser Electronics

Authorized Distributor

Click to View Pricing, Inventory, Delivery & Lifecycle Information:

[IXYS:](#)

[IXFK40N90P](#) [IXFX40N90P](#)