

PolarP™
Power MOSFETs

IXTK90P20P
IXTX90P20P

$V_{DSS} = -200V$
 $I_{D25} = -90A$
 $R_{DS(on)} \leq 44m\Omega$

P-Channel Enhancement Mode
Avalanche Rated

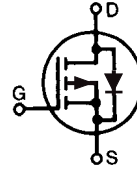

Symbol	Test Conditions	Maximum Ratings	
V_{DSS}	$T_J = 25^\circ C$ to $150^\circ C$	- 200	V
V_{DGR}	$T_J = 25^\circ C$ to $150^\circ C$, $R_{GS} = 1M\Omega$	- 200	V
V_{GSS}	Continuous	± 20	V
V_{GSM}	Transient	± 30	V
I_{D25}	$T_C = 25^\circ C$	- 90	A
I_{DM}	$T_C = 25^\circ C$, Pulse Width Limited by T_{JM}	- 270	A
I_A	$T_C = 25^\circ C$	- 90	A
E_{AS}	$T_C = 25^\circ C$	3.5	J
dv/dt	$I_S \leq I_{DM}$, $V_{DD} \leq V_{DSS}$, $T_J \leq 150^\circ C$	10	V/ns
P_D	$T_C = 25^\circ C$	890	W
T_J		-55 ... +150	$^\circ C$
T_{JM}		150	$^\circ C$
T_{stg}		-55 ... +150	$^\circ C$
T_L	1.6mm (0.062 in.) from Case for 10s	300	$^\circ C$
T_{SOLD}	Plastic Body for 10s	260	$^\circ C$
M_d	Mounting Force (PLUS247)	20..120 / 4.5..27	N/lb.
	Mounting Torque (TO-264)	1.13 / 10	Nm/lb.in.
Weight	PLUS247	6	g
	TO-264	10	g

TO-264 (IXTK)

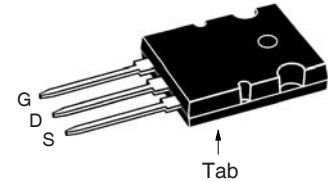

PLUS247 (IXTX)

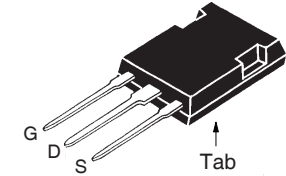

G = Gate D = Drain
S = Source Tab = Drain

Features

- International Standard Packages
- Rugged PolarP™ Process
- Avalanche Rated
- Fast Intrinsic Diode
- Low Package Inductance

Advantages

- Easy to Mount
- Space Savings
- High Power Density

Applications

- High-Side Switches
- Push Pull Amplifiers
- DC Choppers
- Automatic Test Equipment
- Current Regulators

Symbol	Test Conditions ($T_J = 25^\circ C$, Unless Otherwise Specified)	Characteristic Values		
		Min.	Typ.	Max.
BV_{DSS}	$V_{GS} = 0V$, $I_D = -250\mu A$	- 200		V
$V_{GS(th)}$	$V_{DS} = V_{GS}$, $I_D = -1mA$	- 2.0		- 4.0 V
I_{GSS}	$V_{GS} = \pm 20V$, $V_{DS} = 0V$			± 100 nA
I_{DSS}	$V_{DS} = V_{DSS}$, $V_{GS} = 0V$ $T_J = 125^\circ C$			- 50 μA - 250 μA
$R_{DS(on)}$	$V_{GS} = -10V$, $I_D = 0.5 \cdot I_{D25}$, Note 1			44 m Ω

Symbol	Test Conditions ($T_J = 25^\circ\text{C}$, Unless Otherwise Specified)	Characteristic Values		
		Min.	Typ.	Max.
g_{fs}	$V_{DS} = -10\text{V}$, $I_D = 0.5 \cdot I_{D25}$, Note 1	30	51	S
C_{iss}	$V_{GS} = 0\text{V}$, $V_{DS} = -25\text{V}$, $f = 1\text{MHz}$		12	nF
C_{oss}			2210	pF
C_{rss}			250	pF
$t_{d(on)}$	Resistive Switching Times $V_{GS} = -10\text{V}$, $V_{DS} = 0.5 \cdot V_{DSS}$, $I_D = 0.5 \cdot I_{D25}$ $R_G = 1\Omega$ (External)		32	ns
t_r			60	ns
$t_{d(off)}$			89	ns
t_f			28	ns
$Q_{g(on)}$	$V_{GS} = -10\text{V}$, $V_{DS} = 0.5 \cdot V_{DSS}$, $I_D = 0.5 \cdot I_{D25}$		205	nC
Q_{gs}			45	nC
Q_{gd}			80	nC
R_{thJC}				0.14 $^\circ\text{C/W}$
R_{thCS}		0.15		$^\circ\text{C/W}$

Source-Drain Diode

Symbol	Test Conditions ($T_J = 25^\circ\text{C}$, Unless Otherwise Specified)	Characteristic Values		
		Min.	Typ.	Max.
I_S	$V_{GS} = 0\text{V}$			- 90 A
I_{SM}	Repetitive, Pulse Width Limited by T_{JM}			- 360 A
V_{SD}	$I_F = -45\text{A}$, $V_{GS} = 0\text{V}$, Note 1			- 3.2 V
t_{rr}	$I_F = -45\text{A}$, $-di/dt = -150\text{A}/\mu\text{s}$ $V_R = -100\text{V}$, $V_{GS} = 0\text{V}$		315	ns
Q_{RM}			6.6	μC
I_{RM}			- 42	A

Note 1: Pulse test, $t \leq 300\mu\text{s}$, duty cycle, $d \leq 2\%$.

TO-264 AA Outline

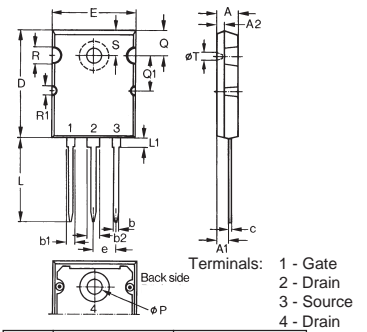

Dim.	Millimeter		Inches	
	Min.	Max.	Min.	Max.
A	4.82	5.13	.190	.202
A1	2.54	2.89	.100	.114
A2	2.00	2.10	.079	.083
b	1.12	1.42	.044	.056
b1	2.39	2.69	.094	.106
b2	2.90	3.09	.114	.122
c	0.53	0.83	.021	.033
D	25.91	26.16	1.020	1.030
E	19.81	19.96	.780	.786
e	5.46 BSC		.215 BSC	
J	0.00	0.25	.000	.010
K	0.00	0.25	.000	.010
L	20.32	20.83	.800	.820
L1	2.29	2.59	.090	.102
P	3.17	3.66	.125	.144
Q	6.07	6.27	.239	.247
Q1	8.38	8.69	.330	.342
R	3.81	4.32	.150	.170
R1	1.78	2.29	.070	.090
S	6.04	6.30	.238	.248
T	1.57	1.83	.062	.072

PLUS 247™ Outline

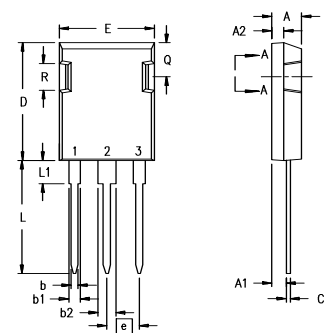

Terminals: 1 - Gate
2 - Drain
3 - Source

Dim.	Millimeter		Inches	
	Min.	Max.	Min.	Max.
A	4.83	5.21	.190	.205
A1	2.29	2.54	.090	.100
A2	1.91	2.16	.075	.085
b	1.14	1.40	.045	.055
b1	1.91	2.13	.075	.084
b2	2.92	3.12	.115	.123
C	0.61	0.80	.024	.031
D	20.80	21.34	.819	.840
E	15.75	16.13	.620	.635
e	5.45 BSC		.215 BSC	
L	19.81	20.32	.780	.800
L1	3.81	4.32	.150	.170
Q	5.59	6.20	.220	0.244
R	4.32	4.83	.170	.190

IXYS Reserves the Right to Change Limits, Test Conditions, and Dimensions.

IXYS MOSFETs and IGBTs are covered by one or more of the following U.S. patents:

4,835,592	4,931,844	5,049,961	5,237,481	6,162,665	6,404,065 B1	6,683,344	6,727,585	7,005,734 B2	7,157,338B2
4,860,072	5,017,508	5,063,307	5,381,025	6,259,123 B1	6,534,343	6,710,405 B2	6,759,692	7,063,975 B2	
4,881,106	5,034,796	5,187,117	5,486,715	6,306,728 B1	6,583,505	6,710,463	6,771,478 B2	7,071,537	

Fig. 1. Output Characteristics @ $T_J = 25^\circ\text{C}$

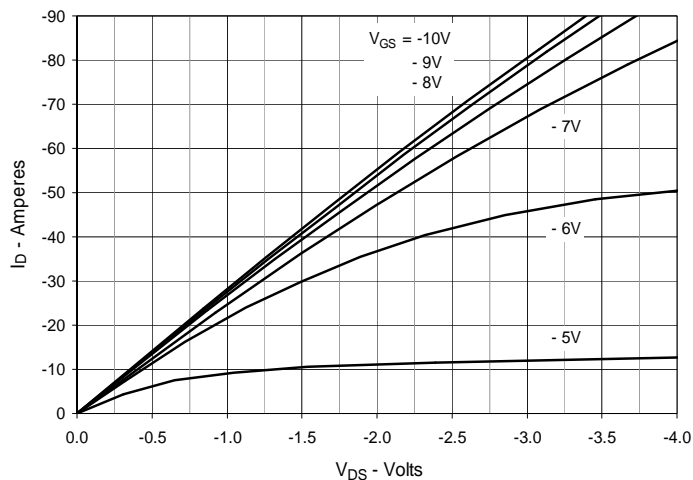

Fig. 2. Extended Output Characteristics @ $T_J = 25^\circ\text{C}$

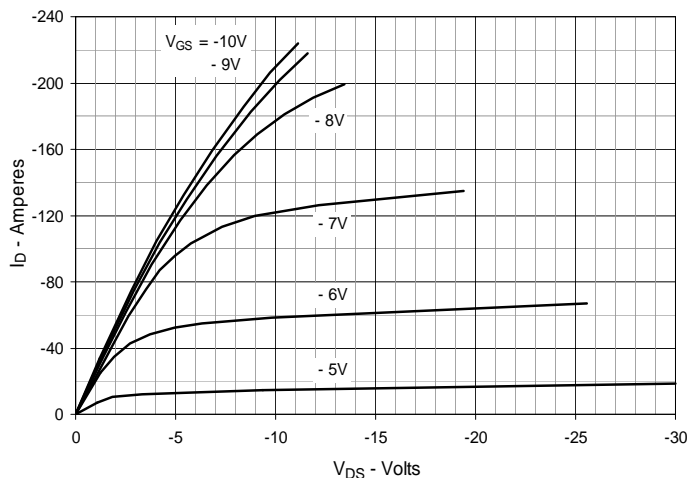

Fig. 3. Output Characteristics @ $T_J = 125^\circ\text{C}$

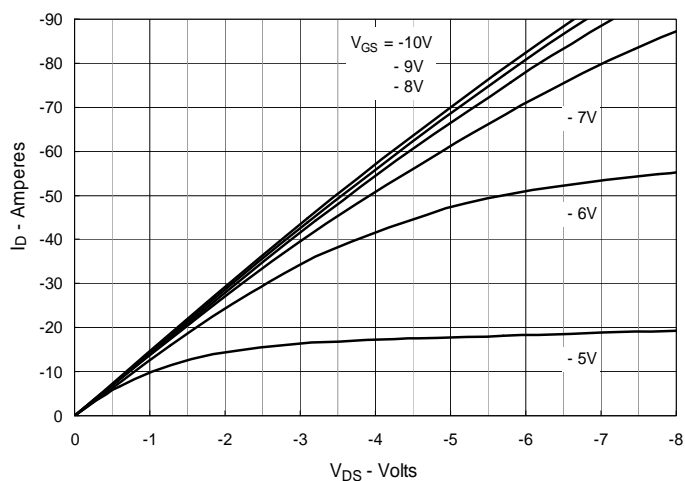

Fig. 4. $R_{DS(on)}$ Normalized to $I_D = -45\text{A}$ Value vs. Junction Temperature

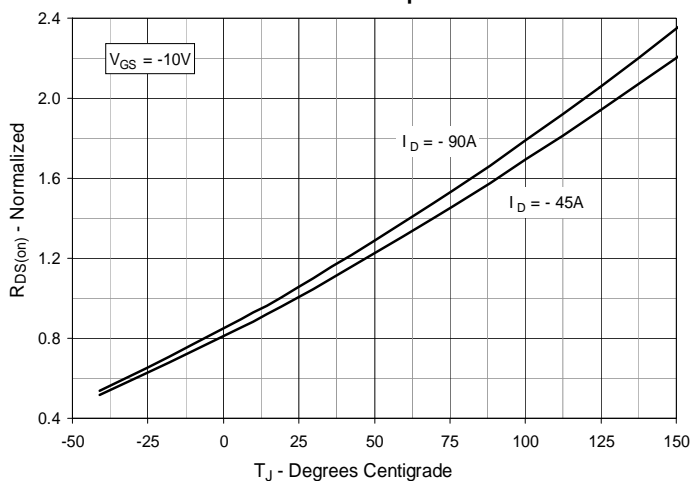

Fig. 5. $R_{DS(on)}$ Normalized to $I_D = -45\text{A}$ Value vs. Drain Current

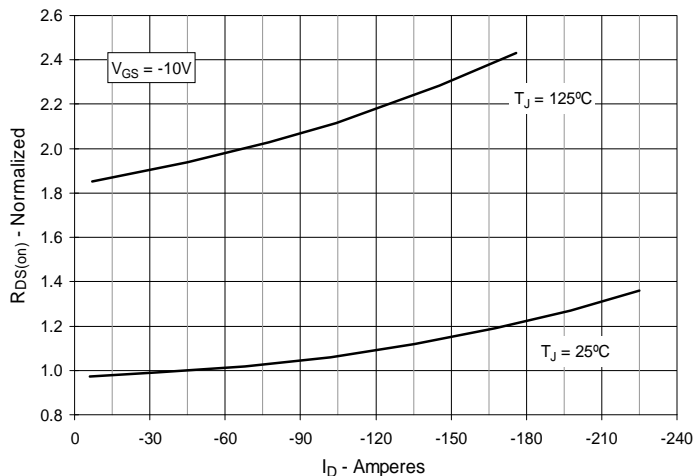

Fig. 6. Maximum Drain Current vs. Case Temperature

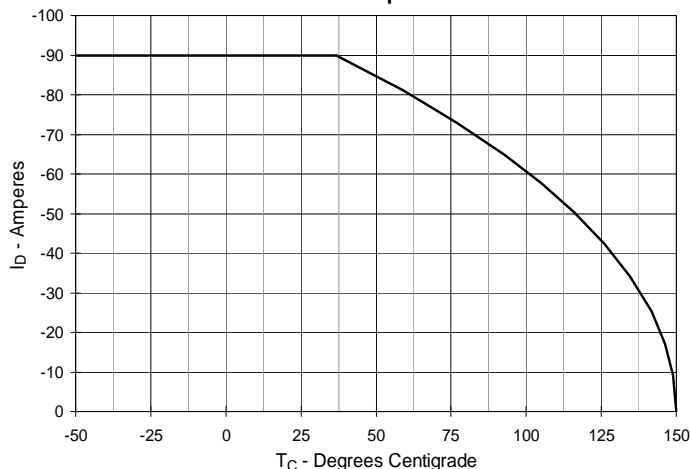

Fig. 7. Input Admittance

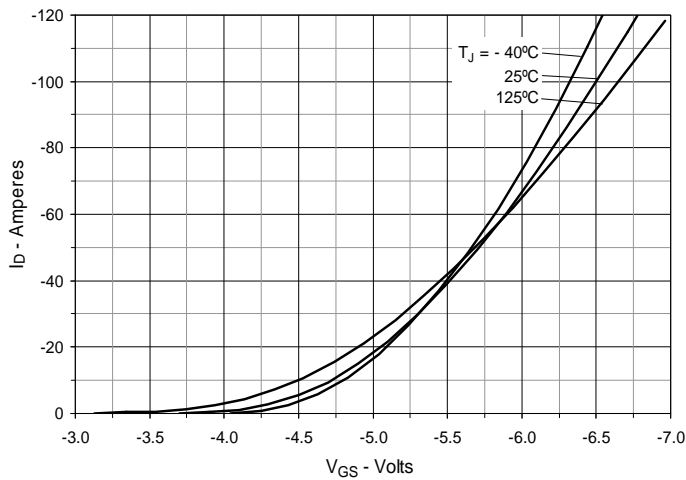

Fig. 8. Transconductance

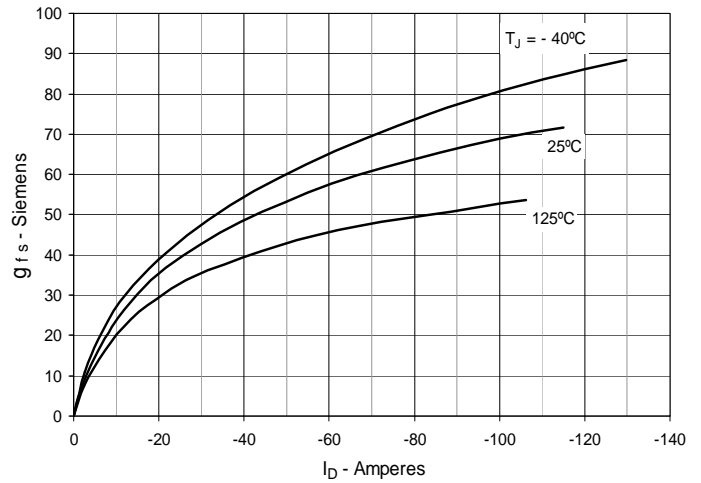

Fig. 9. Forward Voltage Drop of Intrinsic Diode

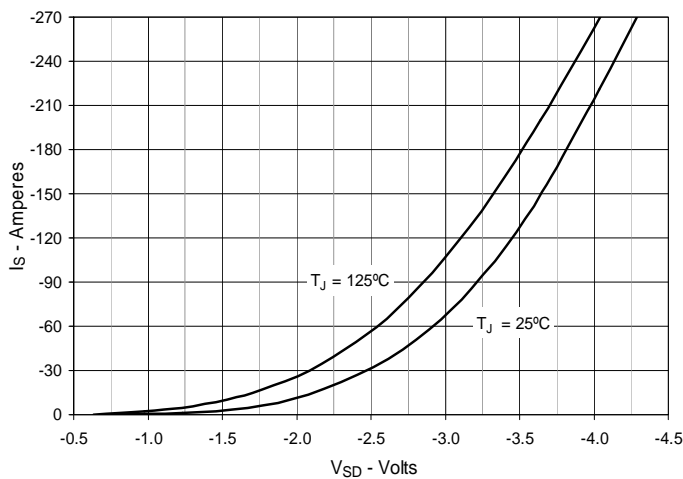

Fig. 10. Gate Charge

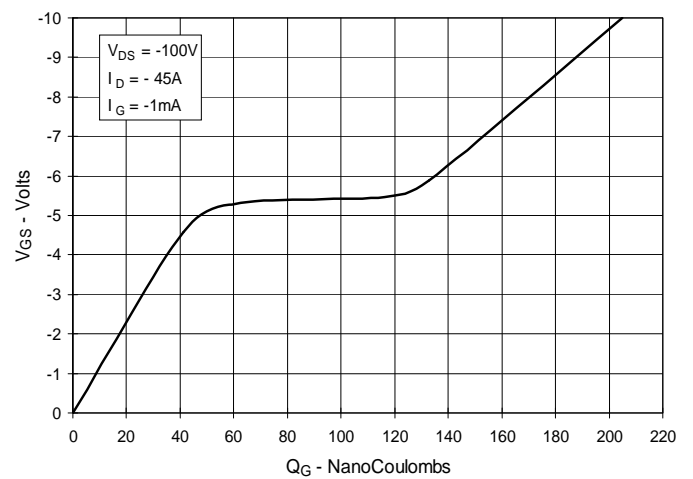

Fig. 11. Capacitance

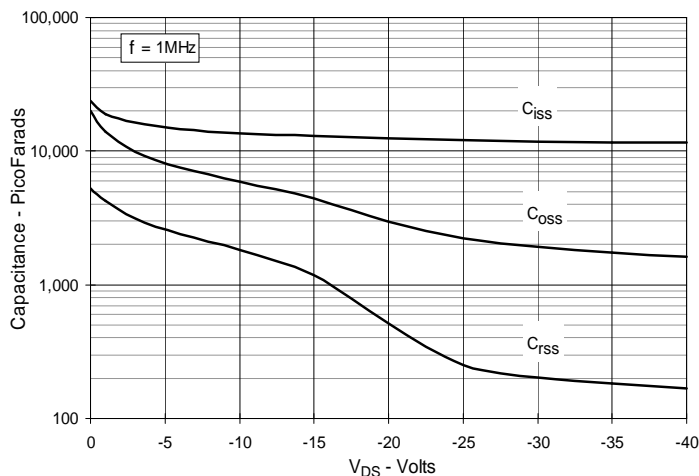

Fig. 12. Forward-Bias Safe Operating Area

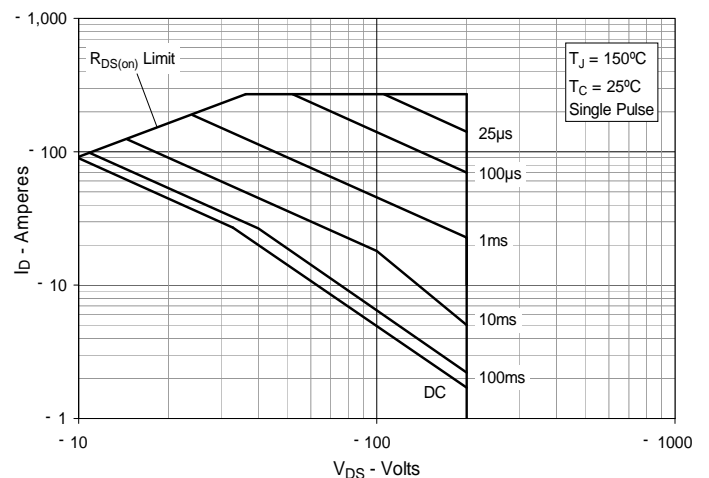
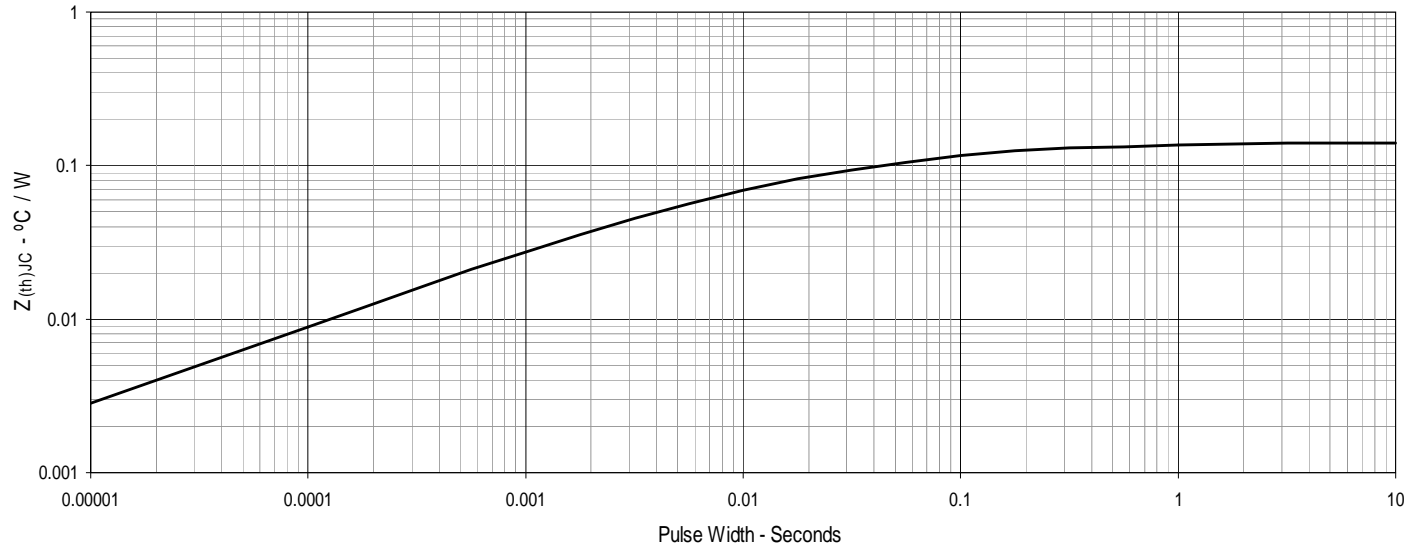

Fig. 13. Maximum Transient Thermal Impedance



Mouser Electronics

Authorized Distributor

Click to View Pricing, Inventory, Delivery & Lifecycle Information:

[IXYS:](#)

[IXTK90P20P](#)