

Six-Pack XPT IGBT

$V_{CES} = 1200\text{ V}$
 $I_{C25} = 60\text{ A}$
 $V_{CE(sat)} = 1.8\text{ V}$

Part name (Marking on product)

MIXA40W1200TML

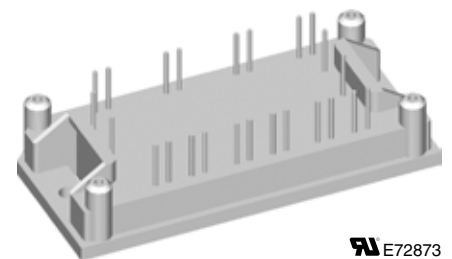
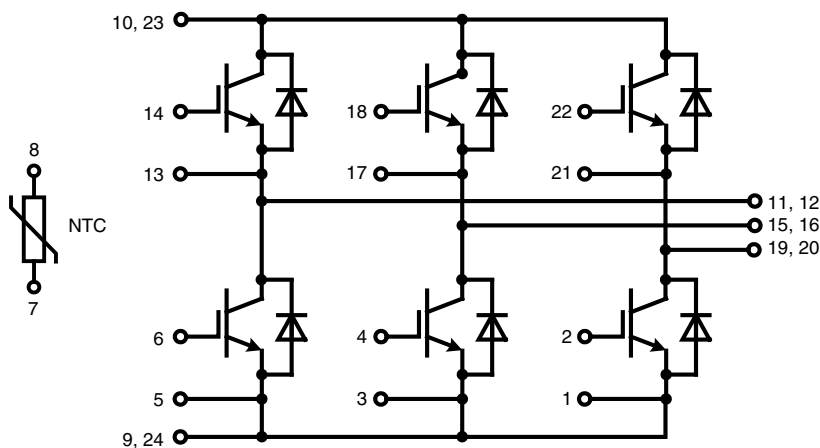

E72873

Pin configuration see outlines.

Features:

- High level of integration
- Rugged XPT design (Xtreme light Punch Through) results in:
 - short circuit rated for 10 μsec .
 - very low gate charge
 - square RBSOA @ 3x I_C
 - low EMI
- Thin wafer technology combined with the XPT design results in a competitive low $V_{CE(sat)}$
- Temperature sense included
- SONIC™ diode
 - fast and soft reverse recovery
 - low operating forward voltage

Application:

- AC motor drives
- Pumps, Fans
- Washing machines
- Air-conditioning system
- Inverter and power supplies

Package:

- E1 package
- Assembly height is 17.1 mm
- Insulated base plate
- Pins suitable for wave soldering and PCB mounting
- UL registered E72873

IGBT T1 - T6

Symbol	Definitions	Conditions	Ratings			Unit	
			min.	typ.	max.		
V_{CES}	collector emitter voltage		$T_{VJ} = 25^{\circ}\text{C}$		1200	V	
V_{GES}	max. DC gate voltage	continuous			± 20	V	
V_{GEM}	max. transient collector gate voltage	transient			± 30	V	
I_{C25}	collector current		$T_C = 25^{\circ}\text{C}$		60	A	
I_{C80}			$T_C = 80^{\circ}\text{C}$		40	A	
P_{tot}	total power dissipation		$T_C = 25^{\circ}\text{C}$		195	W	
$V_{CE(sat)}$	collector emitter saturation voltage	$I_C = 35\text{ A}; V_{GE} = 15\text{ V}$	$T_{VJ} = 25^{\circ}\text{C}$ $T_{VJ} = 125^{\circ}\text{C}$	1.8 2.1	2.1	V V	
$V_{GE(th)}$	gate emitter threshold voltage	$I_C = 1.5\text{ mA}; V_{GE} = V_{CE}$	$T_{VJ} = 25^{\circ}\text{C}$	5.4	5.9	6.5	V
I_{CES}	collector emitter leakage current	$V_{CE} = V_{CES}; V_{GE} = 0\text{ V}$	$T_{VJ} = 25^{\circ}\text{C}$ $T_{VJ} = 125^{\circ}\text{C}$	0.02 0.3	0.15	mA mA	
I_{GES}	gate emitter leakage current	$V_{GE} = \pm 20\text{ V}$			500	nA	
$Q_{G(on)}$	total gate charge	$V_{CE} = 600\text{ V}; V_{GE} = 15\text{ V}; I_C = 35\text{ A}$			106	nC	
$t_{d(on)}$	turn-on delay time	inductive load $V_{CE} = 600\text{ V}; I_C = 35\text{ A}$ $V_{GE} = \pm 15\text{ V}; R_G = 27\ \Omega$	$T_{VJ} = 125^{\circ}\text{C}$		70	ns	
t_r	current rise time				40	ns	
$t_{d(off)}$	turn-off delay time				250	ns	
t_f	current fall time				100	ns	
E_{on}	turn-on energy per pulse				3.8	mJ	
E_{off}	turn-off energy per pulse				4.1	mJ	
RBSOA	reverse bias safe operating area	$V_{GE} = \pm 15\text{ V}; R_G = 27\ \Omega; V_{CEK} = 1200\text{ V}$	$T_{VJ} = 125^{\circ}\text{C}$		105	A	
I_{SC} (SCSOA)	short circuit safe operating area	$V_{CE} = 900\text{ V}; V_{GE} = \pm 15\text{ V};$ $R_G = 27\ \Omega; t_p = 10\ \mu\text{s};$ non-repetitive	$T_{VJ} = 125^{\circ}\text{C}$		140	A	
R_{thJC}	thermal resistance junction to case	(per IGBT)			0.21	K/W	
R_{thCH}	thermal resistance case to heatsink				0.64	K/W	

Diode D1 - D6

Symbol	Definitions	Conditions	Ratings			Unit
			min.	typ.	max.	
V_{RRM}	max. repetitive reverse voltage		$T_{VJ} = 25^{\circ}\text{C}$		1200	V
I_{F25}	forward current		$T_C = 25^{\circ}\text{C}$		44	A
I_{F80}			$T_C = 80^{\circ}\text{C}$		29	A
V_F	forward voltage	$I_F = 30\text{ A}; V_{GE} = 0\text{ V}$	$T_{VJ} = 25^{\circ}\text{C}$ $T_{VJ} = 125^{\circ}\text{C}$	1.95 1.95	2.2	V V
Q_{rr}	reverse recovery charge	$V_R = 600\text{ V}$ $di_F/dt = -600\text{ A}/\mu\text{s}$ $I_F = 30\text{ A}; V_{GE} = 0\text{ V}$	$T_{VJ} = 125^{\circ}\text{C}$		3.5	μC
I_{RM}	max. reverse recovery current				30	A
t_{rr}	reverse recovery time				350	ns
E_{rec}	reverse recovery energy				0.9	mJ
R_{thJC}	thermal resistance junction to case	(per diode)			0.4	K/W
R_{thCH}	thermal resistance case to heatsink				1.2	K/W

Temperature Sensor NTC

Symbol	Definitions	Conditions	Ratings			Unit
			min.	typ.	max.	
R_{25}	resistance	$T_C = 25^\circ\text{C}$	4.75	5.0	5.25	k Ω
$B_{25/50}$				3375		K

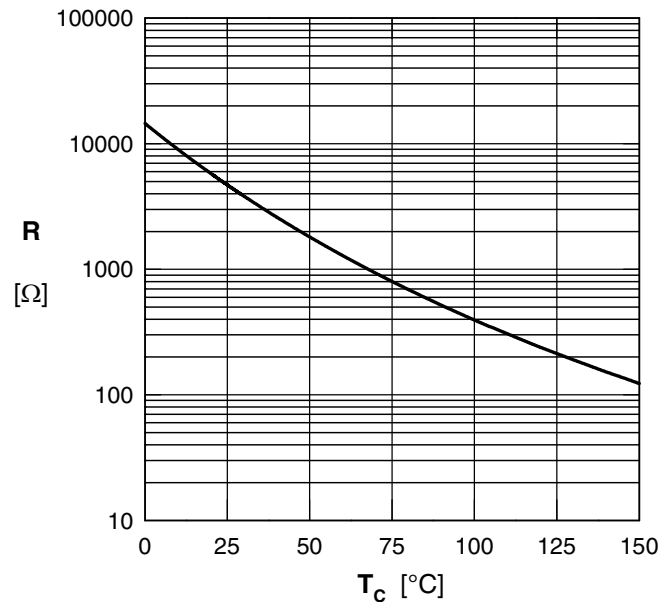

Typ. NTC resistance vs. temperature

Module

Symbol	Definitions	Conditions	Ratings			Unit
			min.	typ.	max.	
T_{VJ}	operating temperature		-40		125	$^\circ\text{C}$
T_{VJM}	max. virtual junction temperature				150	$^\circ\text{C}$
T_{stg}	storage temperature		-40		125	$^\circ\text{C}$
V_{ISOL}	isolation voltage	$I_{ISOL} \leq 1 \text{ mA}; 50/60 \text{ Hz}$			2500	V~
CTI	comparative tracking index				-	
F_C	mounting force		40		80	N
d_s	creep distance on surface		12.7			mm
d_A	strike distance through air		12.7			mm
Weight				40		g

Circuit Diagram

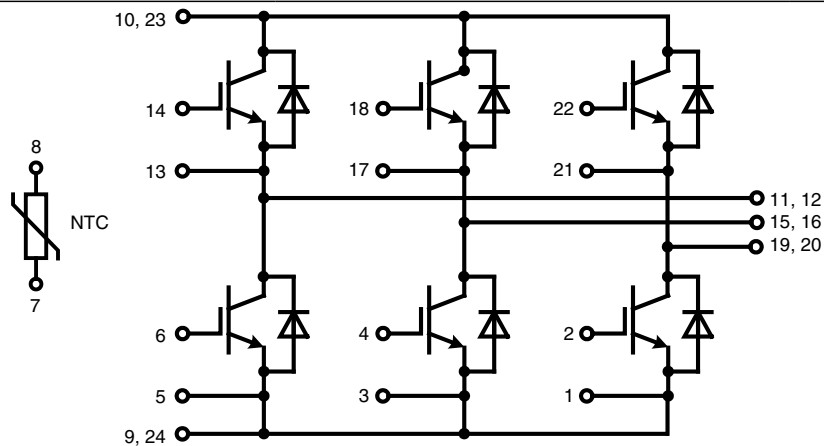

Outline Drawing

Dimensions in mm (1 mm = 0.0394")

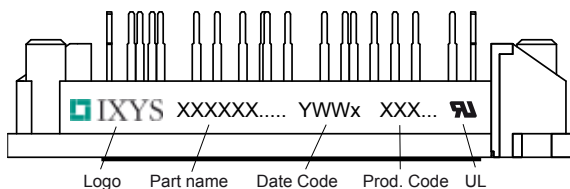
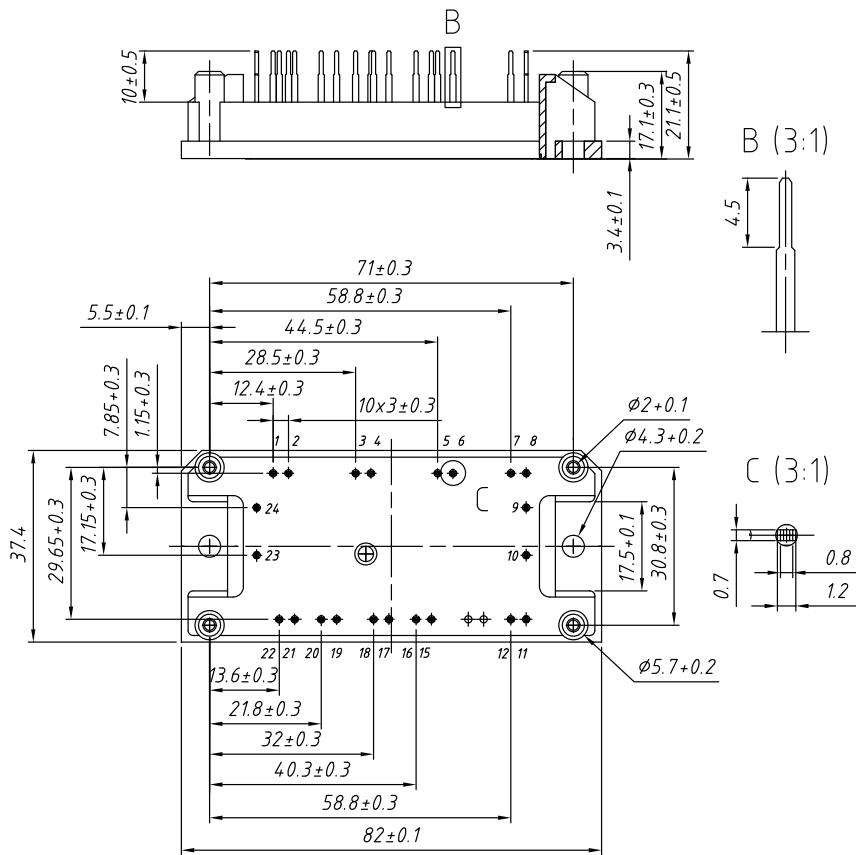

Part number

- M = Module
- I = IGBT
- X = XPT
- A = standard
- 40 = Current Rating [A]
- W = 6-Pack
- 1200 = Reverse Voltage [V]
- T = NTC
- ML = E1-Pack

Ordering	Part Name	Marking on Product	Delivering Mode	Base Qty	Ordering Code
Standard	MIXA 40 W 1200 TML	MIXA40W1200TML	Box	10	510628

IGBT T1 - T6

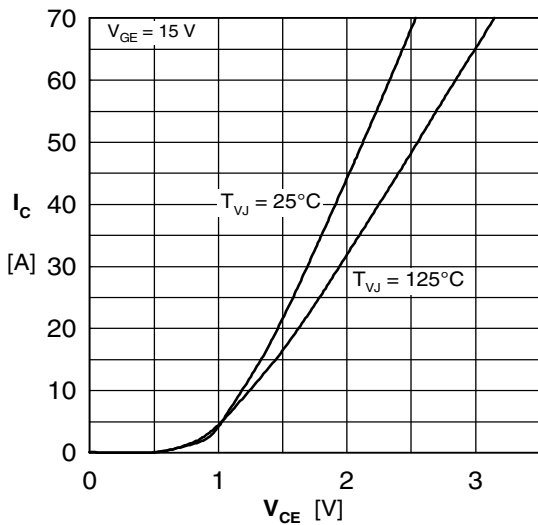

Fig. 1 Typ. output characteristics

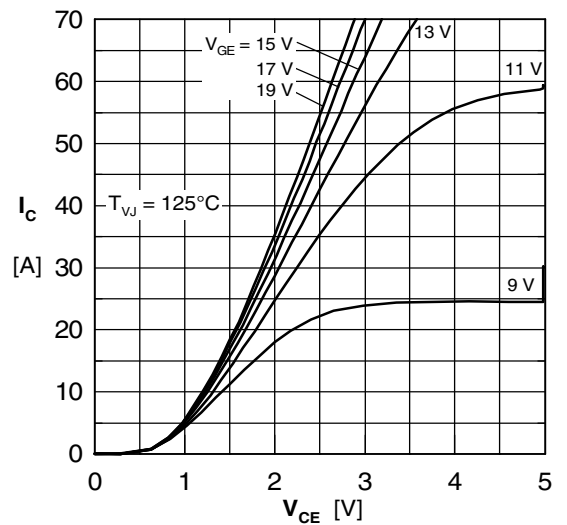

Fig. 2 Typ. output characteristics

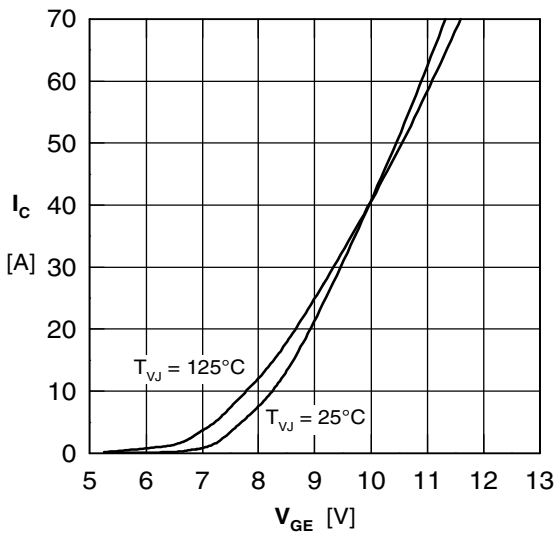

Fig. 3 Typ. transfer characteristics

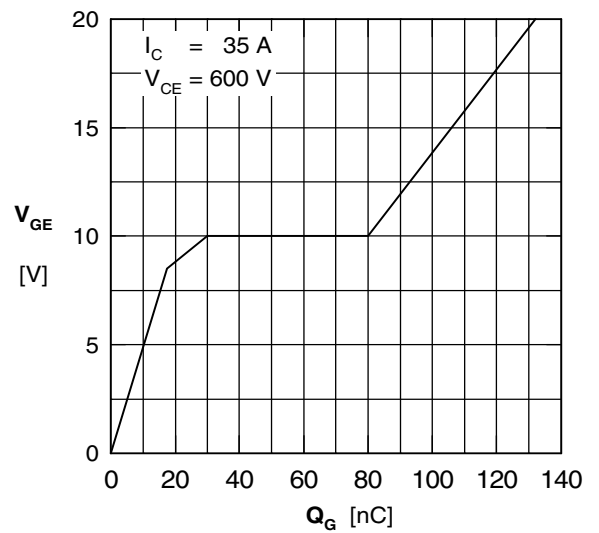

Fig. 4 Typ. turn-on gate charge

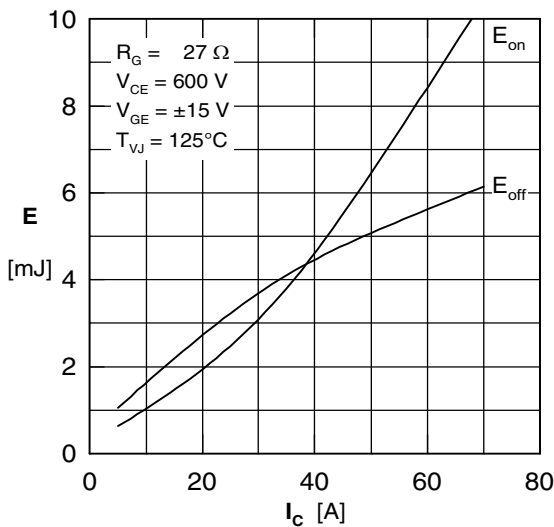

Fig. 5 Typ. switching energy vs. collector current

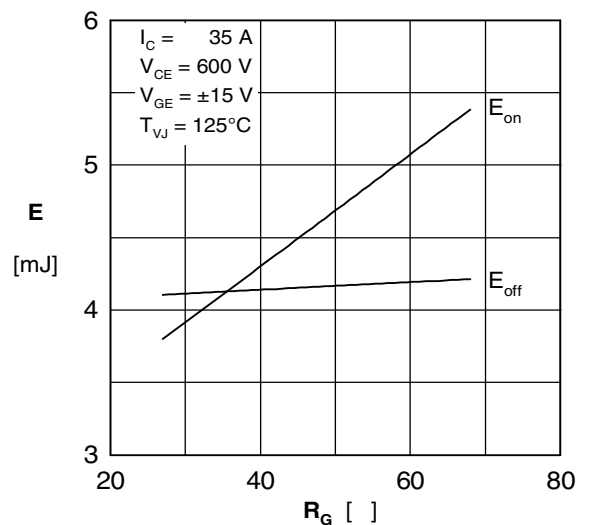

Fig. 6 Typ. switching energy vs. gate resistance

Diode D1 - D6

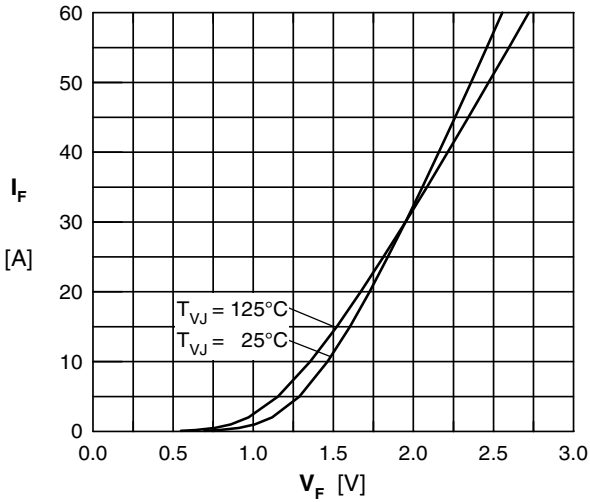

Fig. 7 Typ. Forward current versus V_F

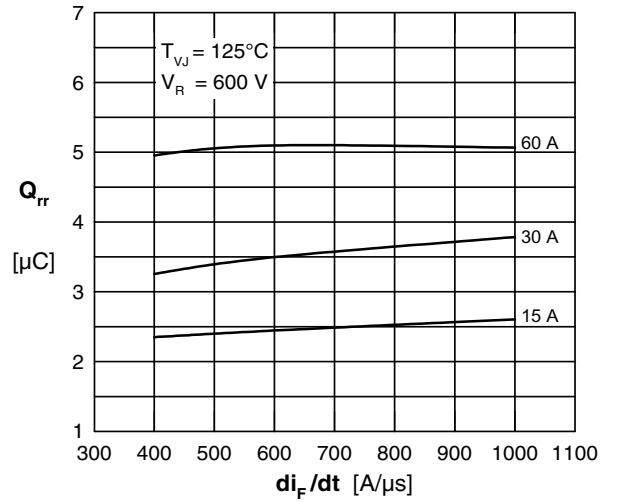

Fig. 8 Typ. reverse recov.charge Q_{rr} vs. di/dt

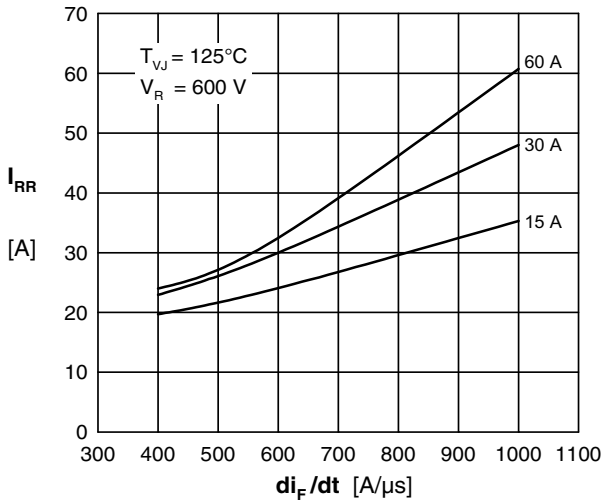

Fig. 9 Typ. peak reverse current I_{RM} vs. di/dt

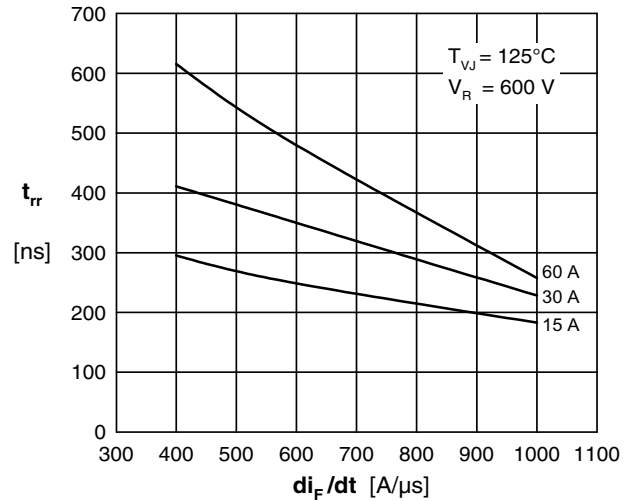

Fig. 10 Typ. recovery time t_{rr} versus di/dt

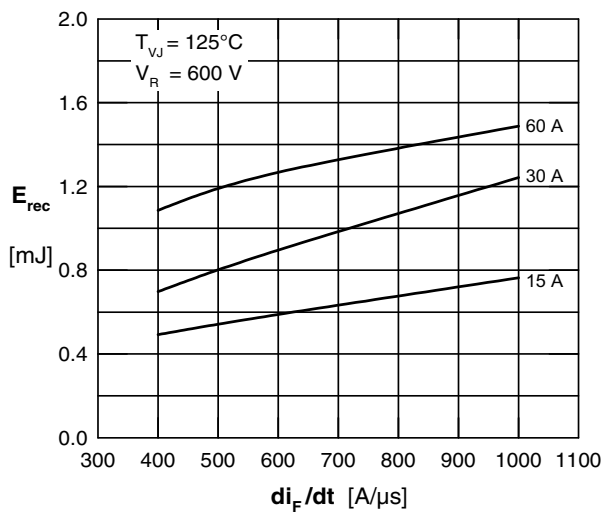

Fig. 11 Typ. recovery energy E_{rec} versus di/dt

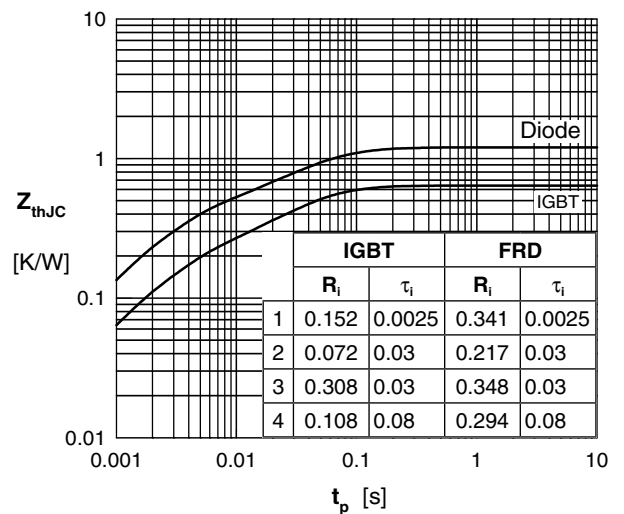

Fig. 12 Typ. transient thermal impedance

Mouser Electronics

Authorized Distributor

Click to View Pricing, Inventory, Delivery & Lifecycle Information:

[IXYS:](#)

[MIXA40W1200TML](#)