

# MAX17541G

# 42V, 500mA, Ultra-Small, High-Efficiency, Synchronous Step-Down DC-DC Converter

## General Description

The MAX17541G high-efficiency, high-voltage, synchronous step-down DC-DC converter with integrated MOSFETs operates over 4.5V to 42V input. The converter can deliver up to 500mA and generates output voltages from 0.9V up to  $0.92 \times V_{IN}$ . The feedback (FB) voltage is accurate to within  $\pm 1.7\%$  over  $-40^\circ\text{C}$  to  $+125^\circ\text{C}$ .

The MAX17541G uses peak-current-mode control with pulse-width modulation (PWM) and operates with fixed 600kHz switching frequency at any load. The device is available in a 10-pin (3mm x 2mm) TDFN package. Simulation models are available.

## Applications

- Industrial Process Control
- HVAC and Building Control
- Base Station, VOIP, Telecom
- Home Theatre
- Battery-Powered Equipment
- General-Purpose Point of Load

## Benefits and Features

- Reduces External Components and Total Cost
  - No Schottky-Synchronous Operation
  - All-Ceramic Capacitors, Ultra-Compact Layout
- Reduces Number of DC-DC Regulators to Stock
  - Wide 4.5V to 42V Input
  - Adjustable 0.9V to  $92\%V_{IN}$  Output
  - Delivers up to 500mA
- Reduces Power Dissipation
  - Peak Efficiency > 90%
  - Shutdown Current =  $0.9\mu\text{A}$  (typ)
- Operates Reliably in Adverse Industrial Environments
  - Hiccup-Mode Current Limit, Sink Current Limit, and Autoretry Startup
  - Built-In Output-Voltage Monitoring ( $\overline{\text{RESET}}$  Pin)
  - Programmable EN/UVLO Threshold
  - Adjustable Soft-Start and Prebiased Power-Up
  - High Industrial  $-40^\circ\text{C}$  to  $+125^\circ\text{C}$  Ambient Operating Temperature Range/ $-40^\circ\text{C}$  to  $+150^\circ\text{C}$  Junction Temperature Range

*Ordering Information appears at end of data sheet.*

## MAX17541G Application Circuit (5V Output, 500mA Maximum Load Current)

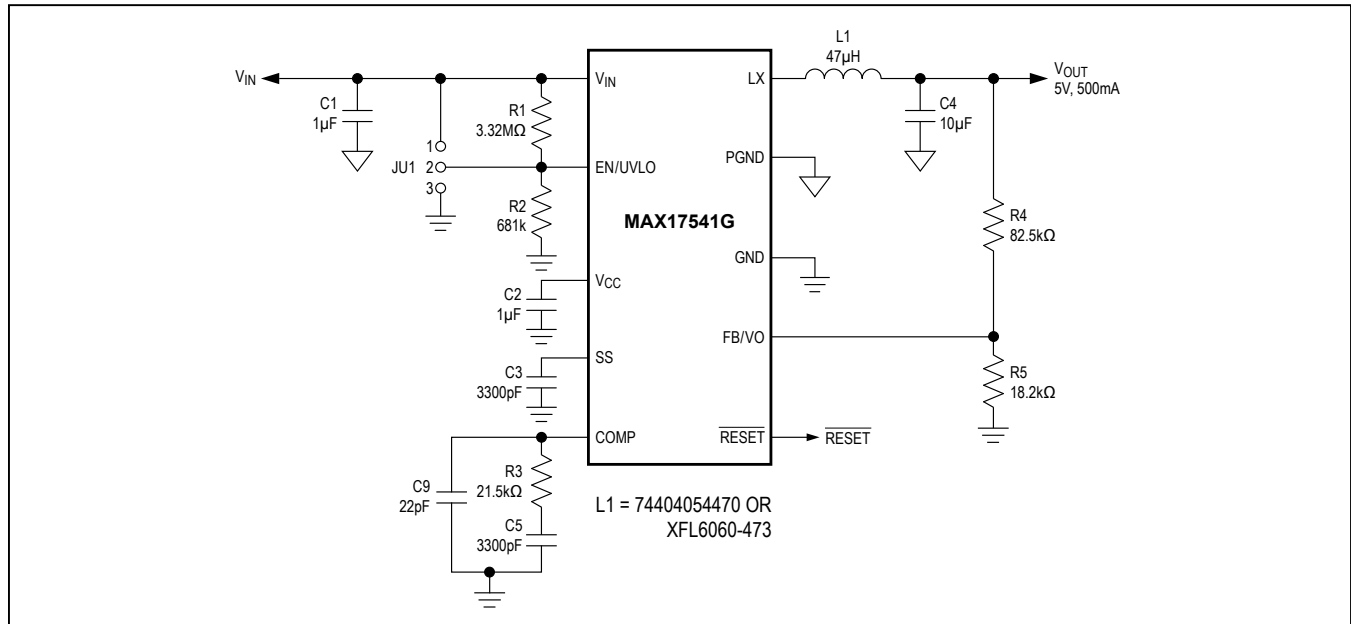

**Absolute Maximum Ratings**

V <sub>IN</sub> to GND.....	-0.3V to +48V	Output Short-Circuit Duration.....	Continuous
EN/UVLO to GND.....	-0.3V to (V <sub>IN</sub> + 0.3V)	Junction Temperature.....	+150°C
LX to PGND.....	-0.3V to (V <sub>IN</sub> + 0.3V)	Storage Temperature Range.....	-65°C to +160°C
FB, RESET, COMP, SS to GND .....	-0.3V to +6V	Lead Temperature (soldering, 10s).....	+300°C
V <sub>CC</sub> to GND.....	-0.3V to +6V	Soldering Temperature (reflow).....	+260°C
GND to PGND.....	-0.3V to +0.3V		
LX Total RMS Current.....	±1.6A		

Stresses beyond those listed under "Absolute Maximum Ratings" may cause permanent damage to the device. These are stress ratings only, and functional operation of the device at these or any other conditions beyond those indicated in the operational sections of the specifications is not implied. Exposure to absolute maximum rating conditions for extended periods may affect device reliability. Junction temperature greater than +125°C degrades operating lifetimes.

**Package Thermal Characteristics (Note 1)**

10 TDFN	
Continuous Power Dissipation (T <sub>A</sub> = +70°C) (derate 14.9mW/°C above +70°C) (multilayer board).	1188.7mW
Junction-to-Ambient Thermal Resistance (θ <sub>JA</sub> ) .....	67.3°C/W
Junction-to-Case Thermal Resistance (θ <sub>JC</sub> ).....	18.2°C/W

**Note 1:** Package thermal resistances were obtained using the method described in JEDEC specification JESD51-7, using a four-layer board. For detailed information on package thermal considerations, refer to [www.maximintegrated.com/thermal-tutorial](http://www.maximintegrated.com/thermal-tutorial).

**Electrical Characteristics**

(V<sub>IN</sub> = 24V, V<sub>GND</sub> = V<sub>PGND</sub> = 0V, C<sub>VIN</sub> = 1µF, C<sub>VCC</sub> = 1µF, V<sub>EN</sub> = 1.5V, C<sub>SS</sub> = 3300pF, V<sub>FB</sub> = 0.98 x V<sub>OUT</sub>, LX = unconnected, RESET = unconnected. T<sub>A</sub> = -40°C to +125°C, unless otherwise noted. Typical values are at T<sub>A</sub> = +25°C. All voltages are referenced to GND, unless otherwise noted.) (Note 2)

PARAMETER	SYMBOL	CONDITIONS	MIN	TYP	MAX	UNITS
<b>INPUT SUPPLY (V<sub>IN</sub>)</b>						
Input Voltage Range	V <sub>IN</sub>		4.5		42	V
Input Supply Current	I <sub>IN-SH</sub>	V <sub>EN</sub> = 0V, shutdown mode		0.9	3.5	µA
	I <sub>IN-SW</sub>	Normal switching mode, no load		4.75	6.75	mA
<b>ENABLE/UVLO (EN/UVLO)</b>						
EN Threshold	V <sub>ENR</sub>	V <sub>EN</sub> rising	1.194	1.218	1.236	V
	V <sub>ENF</sub>	V <sub>EN</sub> falling	1.114	1.135	1.156	
	V <sub>EN-TRUESD</sub>	V <sub>EN</sub> falling, true shutdown		0.7		
EN Input Leakage Current	I <sub>EN</sub>	V <sub>EN</sub> = V <sub>IN</sub> = 42V, T <sub>A</sub> = +25°C		8	200	nA
<b>LDO</b>						
V <sub>CC</sub> Output Voltage Range	V <sub>CC</sub>	6V < V <sub>IN</sub> < 12V, 0mA < I <sub>VCC</sub> < 10mA, 12V < V <sub>IN</sub> < 42V, 0mA < I <sub>VCC</sub> < 2mA	4.65	5	5.35	V
V <sub>CC</sub> Current Limit	I <sub>VCC-MAX</sub>	V <sub>CC</sub> = 4.3V, V <sub>IN</sub> = 12V	15	40	80	mA
V <sub>CC</sub> Dropout	V <sub>CC-DO</sub>	V <sub>IN</sub> = 4.5V, I <sub>VCC</sub> = 5mA	4.1			V
V <sub>CC</sub> UVLO	V <sub>CC-UVR</sub>	V <sub>CC</sub> rising	3.85	4	4.15	V
	V <sub>CC-UVF</sub>	V <sub>CC</sub> falling	3.55	3.7	3.85	

# MAX17541G

# 42V, 500mA, Ultra-Small, High-Efficiency, Synchronous Step-Down DC-DC Converter

## Electrical Characteristics (continued)

( $V_{IN} = 24V$ ,  $V_{GND} = V_{PGND} = 0V$ ,  $C_{VIN} = 1\mu F$ ,  $C_{VCC} = 1\mu F$ ,  $V_{EN} = 1.5V$ ,  $C_{SS} = 3300pF$ ,  $V_{FB} = 0.98 \times V_{OUT}$ , LX = unconnected,  $\overline{RESET}$  = unconnected.  $T_A = -40^\circ C$  to  $+125^\circ C$ , unless otherwise noted. Typical values are at  $T_A = +25^\circ C$ . All voltages are referenced to GND, unless otherwise noted.) (Note 2)

PARAMETER	SYMBOL	CONDITIONS	MIN	TYP	MAX	UNITS
<b>POWER MOSFETS</b>						
High-Side pMOS On-Resistance	$R_{DS-ONH}$	$I_{LX} = 0.5A$ (sourcing)	$T_A = +25^\circ C$	0.55	0.85	$\Omega$
			$T_A = T_J = +125^\circ C$ (Note 3)		1.2	
Low-Side nMOS On-Resistance	$R_{DS-ONL}$	$I_{LX} = 0.5A$ (sinking)	$T_A = +25^\circ C$	0.2	0.35	$\Omega$
			$T_A = T_J = +125^\circ C$ (Note 3)		0.47	
LX Leakage Current	$I_{LX\_LKG}$	$V_{EN} = 0V$ , $T_A = +25^\circ C$ , $V_{LX} = (V_{PGND} + 1V)$ to $(V_{IN} - 1V)$			1	$\mu A$
<b>SOFT-START (SS)</b>						
Charging Current	$I_{SS}$	$V_{SS} = 0.5V$	4.7	5	5.3	$\mu A$
<b>FEEDBACK (FB/VO)</b>						
FB Regulation Voltage	$V_{FB\_REG}$		0.884	0.9	0.916	V
FB Input Bias Current	$I_{FB}$	$V_{FB} = 0.9V$			100	nA
<b>OUTPUT VOLTAGE (<math>V_{OUT}</math>)</b>						
Output Voltage Range	$V_{OUT}$		0.9		$0.92 \times V_{IN}$	V
<b>TRANSCONDUCTANCE AMPLIFIER (COMP)</b>						
Transconductance	$G_M$	$I_{COMP} = \pm 2.5\mu A$	510	590	650	$\mu S$
COMP Source Current	$I_{COMP\_SRC}$		19	32	55	$\mu A$
COMP Sink Current	$I_{COMP\_SINK}$		19	32	55	$\mu A$
Current-Sense Transresistance	$R_{CS}$		0.9	1	1.1	V/A
<b>CURRENT LIMIT</b>						
Peak Current-Limit Threshold	$I_{PEAK-LIMIT}$		0.64	0.76	0.86	A
Runaway Current-Limit Threshold	$I_{RUNAWAY-LIMIT}$		0.65	0.78	0.905	A
Sink Current-Limit Threshold	$I_{SINK-LIMIT}$		0.3	0.35	0.4	A
<b>TIMINGS</b>						
Switching Frequency	$f_{SW}$	$V_{FB} > V_{OUT-HICF}$	560	600	640	kHz
		$V_{FB} < V_{OUT-HICF}$	280	300	320	
Events to Hiccup after Crossing Runaway Current Limit				1		Event
$V_{OUT}$ Undervoltage Trip Level to Cause Hiccup	$V_{OUT-HICF}$	$V_{SS} > 0.95V$ (soft-start is done)	69.14	71.14	73.14	%
HICCUP Timeout				32,768		Cycles
Minimum On-Time	$t_{ON\_MIN}$			75	120	ns
Maximum Duty Cycle	$D_{MAX}$	$V_{FB} = 0.98 \times V_{FB-REG}$	92	94	96	%
LX Dead Time				5		ns

**Electrical Characteristics (continued)**

( $V_{IN} = 24V$ ,  $V_{GND} = V_{PGND} = 0V$ ,  $C_{VIN} = 1\mu F$ ,  $C_{VCC} = 1\mu F$ ,  $V_{EN} = 1.5V$ ,  $C_{SS} = 3300pF$ ,  $V_{FB} = 0.98 \times V_{OUT}$ , LX = unconnected,  $\overline{RESET}$  = unconnected.  $T_A = -40^\circ C$  to  $+125^\circ C$ , unless otherwise noted. Typical values are at  $T_A = +25^\circ C$ . All voltages are referenced to GND, unless otherwise noted.) (Note 2)

PARAMETER	SYMBOL	CONDITIONS	MIN	TYP	MAX	UNITS
<b>RESET</b>						
$\overline{RESET}$ Output Level Low		$I_{RESET} = 1mA$			0.02	V
$\overline{RESET}$ Output Leakage Current High		$V_{FB} = 1.01 \times V_{FB-REG}$ , $T_A = +25^\circ C$			0.45	$\mu A$
$V_{OUT}$ Threshold for $\overline{RESET}$ Falling	$V_{OUT-OKF}$	$V_{FB}$ falling	90.5	92.5	94.5	%
$V_{OUT}$ Threshold for $\overline{RESET}$ Rising	$V_{OUT-OKR}$	$V_{FB}$ rising	93.5	95.5	97.5	%
$\overline{RESET}$ Delay After FB Reaches 95% Regulation		$V_{FB}$ rising		1024		Cycles
<b>THERMAL SHUTDOWN</b>						
Thermal-Shutdown Threshold		Temperature rising		165		$^\circ C$
Thermal-Shutdown Hysteresis				10		$^\circ C$

**Note 2:** All limits are 100% tested at  $+25^\circ C$ . Limits over the operating temperature range and relevant supply voltage range are guaranteed by design and characterization.

**Note 3:** Guaranteed by design, not production tested.

Typical Operating Characteristics

( $V_{IN} = 24V$ ,  $V_{GND} = V_{PGND} = 0V$ ,  $C_{VIN} = 1\mu F$ ,  $C_{VCC} = 1\mu F$ ,  $V_{EN} = 1.5V$ ,  $C_{SS} = 3300pF$ ,  $V_{FB} = 0.98 \times V_{OUT}$ ,  $LX =$  unconnected,  $RESET =$  unconnected,  $T_A = -40^\circ C$  to  $+125^\circ C$ , unless otherwise noted. Typical values are at  $T_A = +25^\circ C$ . All voltages are referenced to GND, unless otherwise noted.)

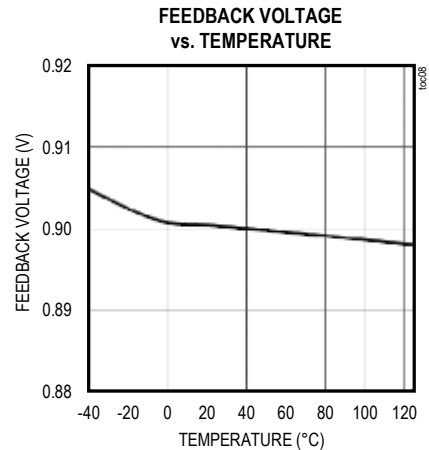
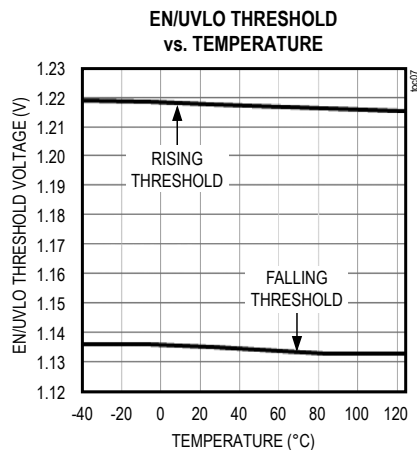
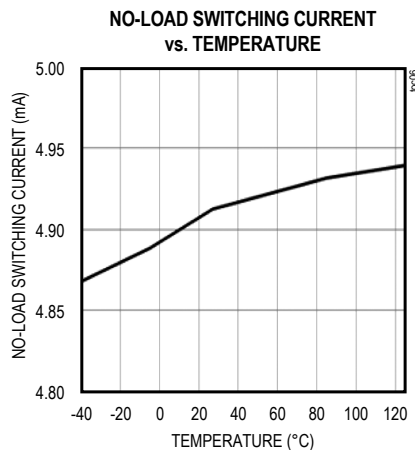
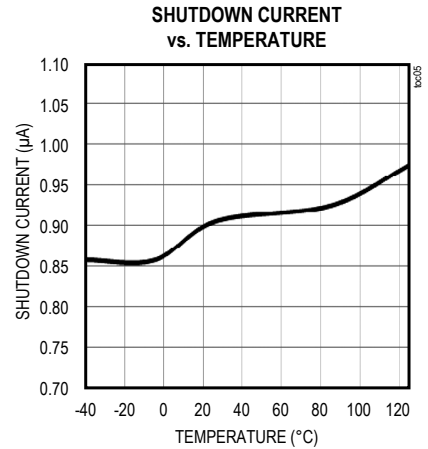
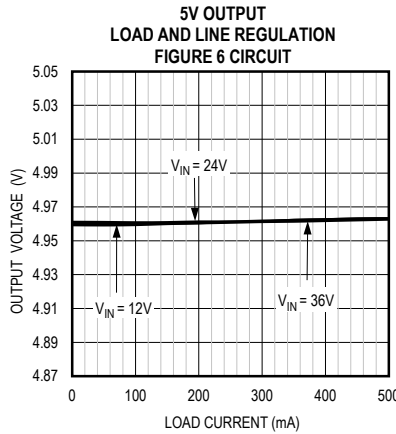
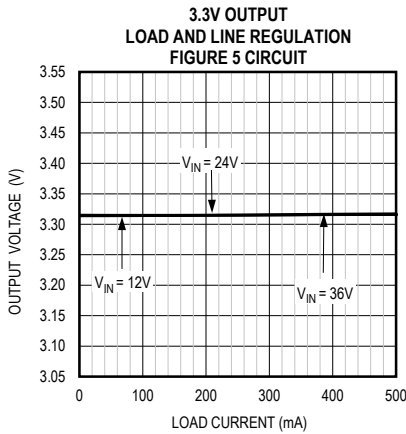
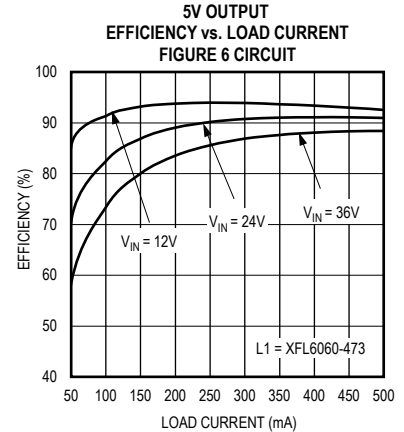
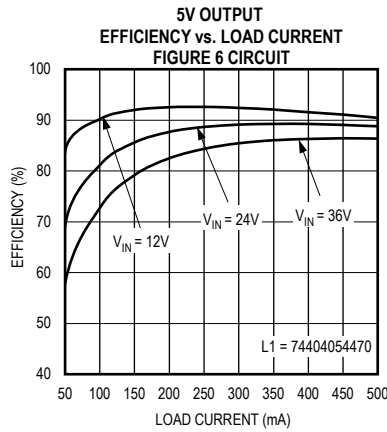
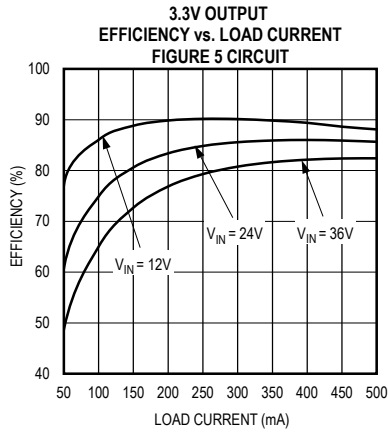

Typical Operating Characteristics (continued)

( $V_{IN} = 24V$ ,  $V_{GND} = V_{PGND} = 0V$ ,  $C_{VIN} = 1\mu F$ ,  $C_{VCC} = 1\mu F$ ,  $V_{EN} = 1.5V$ ,  $C_{SS} = 3300pF$ ,  $V_{FB} = 0.98 \times V_{OUT}$ , LX = unconnected, RESET = unconnected,  $T_A = -40^\circ C$  to  $+125^\circ C$ , unless otherwise noted. Typical values are at  $T_A = +25^\circ C$ . All voltages are referenced to GND, unless otherwise noted.)

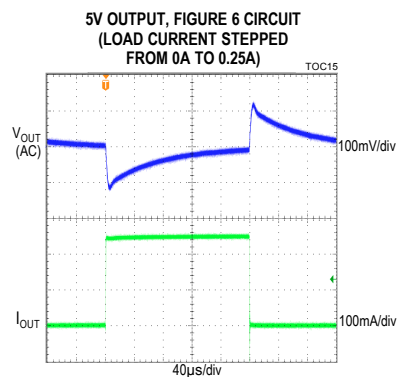
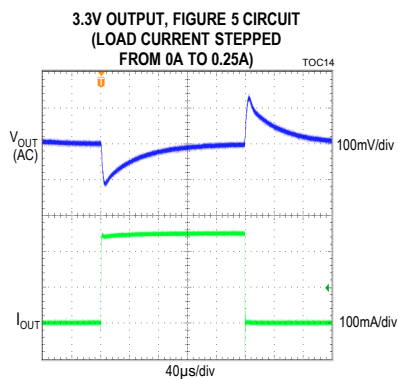
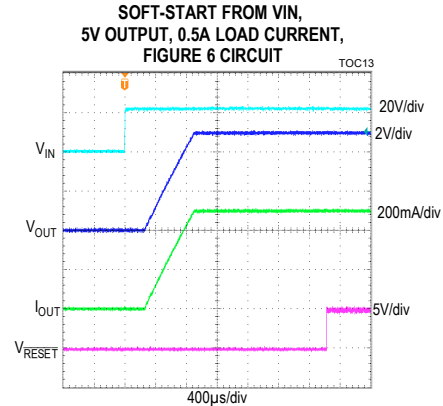
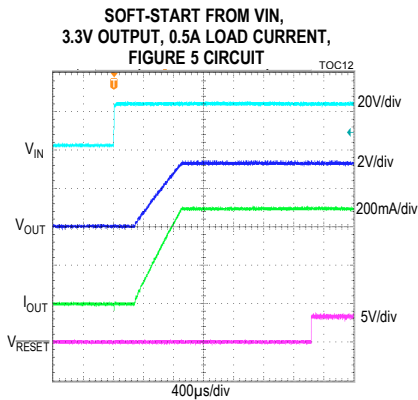
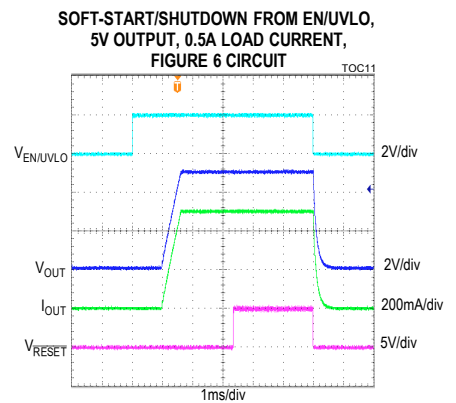
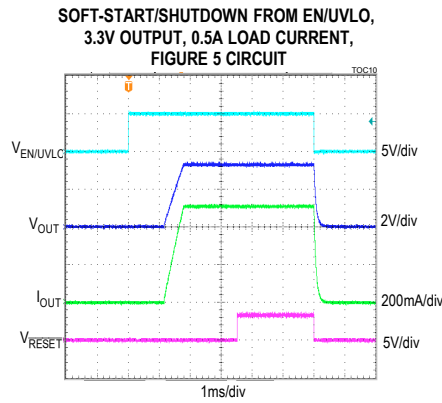
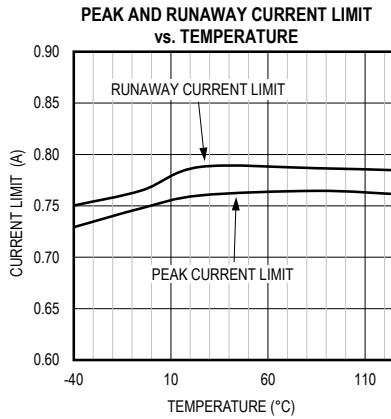

# MAX17541G

# 42V, 500mA, Ultra-Small, High-Efficiency, Synchronous Step-Down DC-DC Converter

## Typical Operating Characteristics (continued)

( $V_{IN} = 24V$ ,  $V_{GND} = V_{PGND} = 0V$ ,  $C_{VIN} = 1\mu F$ ,  $C_{VCC} = 1\mu F$ ,  $V_{EN} = 1.5V$ ,  $C_{SS} = 3300pF$ ,  $V_{FB} = 0.98 \times V_{OUT}$ ,  $L_X =$  unconnected,  $RESET =$  unconnected,  $T_A = -40^\circ C$  to  $+125^\circ C$ , unless otherwise noted. Typical values are at  $T_A = +25^\circ C$ . All voltages are referenced to GND, unless otherwise noted.)

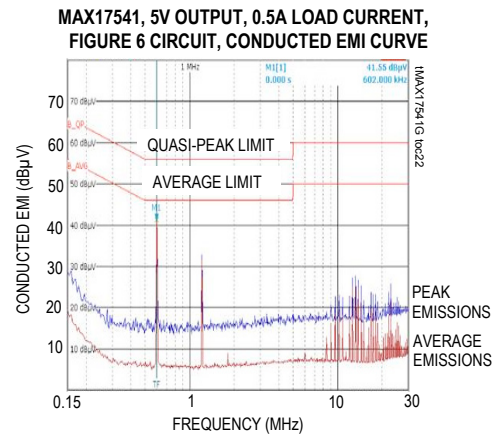
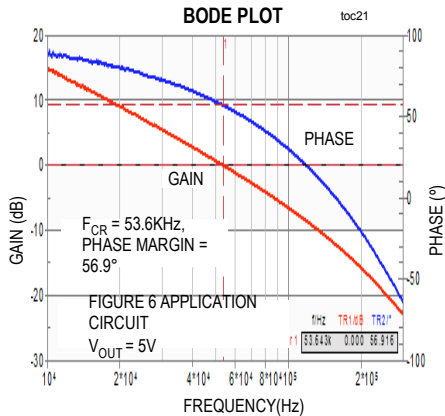
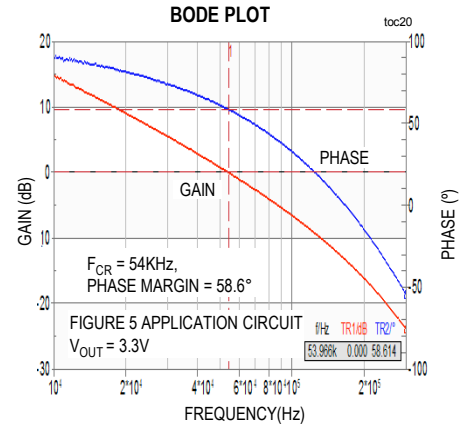
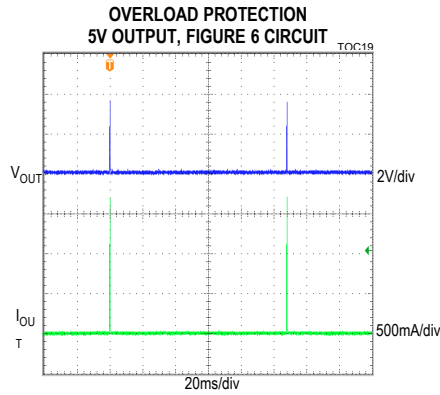
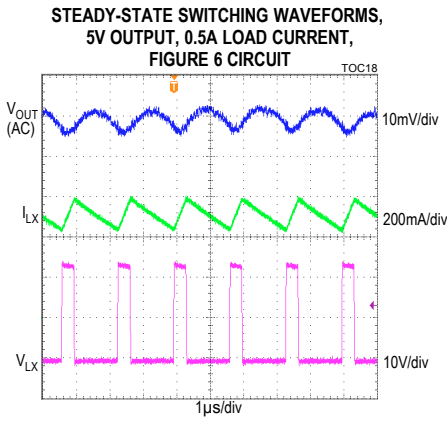
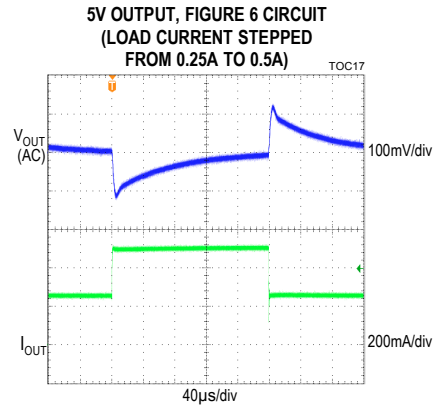
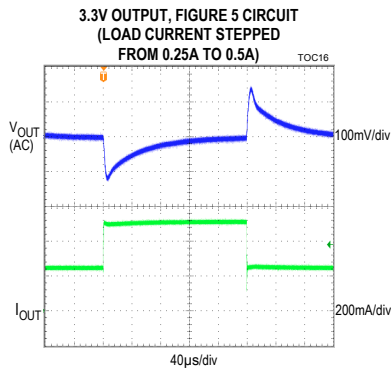

Measured on the MAX17541GTBEVKIT with input filter—  
 $C_{IN} = 2.2\mu F$ ,  $L_{IN} = 4.7\mu H$ ,  $2.2\mu F$  additional input capacitor used.

Pin Configurations

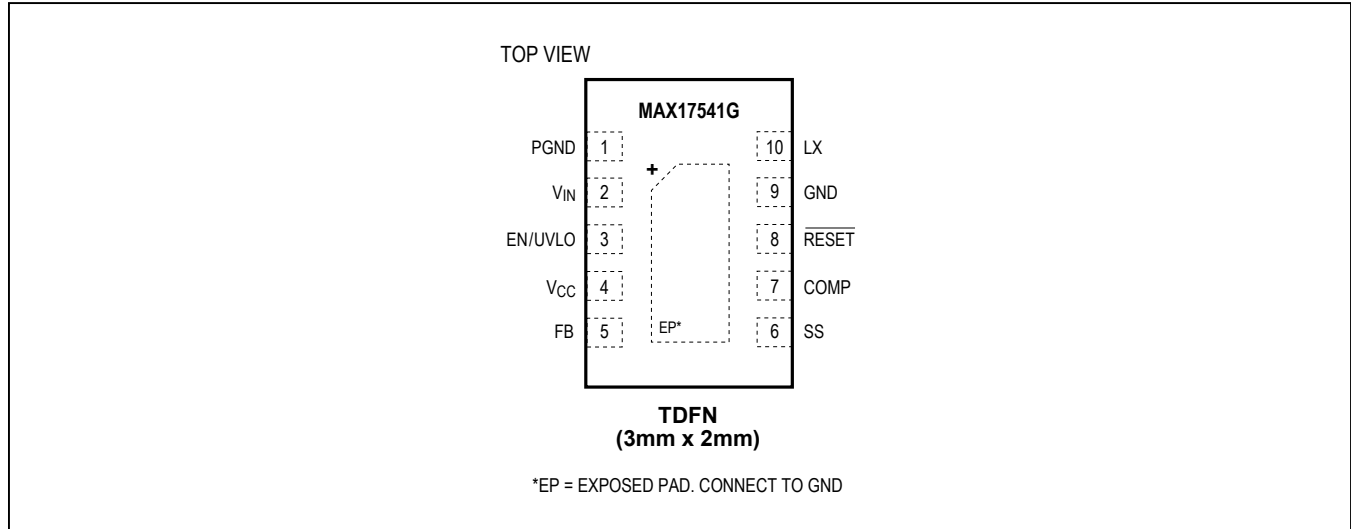

Pin Description

PIN	NAME	FUNCTION
1	PGND	Power Ground. Connect PGND externally to the power ground plane. Connect GND and PGND pins together at the ground return path of the V <sub>CC</sub> bypass capacitor.
2	V <sub>IN</sub>	Power Supply Input. The input supply range is from 4.5V to 42V.
3	EN/UVLO	Enable/Undervoltage Lockout Input. Drive EN/UVLO high to enable the output voltage. Connect to the center of the resistive divider between V <sub>IN</sub> and GND to set the input voltage (undervoltage threshold) at which the device turns on. Pull up to V <sub>IN</sub> for always on.
4	V <sub>CC</sub>	5V LDO Output. Bypass V <sub>CC</sub> with 1μF ceramic capacitance to GND.
5	FB	Feedback Input. Connect FB to the center of the resistive divider between V <sub>OUT</sub> and GND.
6	SS	Soft-Start Input. Connect a capacitor from SS to GND to set the soft-start time.
7	COMP	External Loop Compensation. Connect an RC network from COMP to GND. See External Loop Compensation for Adjustable Output Versions section for more details.
8	RESET	Open-Drain RESET Output. The RESET output is driven low if FB drops below 92.5% of its set value. RESET goes high 1024 clock cycles after FB rises above 95.5% of its set value. RESET is valid when the device is enabled and V <sub>IN</sub> is above 4.5V.
9	GND	Analog Ground
10	LX	Switching Node. Connect LX to the switching side of the inductor. LX is high impedance when the device is in shutdown mode.
—	EP	Exposed Pad. Connect to the GND pin of the IC. Connect to a large copper plane below the IC to improve heat dissipation capability.



Block Diagram

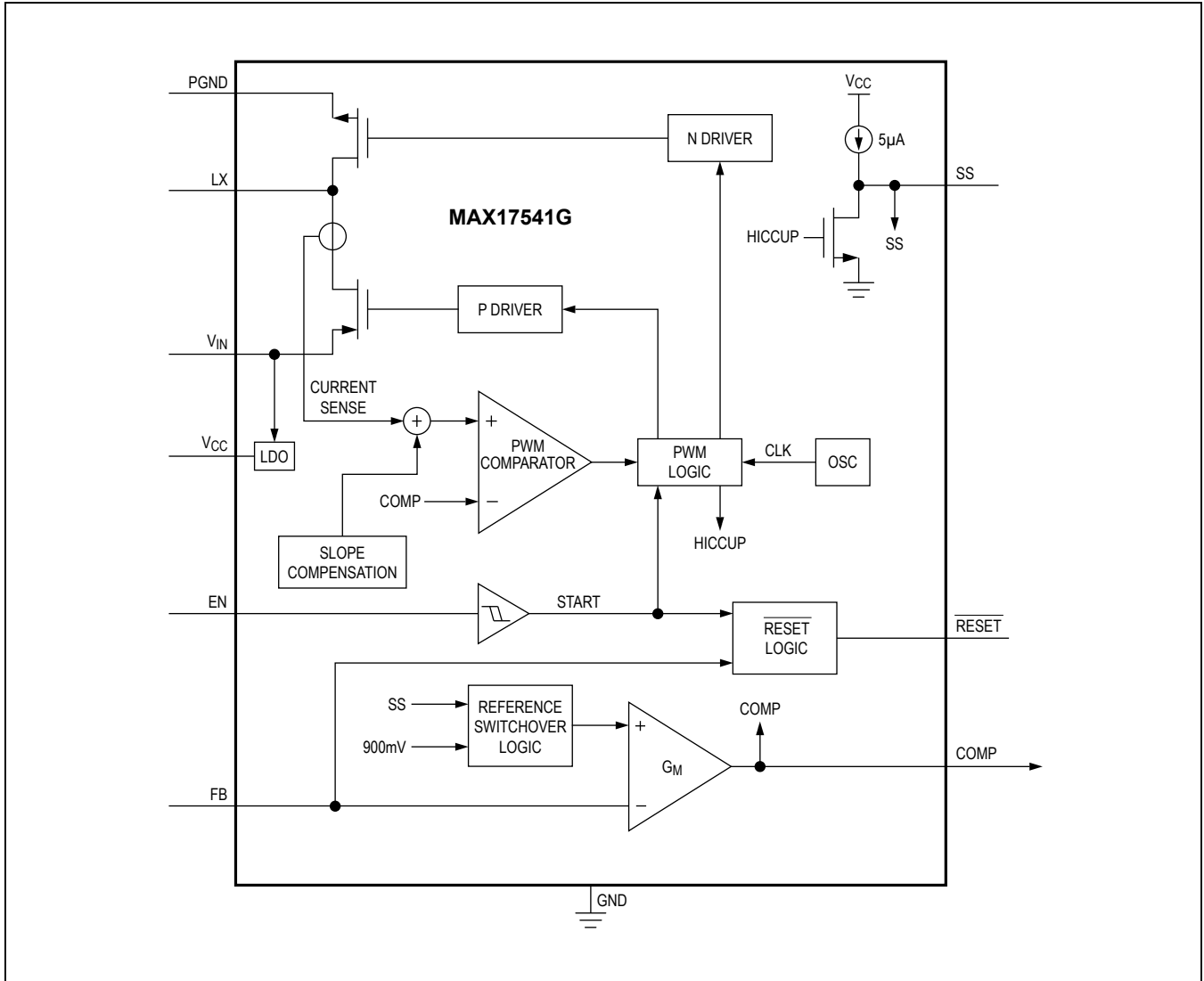

## Detailed Description

The MAX17541G synchronous step-down regulator operates from 4.5V to 42V and delivers up to 500mA load current. Output voltage regulation accuracy meets  $\pm 1.7\%$  over temperature.

The device uses a peak-current-mode control scheme. An internal transconductance error amplifier generates an integrated error voltage. The error voltage sets the duty cycle using a PWM comparator, a high-side current-sense amplifier, and a slope-compensation generator. At each rising edge of the clock, the high-side pMOSFET turns on and remains on until either the appropriate or maximum duty cycle is reached, or the peak current limit is detected.

During the high-side MOSFET's on-time, the inductor current ramps up. During the second half of the switching cycle, the high-side MOSFET turns off and the low-side nMOSFET turns on and remains on until either the next rising edge of the clock arrives or sink current limit is detected. The inductor releases the stored energy as its current ramps down, and provides current to the output (the internal low  $R_{DS(on)}$  pMOS/nMOS switches ensure high efficiency at full load).

This device also integrates enable/undervoltage lockout (EN/UVLO), adjustable soft-start time (SS), and open-drain reset output (RESET) functionality.

### Linear Regulator ( $V_{CC}$ )

An internal linear regulator ( $V_{CC}$ ) provides a 5V nominal supply to power the internal blocks and the low-side MOSFET driver. The output of the  $V_{CC}$  linear regulator should be bypassed with a  $1\mu\text{F}$  ceramic capacitor to GND. The device employs an undervoltage-lockout circuit that disables the internal linear regulator when  $V_{CC}$  falls below 3.7V (typical). The internal  $V_{CC}$  linear regulator can source up to 40mA (typical) to supply the device and to power the low-side gate driver.

### Operating Input Voltage Range

The maximum operating input voltage is determined by the minimum controllable on-time and the minimum operating input voltage is determined by the maximum duty cycle and circuit voltage drops. The minimum and maximum operating input voltages for a given output voltage should be calculated as:

$$V_{IN(MIN)} = \frac{V_{OUT} + (I_{OUT(MAX)} \times (R_{DCR} + 0.47))}{0.92} + (I_{OUT(MAX)} \times 0.73)$$

$$V_{IN(MAX)} = 13 \times V_{OUT}$$

where  $V_{OUT}$  is the steady-state output voltage,  $I_{OUT(MAX)}$  is the maximum load current,  $R_{DCR}$  is the DC resistance of the inductor

### Overcurrent Protection/HICCUP Mode

The device is provided with a robust overcurrent-protection scheme that protects the device under overload and output short-circuit conditions. A cycle-by-cycle peak current limit turns off the high-side MOSFET whenever the high-side switch current exceeds an internal limit of 0.76A (typ). A runaway current limit on the high-side switch current at 0.78A (typ) protects the device under high input voltage, short-circuit conditions when there is insufficient output voltage available to restore the inductor current that built up during the on period of the step-down converter. One occurrence of the runaway current limit triggers a hiccup mode. In addition, if due to a fault condition, output voltage drops to 71.14% (typ) of its nominal value any time after soft-start is complete, hiccup mode is triggered.

In hiccup mode, the converter is protected by suspending switching for a hiccup timeout period of 32,768 clock cycles. Once the hiccup timeout period expires, soft-start is attempted again. This operation results in minimal power dissipation under overload fault conditions.

### RESET Output

The device includes a  $\overline{\text{RESET}}$  comparator to monitor the output voltage. The open-drain  $\overline{\text{RESET}}$  output requires an external pullup resistor.  $\overline{\text{RESET}}$  can sink 2mA of current while low.  $\overline{\text{RESET}}$  goes high (high impedance) 1024 switching cycles after the regulator output increases above 95.5% of the designated nominal regulated voltage.  $\overline{\text{RESET}}$  goes low when the regulator output voltage drops to below 92.5% of the nominal regulated voltage.  $\overline{\text{RESET}}$  also goes low during thermal shutdown.  $\overline{\text{RESET}}$  is valid when the device is enabled and  $V_{IN}$  is above 4.5V.

### Prebiased Output

When the device starts into a prebiased output, both the high-side and low-side switches are turned off so the converter does not sink current from the output. High-side and low-side switches do not start switching until the PWM comparator commands the first PWM pulse, at which point switching commences first with the high-side switch. The output voltage is then smoothly ramped up to the target value in alignment with the internal reference.

### Thermal-Overload Protection

Thermal-overload protection limits total power dissipation in the device. When the junction temperature of the device exceeds +165°C, an on-chip thermal sensor shuts down the device, allowing the device to cool. The thermal sensor turns the device on again after the junction temperature cools by 10°C. Soft-start resets during thermal shutdown. Carefully evaluate the total power dissipation (see the [Power Dissipation](#) section) to avoid unwanted triggering of the thermal-overload protection in normal operation.

## Applications Information

### Input Capacitor Selection

The discontinuous input-current waveform of the buck converter causes large ripple currents in the input capacitor. The switching frequency, peak inductor current, and the allowable peak-to-peak voltage ripple that reflects back to the source dictate the capacitance requirement. The device's high switching frequency allows the use of smaller value input capacitors. X7R capacitors are recommended in industrial applications for their temperature stability. A minimum value of 1µF should be used for the input capacitor. Higher values help reduce the ripple on the input DC bus further. In applications where the source is located distant from the device input, an electrolytic capacitor should be added in parallel to the 1µF ceramic capacitor to provide necessary damping for potential oscillations caused by the longer input power path and input ceramic capacitor.

### Inductor Selection

Three key inductor parameters must be specified for operation with the device: inductance value (L), inductor saturation current (I<sub>SAT</sub>), and DC resistance (R<sub>DCR</sub>). The output voltage determines the inductor value as follows:

$$L = 8 \times V_{OUT}$$

where L is in µH.

Select a low-loss inductor closest to the calculated value with acceptable dimensions and having the lowest possible DC resistance. The saturation current rating (I<sub>SAT</sub>) of the inductor must be high enough to ensure that saturation can occur only above the peak current-limit value (I<sub>PEAK-LIMIT</sub> (typ) = 0.76A for the device).

### Output Capacitor Selection

X7R ceramic output capacitors are preferred due to their stability over temperature in industrial applications. The output capacitor is usually sized to support a step load of 50% of the maximum output current in the application, so the output-voltage deviation is contained to ±3% of the output-voltage change.

The output capacitance can be calculated as follows:

$$C_{OUT} = \frac{1}{2} \times \frac{I_{STEP} \times t_{RESPONSE}}{\Delta V_{OUT}}$$

$$t_{RESPONSE} \cong \frac{0.33}{f_C} + \frac{1}{f_{SW}}$$

where I<sub>STEP</sub> is the load current step, t<sub>RESPONSE</sub> is the response time of the controller, ΔV<sub>OUT</sub> is the allowable output-voltage deviation, f<sub>C</sub> is the target closed-loop crossover frequency, and f<sub>SW</sub> is the switching frequency (600kHz). Select f<sub>C</sub> to be 1/12th of f<sub>SW</sub>. Derating of ceramic capacitors with DC-voltage must be considered while selecting the output capacitor. Derating curves are available from all major ceramic capacitor vendors.

### Soft-Start Capacitor Selection

The device implements adjustable soft-start operation to reduce inrush current. A capacitor connected from the SS pin to GND programs the soft-start time. The selected output capacitance (C<sub>SEL</sub>) and the output voltage (V<sub>OUT</sub>) determine the minimum required soft-start capacitor as follows:

$$C_{SS} \geq 30 \times 10^{-6} \times C_{SEL} \times V_{OUT}$$

The soft-start time (t<sub>SS</sub>) is related to the capacitor connected at SS (C<sub>SS</sub>) by the following equation:

$$t_{SS} = \frac{C_{SS}}{5.55 \times 10^{-6}}$$

### Adjusting Output Voltage

The MAX17541G offers an adjustable output voltage from 0.9V to 92%V<sub>IN</sub>. Set the output voltage with a resistive voltage-divider connected from the positive terminal of the output capacitor (V<sub>OUT</sub>) to GND (see [Figure 1](#)). Connect the center node of the divider to FB. To optimize efficiency and output accuracy, use the following procedure to choose the values of R4 and R5:

$$R4 = 16 \times V_{OUT}$$

where R4 is in kΩ.

Calculate R5 as follows:

$$R5 = \frac{R4 \times 0.9}{(V_{OUT} - 0.9)}$$

**Setting the Input Undervoltage Lockout Level**

The device offers an adjustable input undervoltage-lockout level. Set the voltage at which the device turns on with a resistive voltage-divider connected from V<sub>IN</sub> to GND (see Figure 2). Connect the center node of the divider to EN/UVLO.

Choose R1 to be 3.3MΩ, and then calculate R2 as:

$$R2 = \frac{R1 \times 1.218}{(V_{INU} - 1.218)}$$

where V<sub>INU</sub> is the voltage at which the device is required to turn on. Ensure that V<sub>INU</sub> is higher than 0.8 x V<sub>OUT</sub>. If the EN/UVLO pin is driven from an external signal source, a series resistance of minimum 1kΩ is recommended to be placed between the signal source output and the EN/UVLO pin, to reduce voltage ringing on the line.

**External Loop Compensation**

The MAX17541G uses peak current-mode control scheme and needs only a simple RC network to have a stable, high-bandwidth control loop for the adjustable output voltage versions. The basic regulator loop is modeled as a power modulator, an output feedback divider, and an error amplifier. The power modulator has DC gain G<sub>MOD(dc)</sub>, with a pole and zero pair. The following equation defines the power modulator DC gain:

$$G_{MOD(dc)} = \frac{1}{\frac{1}{R_{LOAD}} + \frac{0.2}{V_{IN}} + \left( \frac{0.5 - D}{f_{SW} \times L_{SEL}} \right)}$$

where R<sub>LOAD</sub> = V<sub>OUT</sub>/I<sub>OUT(MAX)</sub>, f<sub>SW</sub> is the switching frequency (600kHz), L<sub>SEL</sub> is the selected output inductance, D is the duty ratio, D = V<sub>OUT</sub>/V<sub>IN</sub>.

The compensation network is shown in Figure 3.

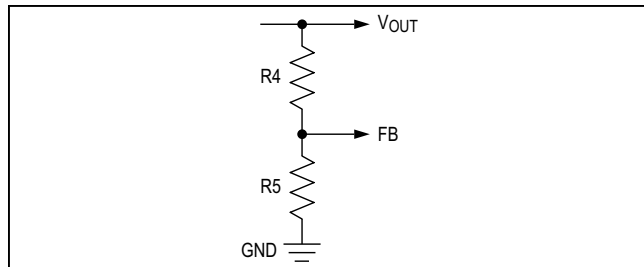

Figure 1. Setting the Output Voltage

R<sub>Z</sub> can be calculated as:

$$R_Z = 12000 \times f_C \times C_{SEL} \times V_{OUT}$$

where R<sub>Z</sub> is in Ω. Choose f<sub>C</sub> to be 1/12th of the switching frequency.

C<sub>Z</sub> can be calculated as follows:

$$C_Z = \frac{C_{SEL} \times G_{MOD(dc)}}{R_Z}$$

C<sub>P</sub> can be calculated as follows:

$$C_P = \frac{1}{\pi \times R_Z \times f_{SW}}$$

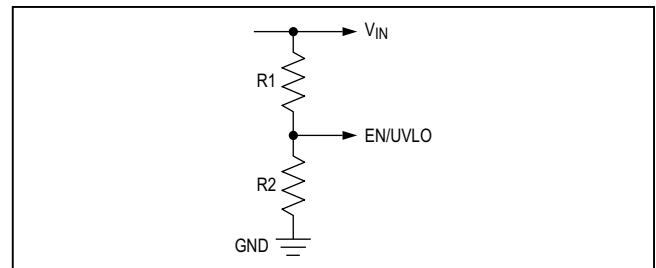

Figure 2. Adjustable EN/UVLO Network

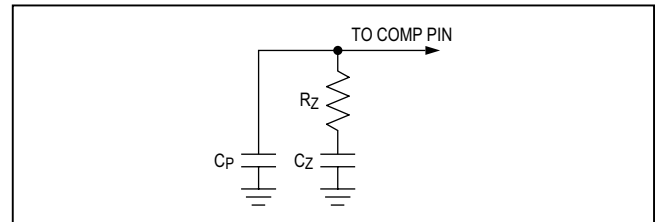

Figure 3. External Compensation Network

### Power Dissipation

At a particular operating condition, the power losses that lead to temperature rise of the device are estimated as follows:

$$P_{\text{LOSS}} = (P_{\text{OUT}} \times (\frac{1}{\eta} - 1)) - (I_{\text{OUT}}^2 \times R_{\text{DCR}})$$

$$P_{\text{OUT}} = V_{\text{OUT}} \times I_{\text{OUT}}$$

where  $P_{\text{OUT}}$  is the output power,  $\eta$  is the efficiency of the device, and  $R_{\text{DCR}}$  is the DC resistance of the output inductor (refer to the *Typical Operating Characteristics* section in the evaluation kit data sheet for more information on efficiency at typical operating conditions).

For a typical multilayer board, the thermal performance metrics for the package are given as:

$$\theta_{\text{JA}} = 67.3^\circ\text{C/W}$$

$$\theta_{\text{JC}} = 18.2^\circ\text{C/W}$$

The junction temperature of the device can be estimated at any given maximum ambient temperature ( $T_{\text{A\_MAX}}$ ) from the following equation:

$$T_{\text{J\_MAX}} = T_{\text{A\_MAX}} + (\theta_{\text{JA}} \times P_{\text{LOSS}})$$

If the application has a thermal-management system that ensures that the exposed pad of the device is maintained at a given temperature ( $T_{\text{EP\_MAX}}$ ) by using proper heat sinks, then the junction temperature of the device can be estimated at any given maximum ambient temperature as:

$$T_{\text{J\_MAX}} = T_{\text{EP\_MAX}} + (\theta_{\text{JC}} \times P_{\text{LOSS}})$$

Junction temperature greater than  $+125^\circ\text{C}$  degrades operating lifetimes.

### PCB Layout Guidelines

Careful PCB layout is critical to achieve low switching losses and stable operation. For a sample layout that ensures first-pass success, refer to the MAX17541G evaluation kit layouts available at [www.maximintegrated.com](http://www.maximintegrated.com). Follow these guidelines for good PCB layout:

- 1) All connections carrying pulsed currents must be very short and as wide as possible. The loop area of these connections must be made very small to reduce stray inductance and radiated EMI.
- 2) A ceramic input filter capacitor should be placed close to the  $V_{\text{IN}}$  pin of the device. The bypass capacitor for the  $V_{\text{CC}}$  pin should also be placed close to the  $V_{\text{CC}}$  pin. External compensation components should be placed close to the IC and far from the inductor. The feedback trace should be routed as far as possible from the inductor.
- 3) The analog small-signal ground and the power ground for switching currents must be kept separate. They should be connected together at a point where switching activity is at minimum, typically the return terminal of the  $V_{\text{CC}}$  bypass capacitor. The ground plane should be kept continuous as much as possible.
- 4) A number of thermal vias that connect to a large ground plane should be provided under the exposed pad of the device, for efficient heat dissipation.

[Figure 5](#) shows the recommended component placement for the MAX17541G.

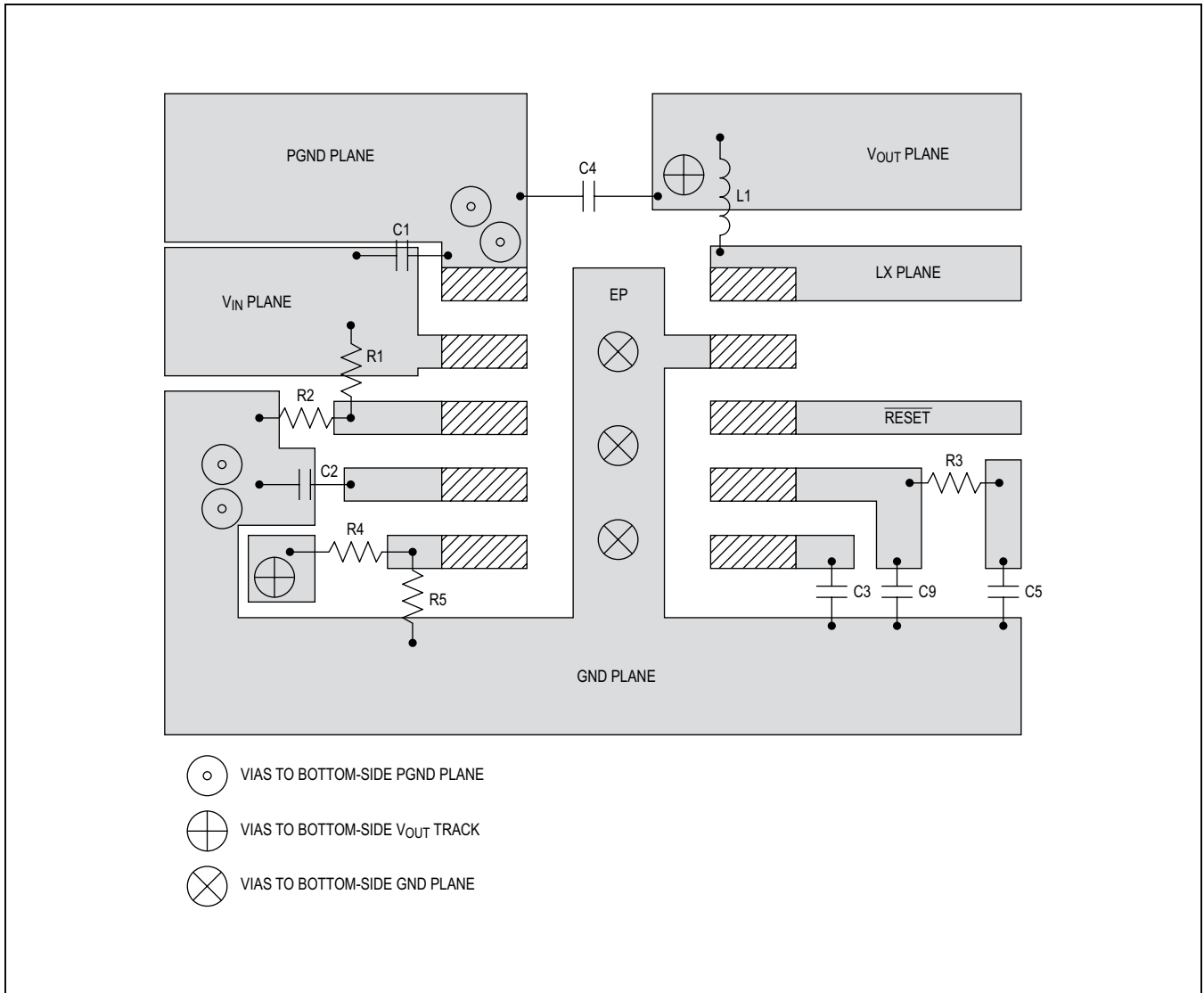

Figure 4. Recommended Component Placement for MAX17541G

Typical Applications Circuits

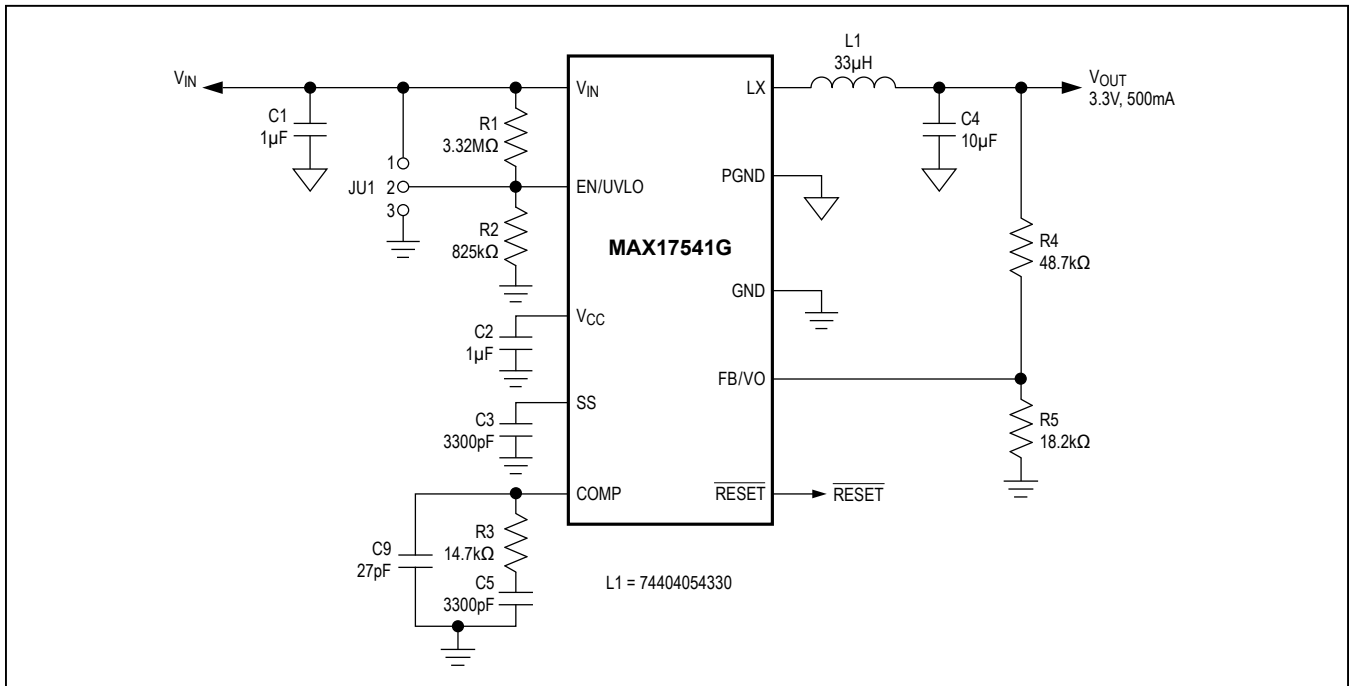

Figure 5. MAX17541G Application Circuit (3.3V Output, 500mA Maximum Load Current)

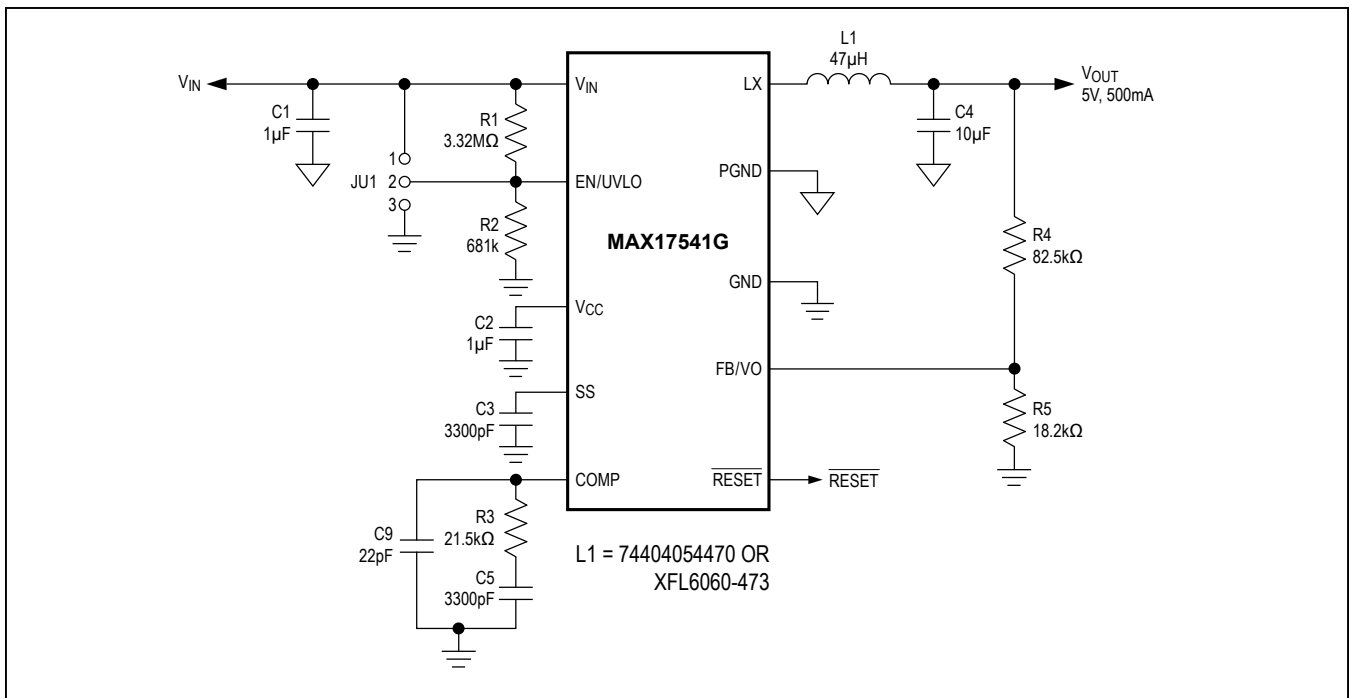

Figure 6. MAX17541G Application Circuit (5V Output, 500mA Maximum Load Current)

MAX17541G

42V, 500mA, Ultra-Small, High-Efficiency,  
Synchronous Step-Down DC-DC Converter

### Ordering Information

PART	PIN-PACKAGE
MAX17541GATB+	10 TDFN-EP*

+Denotes a lead(Pb)-free/RoHS-compliant package.

\*EP = Exposed pad.

### Chip Information

PROCESS: BiCMOS

### Package Information

For the latest package outline information and land patterns (footprints), go to [www.maximintegrated.com/packages](http://www.maximintegrated.com/packages). Note that a "+", "#", or "-" in the package code indicates RoHS status only. Package drawings may show a different suffix character, but the drawing pertains to the package regardless of RoHS status.

PACKAGE TYPE	PACKAGE CODE	OUTLINE NO.	LAND PATTERN NO.
10 TDFN	T1032N+1	<a href="#">21-0429</a>	<a href="#">90-0082</a>



MAX17541G

42V, 500mA, Ultra-Small, High-Efficiency,  
Synchronous Step-Down DC-DC Converter

## Revision History

REVISION NUMBER	REVISION DATE	DESCRIPTION	PAGES CHANGED
0	6/15	Initial release	—
1	7/16	Updated operating and junction temperature values, added text and TOC	1–7, 11–13

For pricing, delivery, and ordering information, please contact Maxim Direct at 1-888-629-4642, or visit Maxim Integrated's website at [www.maximintegrated.com](http://www.maximintegrated.com).

*Maxim Integrated cannot assume responsibility for use of any circuitry other than circuitry entirely embodied in a Maxim Integrated product. No circuit patent licenses are implied. Maxim Integrated reserves the right to change the circuitry and specifications without notice at any time. The parametric values (min and max limits) shown in the Electrical Characteristics table are guaranteed. Other parametric values quoted in this data sheet are provided for guidance.*

# Mouser Electronics

Authorized Distributor

Click to View Pricing, Inventory, Delivery & Lifecycle Information:

[Maxim Integrated:](#)

[MAX17541GATB+T](#) [MAX17541GATB+](#)