

# Driver or Pre-driver Amplifier for Doherty Power Amplifiers

## GaAs Enhancement Mode pHEMT

The MMG20241H is a 1/4 W high gain amplifier designed as a driver or pre-driver for Doherty power amplifiers in wireless infrastructure equipment operating in the 450 to 3800 MHz frequency range. Because of its versatile design, the device may also be used in a variety of general purpose amplifier applications, including frequencies below 450 MHz and above 3800 MHz.

### Features

- P1dB: 24 dBm @ 2655 MHz
- Gain: 17.8 dB @ 2655 MHz
- Designed as a Doherty PA Driver or Pre-driver
- 5 V Single Supply, 78 mA Current
- SOT-89 Package
- 50 Ohm Operation with Minimal External Matching
- In Tape and Reel. T1 Suffix = 1,000 Units, 12 mm Tape Width, 7-inch Reel.

**MMG20241HT1**

**450–3800 MHz, 17.8 dB @ 2655 MHz  
24.5 dBm  
DRIVER AMPLIFIER**



**SOT-89**

**Table 1. Typical Performance (1)**

Characteristic	Symbol	1915 MHz	2140 MHz	2350 MHz	2595 MHz	2655 MHz	3700 MHz	Unit
Small-Signal Gain (S21)	$G_p$	20	19.5	18	17.5	17.8	14.7	dB
Power Output @ 1dB Compression	P1dB	24.5	24.5	23.8	24	23.9	24.1	dBm
Third Order Output Intercept Point	OIP3	34.9	37	34.9	37.5	38	38.1	dBm
Input Return Loss (S11)	IRL	-19	-24	-12	-14	-14	-17	dB
Output Return Loss (S22)	ORL	-11	-13	-18	-14	-16	-15	dB
Noise Figure	NF	1.9	2	1.9	2.2	2.1	1.9	dB

**Table 2. Maximum Ratings**

Rating	Symbol	Value	Unit
Supply Voltage	$V_{DD}$	6	V
Supply Current	$I_{DD}$	130	mA
RF Input Power	$P_{in}$	23	dBm
Storage Temperature Range	$T_{stg}$	-65 to +150	°C
Junction Temperature	$T_J$	175	°C

**Table 3. Thermal Characteristics**

Characteristic	Symbol	Value (2)	Unit
Thermal Resistance, Junction to Case Case Temperature 88°C, 5 Vdc, 85 mA, no RF applied	$R_{\theta JC}$	57	°C/W

1.  $V_{DD} = 5$  Vdc,  $T_A = 25^\circ\text{C}$ , 50 ohm system, application circuit tuned for specified frequency.

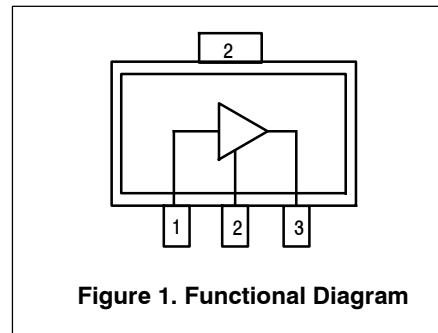
2. Refer to AN1955, *Thermal Measurement Methodology of RF Power Amplifiers*. Go to <http://www.freescale.com/rf>. Select Documentation/Application Notes - AN1955.

**Table 4. Electrical Characteristics** ( $V_{DD} = 5 \text{ Vdc}$ , 2140 MHz,  $T_A = 25^\circ\text{C}$ , 50 ohm system, in Freescale Application Circuit)

Characteristic	Symbol	Min	Typ	Max	Unit
Small-Signal Gain (S21)	$G_p$	18.4	19.5	—	dB
Power Output @ 1dB Compression	P1dB	—	24.5	—	dBm
Third Order Output Intercept Point	OIP3	—	37	—	dBm
Input Return Loss (S11)	IRL	—	-24	—	dB
Output Return Loss (S22)	ORL	—	-13	—	dB
Noise Figure	NF	—	2	—	dB
Supply Current	$I_{DD}$	64	78	104	mA
Supply Voltage	$V_{DD}$	—	5	—	V

**Table 5. Functional Pin Description**

Pin Number	Pin Function
1	$RF_{in}$
2	Ground
3	$RF_{out}/DC \text{ Supply}$



**Table 6. ESD Protection Characteristics**

Test Methodology	Class
Human Body Model (per JESD 22-A114)	1A
Machine Model (per EIA/JESD 22-A115)	A
Charge Device Model (per JESD 22-C101)	IV

**Table 7. Moisture Sensitivity Level**

Test Methodology	Rating	Package Peak Temperature	Unit
Per JESD22-A113, IPC/JEDEC J-STD-020	1	260	$^\circ\text{C}$

### 50 OHM APPLICATION CIRCUIT: 2110–2170 MHz

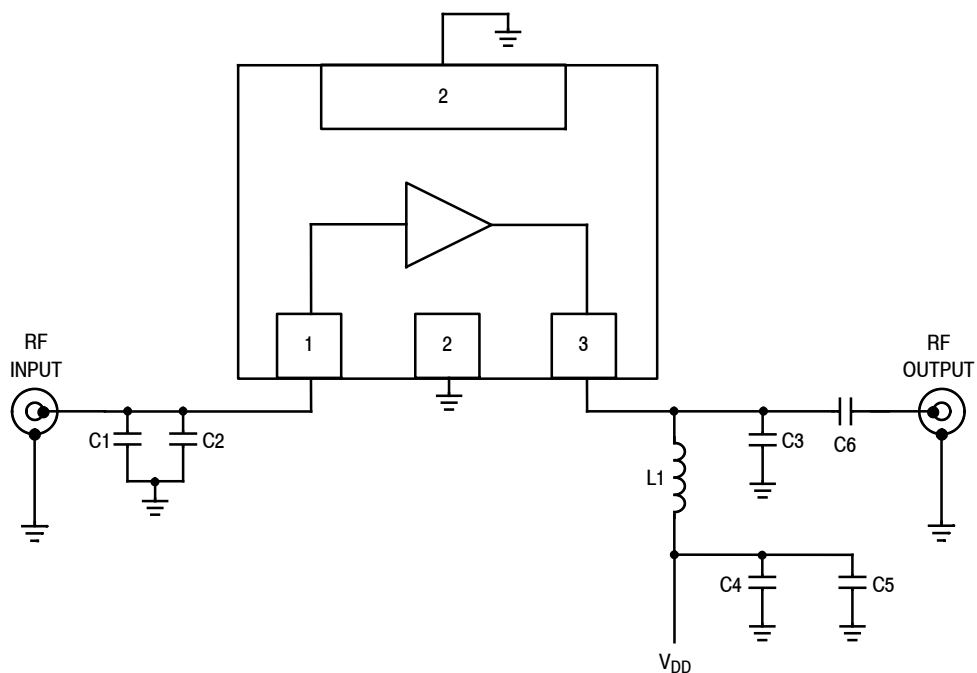
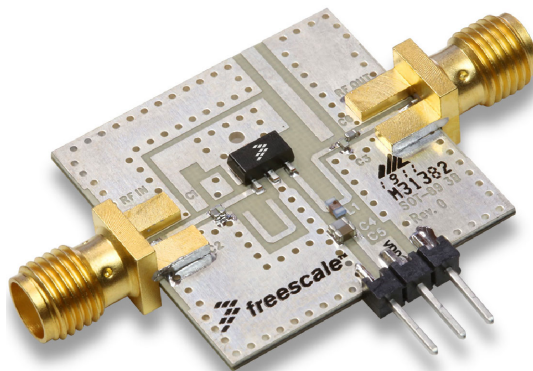
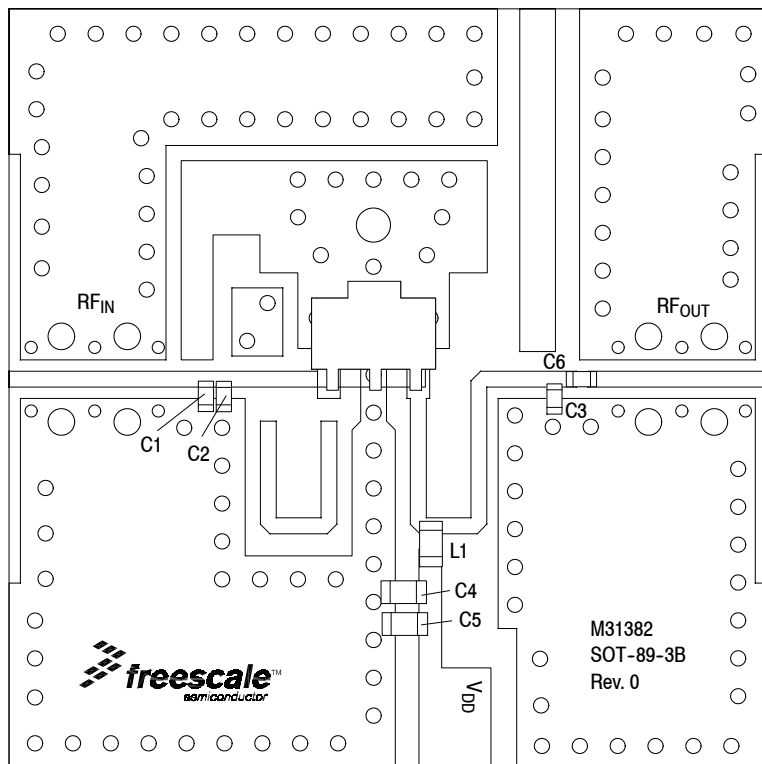


Figure 2. MMG20241HT1 Test Circuit Schematic

Table 8. MMG20241HT1 Test Circuit Component Designations and Values

Part	Description	Part Number	Manufacturer
C1	3.0 pF Chip Capacitor	GRM1555C1H3R0BB01B	Murata
C2	0.4 pF Chip Capacitor	RVEVK105 CH0R4BW-F	Taiyo Yuden
C3	0.7 pF Chip Capacitor	RVEVK105 CH0R7BW-F	Taiyo Yuden
C4	56 pF Chip Capacitor	GRM188RC1H560GA01D	Murata
C5	0.1 $\mu$ F Chip Capacitor	GRM188R71H104KA93D	Murata
C6	5.6 pF Chip Capacitor	GRM1555C1H5R6BA01D	Murata
L1	30 nH Chip Inductor	0603CS-30NXJLW	Coilcraft
PCB	Isola IS680-338, 0.010", $\epsilon_r = 3.38$	M31382	MTL

### 50 OHM APPLICATION CIRCUIT: 2110–2170 MHz



PCB actual size: 1" × 1".

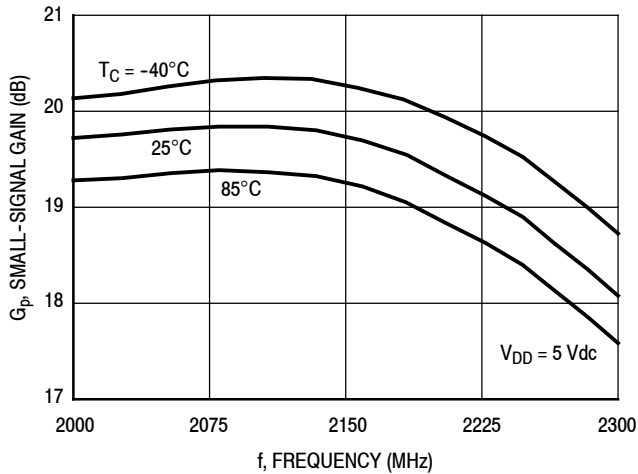
**Figure 3. MMG20241HT1 Test Circuit Component Layout**

**Table 8. MMG20241HT1 Test Circuit Component Designations and Values**

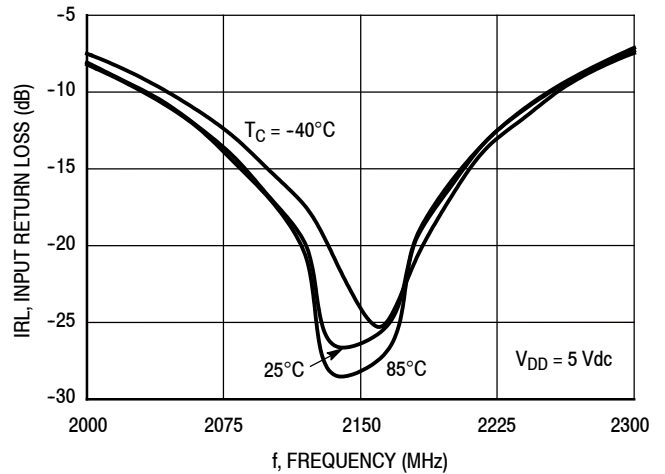
Part	Description	Part Number	Manufacturer
C1	3.0 pF Chip Capacitor	GRM1555C1H3R0BB01B	Murata
C2	0.4 pF Chip Capacitor	RVEVK105 CH0R4BW-F	Taiyo Yuden
C3	0.7 pF Chip Capacitor	RVEVK105 CH0R7BW-F	Taiyo Yuden
C4	56 pF Chip Capacitor	GRM188RC1H560GA01D	Murata
C5	0.1 μF Chip Capacitor	GRM188R71H104KA93D	Murata
C6	5.6 pF Chip Capacitor	GRM1555C1H5R6BA01D	Murata
L1	30 nH Chip Inductor	0603CS-30NXJLW	Coilcraft
PCB	Isola IS680-338, 0.010", ε <sub>r</sub> = 3.38	M31382	MTL

(Test Circuit Component Designations and Values table repeated for reference.)

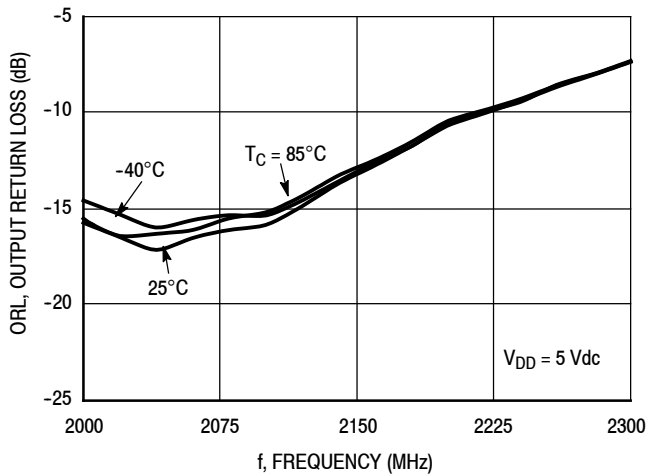
### 50 OHM TYPICAL CHARACTERISTICS: 2110–2170 MHz



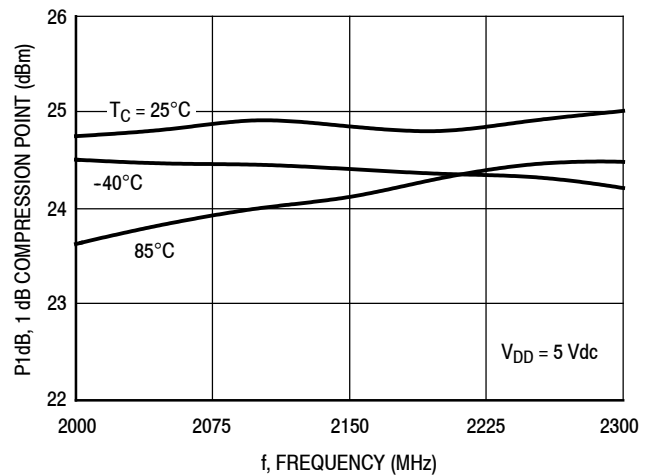
**Figure 4. Small-Signal Gain (S21) versus Frequency versus Temperature**



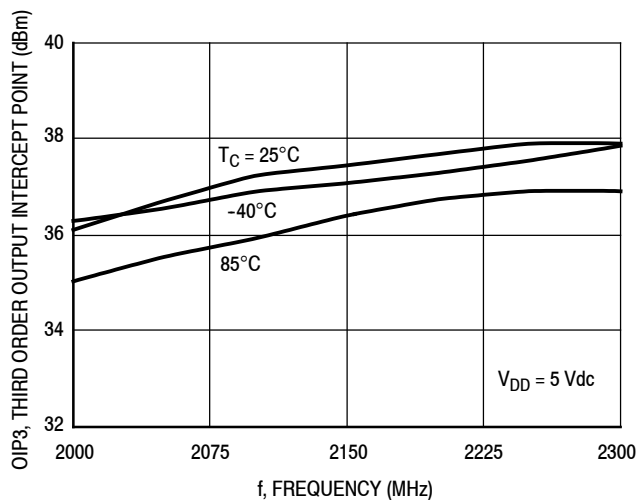
**Figure 5. Input Return Loss (S11) versus Frequency versus Temperature**



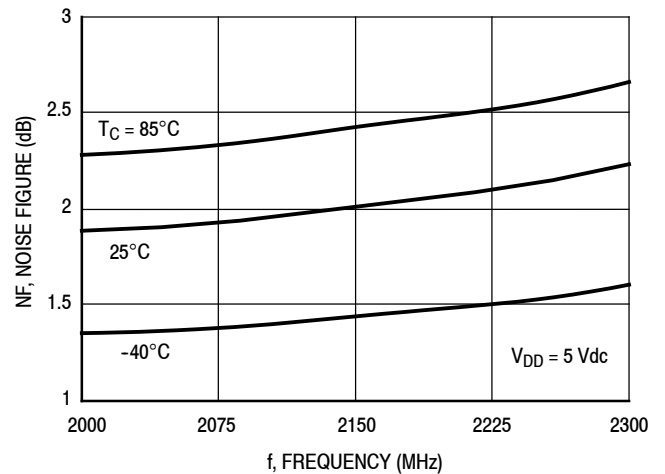
**Figure 6. Output Return Loss (S22) versus Frequency versus Temperature**



**Figure 7. P1dB versus Frequency versus Temperature**

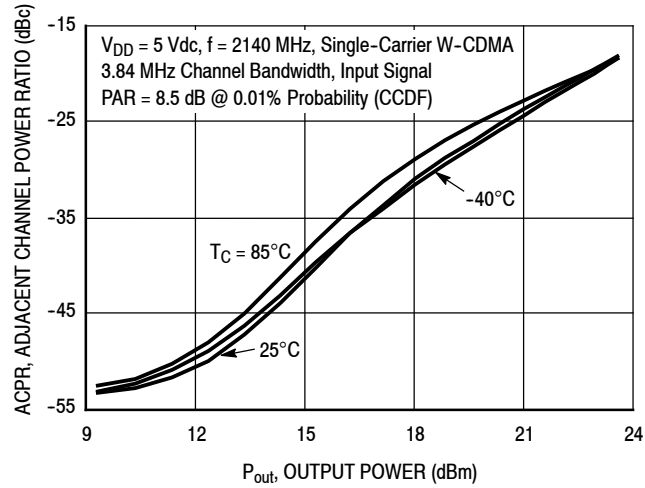


**Figure 8. Third Order Output Intercept Point versus Frequency versus Temperature**



**Figure 9. Noise Figure versus Frequency versus Temperature**

### 50 OHM TYPICAL CHARACTERISTICS: 2110–2170 MHz



**Figure 10. Single-Carrier W-CDMA Adjacent Channel Power Ratio versus Output Power versus Temperature**

### 50 OHM APPLICATION CIRCUIT: 2620–2690 MHz

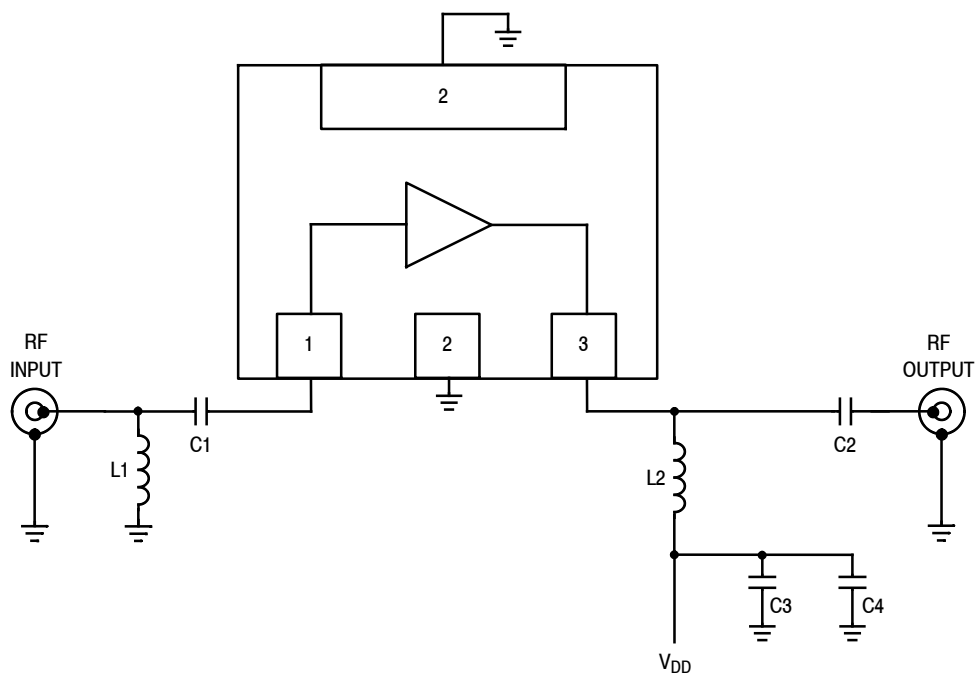
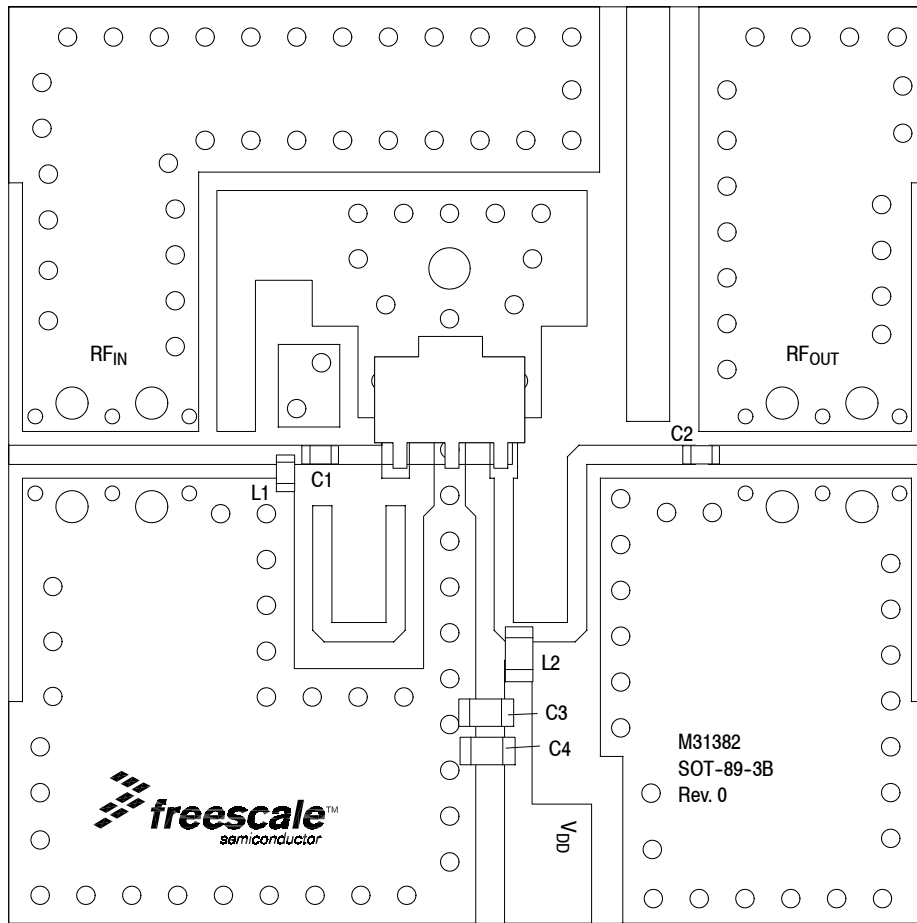


Figure 11. MMG20241HT1 Test Circuit Schematic

Table 9. MMG20241HT1 Test Circuit Component Designations and Values

Part	Description	Part Number	Manufacturer
C1	1.5 pF Chip Capacitor	GRM1555C1H1R5BA01D	Murata
C2	1 pF Chip Capacitor	GRM1555C1H1R0BA01D	Murata
C3	56 pF Chip Capacitor	GRM188RC1H560GA01D	Murata
C4	0.1 $\mu$ F Chip Capacitor	GRM188R71H104KA93D	Murata
L1	1 nH Chip Inductor	0402CS-1N0XJLW	Coilcraft
L2	8.2 nH Chip Inductor	0603CS-8N2XJL	Coilcraft
PCB	Isola IS680-338, 0.010", $\epsilon_r = 3.38$	M31382	MTL

### 50 OHM APPLICATION CIRCUIT: 2620–2690 MHz



PCB actual size: 1" × 1".

**Figure 12. MMG20241HT1 Test Circuit Component Layout**

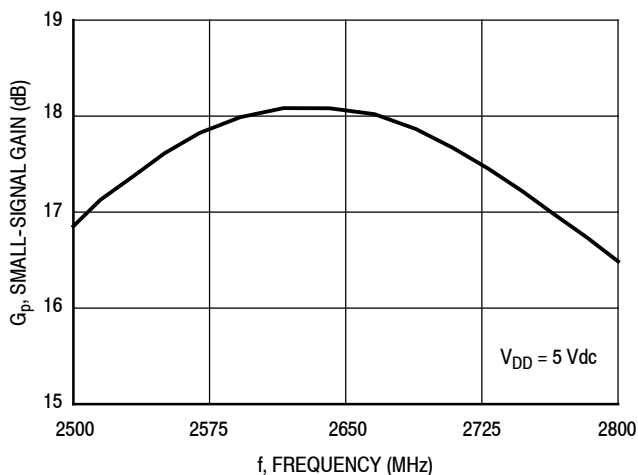
**Table 9. MMG20241HT1 Test Circuit Component Designations and Values**

Part	Description	Part Number	Manufacturer
C1	1.5 pF Chip Capacitor	GRM1555C1H1R5BA01D	Murata
C2	1 pF Chip Capacitor	GRM1555C1H1R0BA01D	Murata
C3	56 pF Chip Capacitor	GRM188RC1H560GA01D	Murata
C4	0.1 $\mu$ F Chip Capacitor	GRM188R71H104KA93D	Murata
L1	1 nH Chip Inductor	0402CS-1N0XJLW	Coilcraft
L2	8.2 nH Chip Inductor	0603CS-8N2XJL	Coilcraft
PCB	Isola IS680-338, 0.010", $\epsilon_r = 3.38$	M31382	MTL

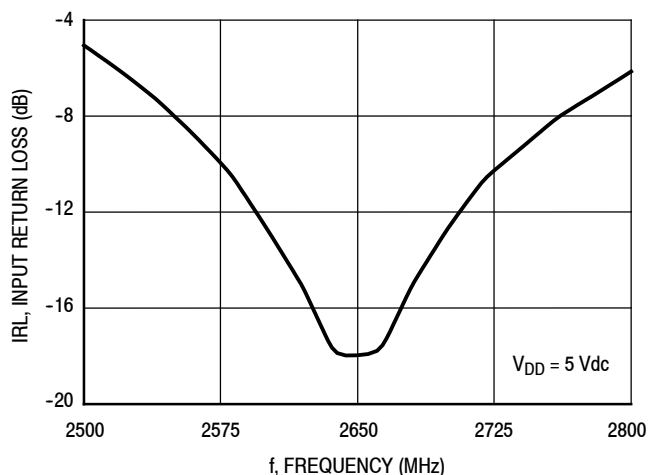
(Test Circuit Component Designations and Values table repeated for reference.)



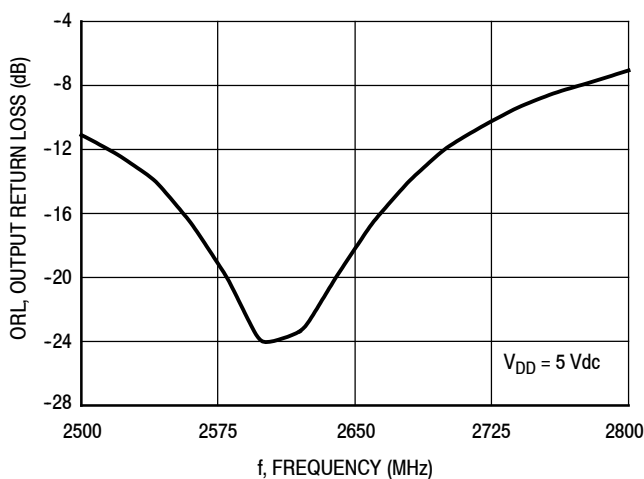
### 50 OHM TYPICAL CHARACTERISTICS: 2620–2690 MHz



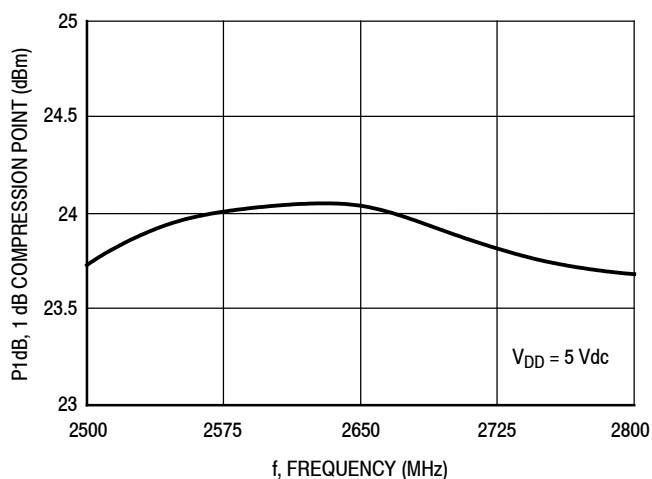
**Figure 13. Small-Signal Gain (S21) versus Frequency**



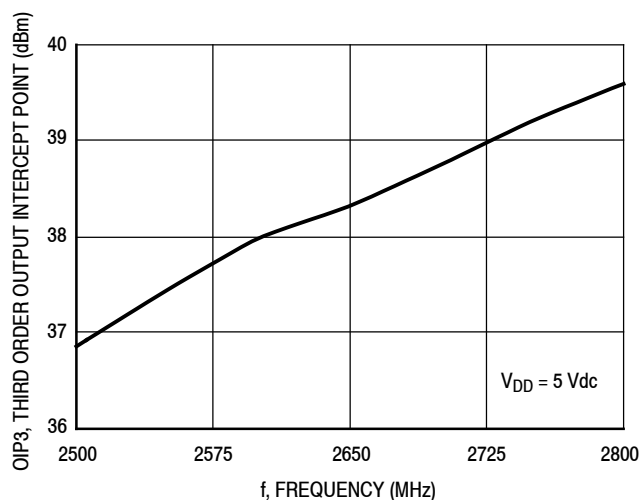
**Figure 14. Input Return Loss (S11) versus Frequency**



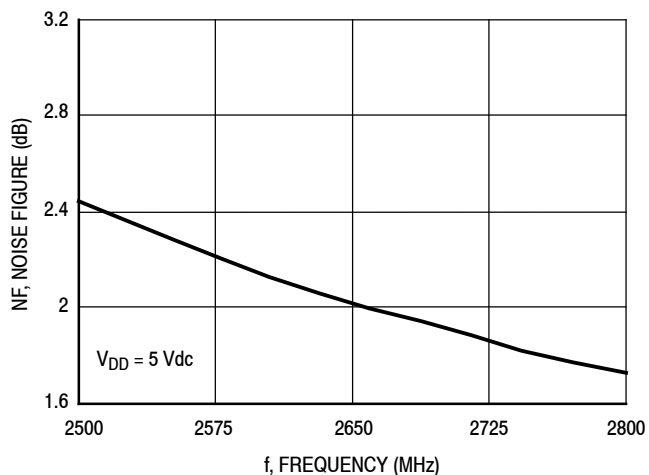
**Figure 15. Output Return Loss (S22) versus Frequency**



**Figure 16. P1dB versus Frequency**

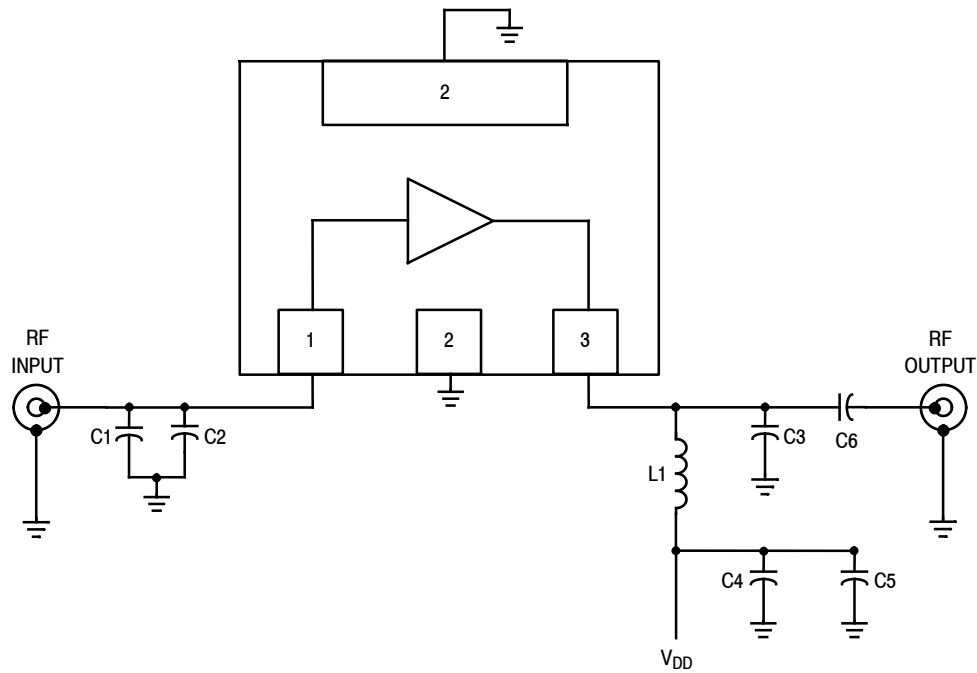


**Figure 17. Third Order Output Intercept Point versus Frequency**



**Figure 18. Noise Figure versus Frequency**

## 50 OHM APPLICATION CIRCUIT: 1805–2025 MHz

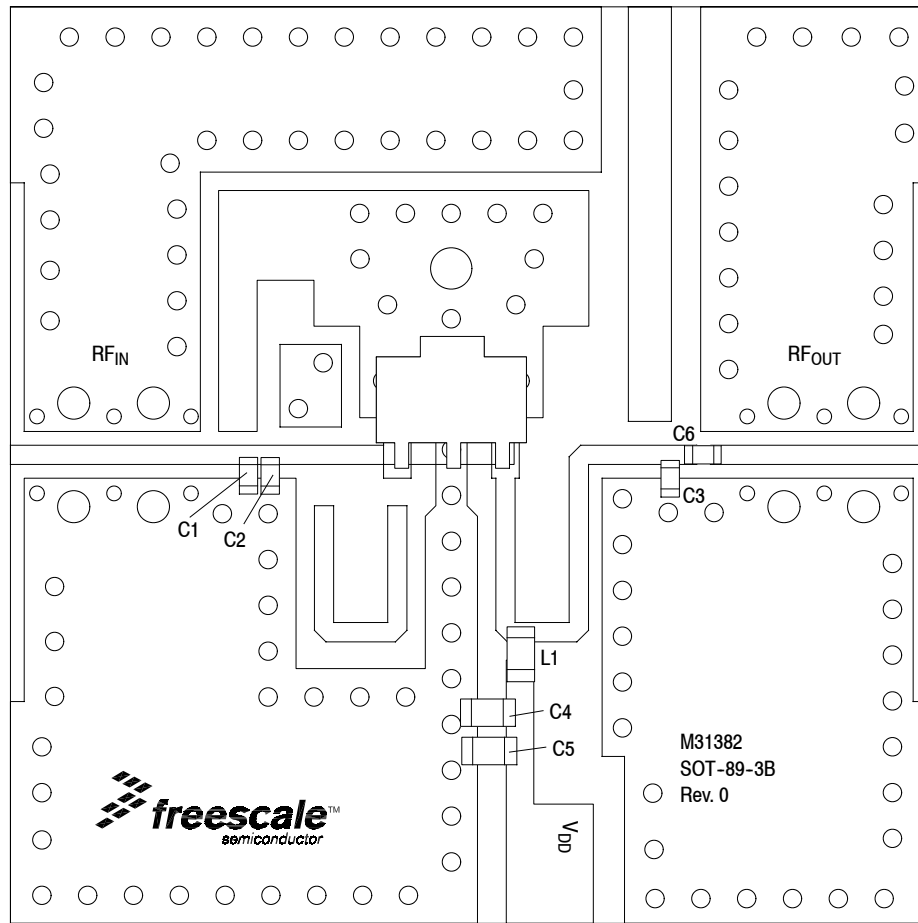


**Figure 19. MMG20241HT1 Test Circuit Schematic**

**Table 10. MMG20241HT1 Test Circuit Component Designations and Values**

Part	Description	Part Number	Manufacturer
C1	3.6 pF Chip Capacitor	GRM1555C1H3R6BB01B	Murata
C2	0.4 pF Chip Capacitor	RVEVK105 CH0R4BW	Taiyo Yuden
C3	0.6 pF Chip Capacitor	RVEVK105 CH0R6BW	Taiyo Yuden
C4	56 pF Chip Capacitor	GRM188RC1H560GA01D	Murata
C5	0.1 $\mu$ F Chip Capacitor	GRM188R71H104KA93D	Murata
C6	10 pF Chip Capacitor	GRM1555C1H100JA01D	Murata
L1	33 nH Chip Inductor	0603CS-33NXJLW	Coilcraft
PCB	Isola IS680-338, 0.010", $\epsilon_r = 3.38$	M31382	MTL

### 50 OHM APPLICATION CIRCUIT: 1805–2025 MHz



PCB actual size: 1" × 1".

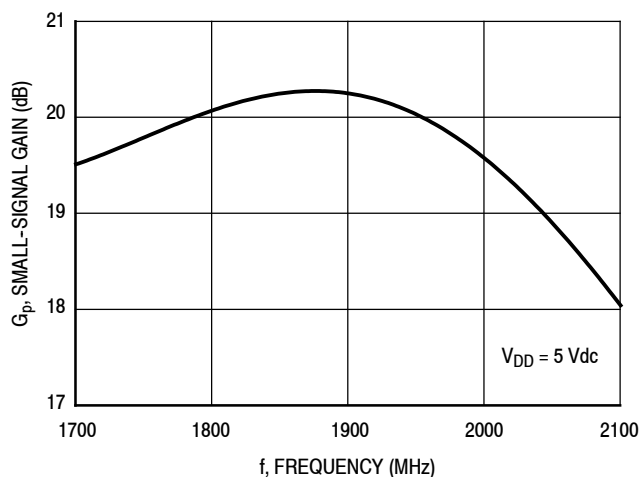
**Figure 20. MMG20241HT1 Test Circuit Component Layout**

**Table 10. MMG20241HT1 Test Circuit Component Designations and Values**

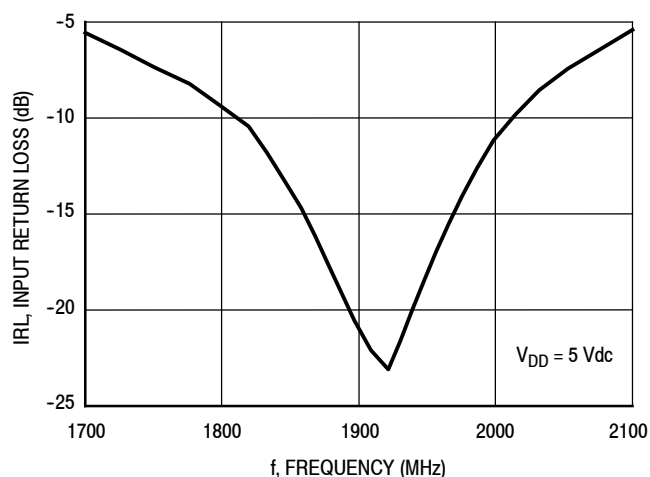
Part	Description	Part Number	Manufacturer
C1	3.6 pF Chip Capacitor	GRM1555C1H3R6BB01B	Murata
C2	0.4 pF Chip Capacitor	RVEVK105 CH0R4BW	Taiyo Yuden
C3	0.6 pF Chip Capacitor	RVEVK105 CH0R6BW	Taiyo Yuden
C4	56 pF Chip Capacitor	GRM188RC1H560GA01D	Murata
C5	0.1 μF Chip Capacitor	GRM188R71H104KA93D	Murata
C6	10 pF Chip Capacitor	GRM1555C1H100JA01D	Murata
L1	33 nH Chip Inductor	0603CS-33NXJLW	Coilcraft
PCB	Isola IS680-338, 0.010", $\epsilon_r = 3.38$	M31382	MTL

(Test Circuit Component Designations and Values table repeated for reference.)

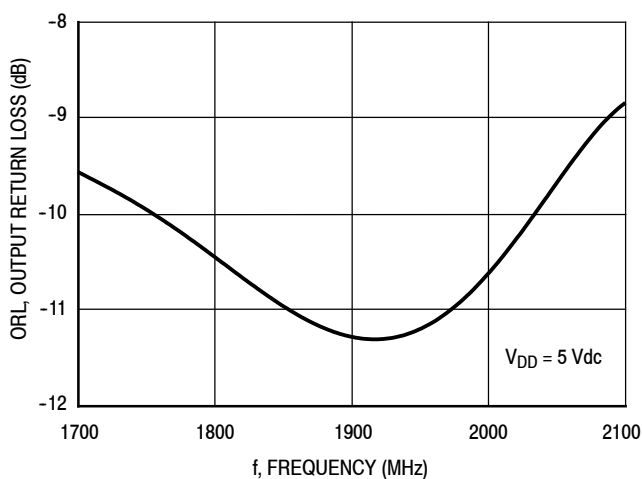
### 50 OHM TYPICAL CHARACTERISTICS: 1805–2025 MHz



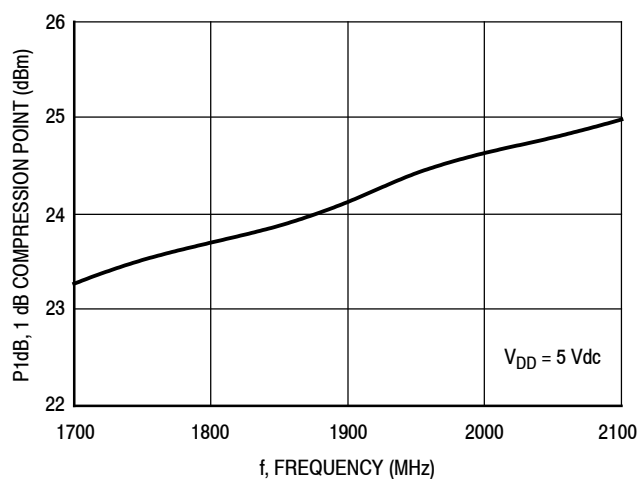
**Figure 21. Small-Signal Gain (S21) versus Frequency**



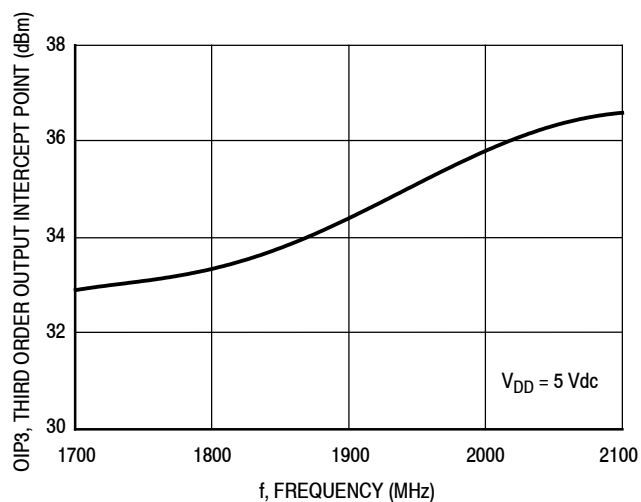
**Figure 22. Input Return Loss (S11) versus Frequency**



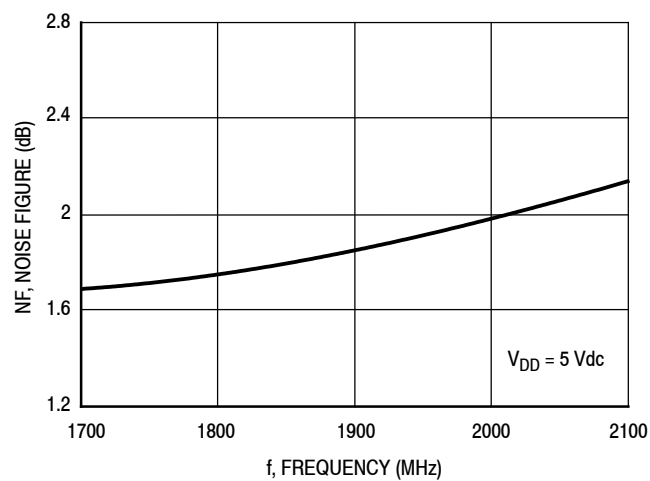
**Figure 23. Output Return Loss (S22) versus Frequency**



**Figure 24. P1dB versus Frequency**



**Figure 25. Third Order Output Intercept Point versus Frequency**



**Figure 26. Noise Figure versus Frequency**

### 50 OHM APPLICATION CIRCUIT: 2300–2400 MHz

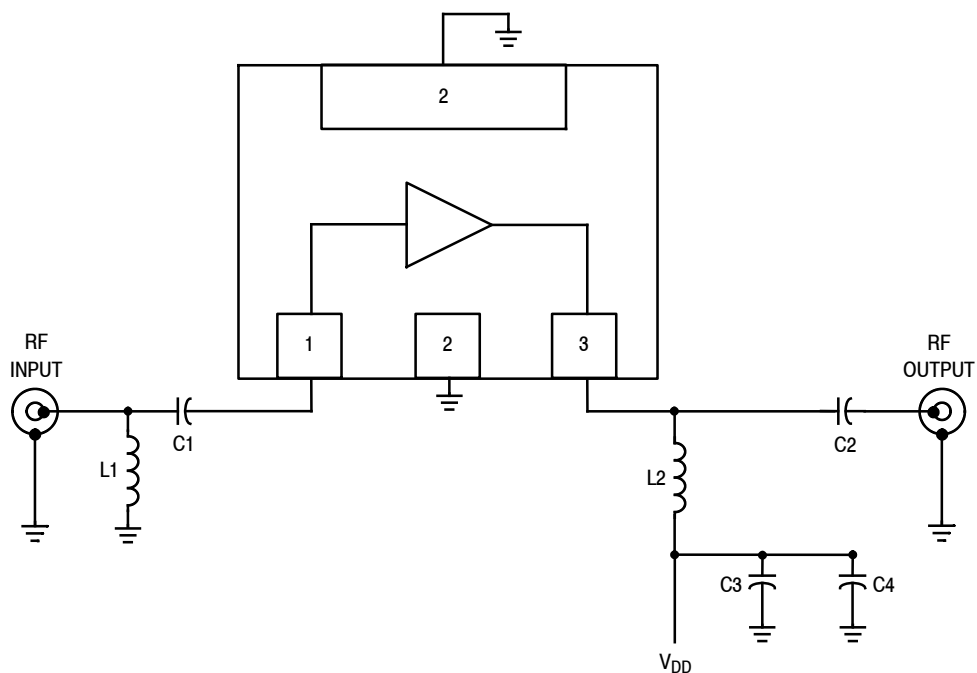
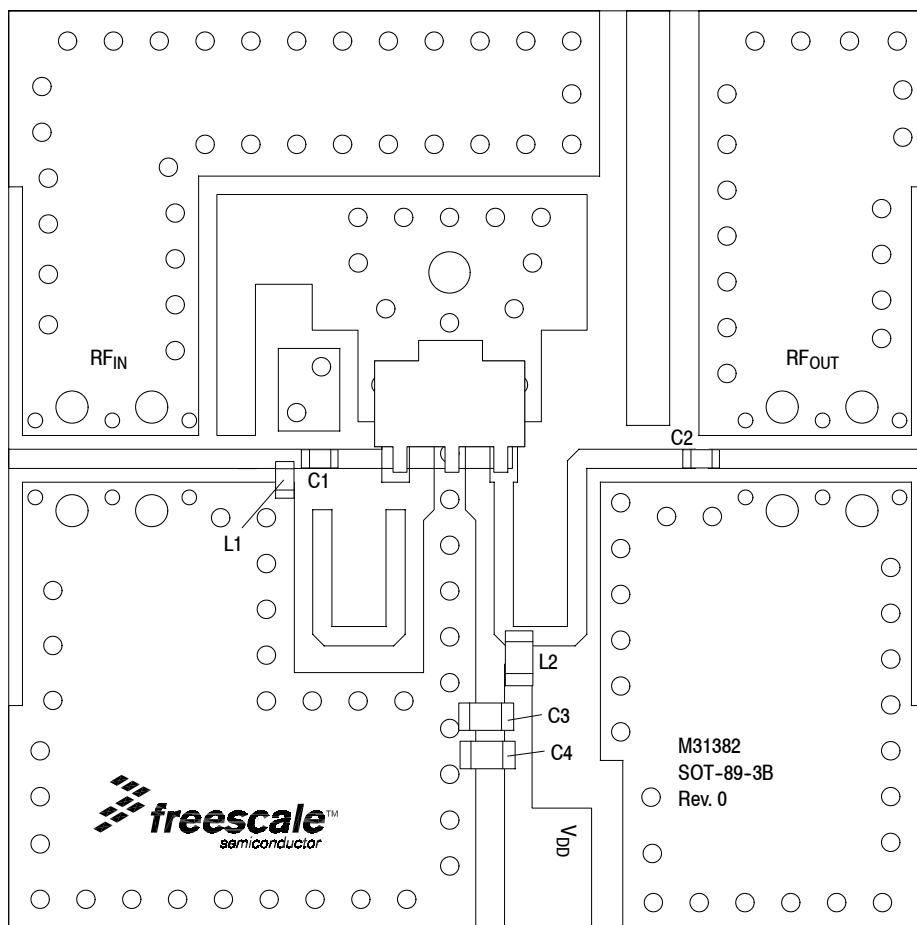


Figure 27. MMG20241HT1 Test Circuit Schematic

Table 11. MMG20241HT1 Test Circuit Component Designations and Values

Part	Description	Part Number	Manufacturer
C1	2 pF Chip Capacitor	GRM1555C1H2R0BA01D	Murata
C2	1.3 pF Chip Capacitor	GRM1555C1H1R3BA01D	Murata
C3	56 pF Chip Capacitor	GRM188RC1H560GA01D	Murata
C4	0.1 $\mu$ F Chip Capacitor	GRM188R71H104KA93D	Murata
L1	1 nH Chip Inductor	0402CS-1N0XJLW	Coilcraft
L2	8.2 nH Chip Inductor	0603CS-8N2XJL	Coilcraft
PCB	Isola IS680-338, 0.010", $\epsilon_r = 3.38$	M31382	MTL

### 50 OHM APPLICATION CIRCUIT: 2300–2400 MHz



PCB actual size: 1" × 1".

**Figure 28. MMG20241HT1 Test Circuit Component Layout**

**Table 11. MMG20241HT1 Test Circuit Component Designations and Values**

Part	Description	Part Number	Manufacturer
C1	2 pF Chip Capacitor	GRM1555C1H2R0BA01D	Murata
C2	1.3 pF Chip Capacitor	GRM1555C1H1R3BA01D	Murata
C3	56 pF Chip Capacitor	GRM188RC1H560GA01D	Murata
C4	0.1 μF Chip Capacitor	GRM188R71H104KA93D	Murata
L1	1 nH Chip Inductor	0402CS-1N0XJLW	Coilcraft
L2	8.2 nH Chip Inductor	0603CS-8N2XJL	Coilcraft
PCB	Isola IS680-338, 0.010", $\epsilon_r = 3.38$	M31382	MTL

(Test Circuit Component Designations and Values table repeated for reference.)

50 OHM TYPICAL CHARACTERISTICS: 2300–2400 MHz

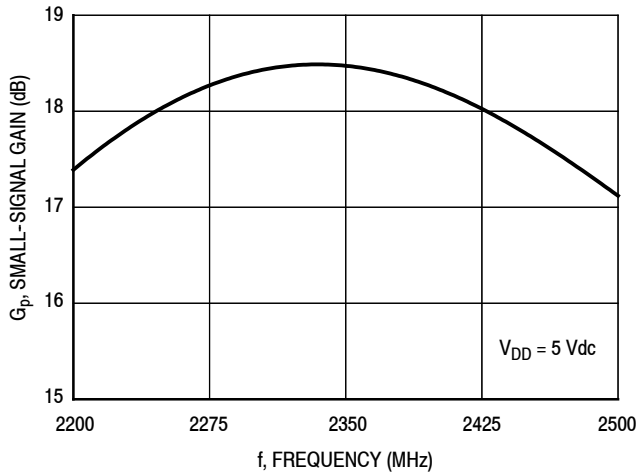


Figure 29. Small-Signal Gain (S21) versus Frequency

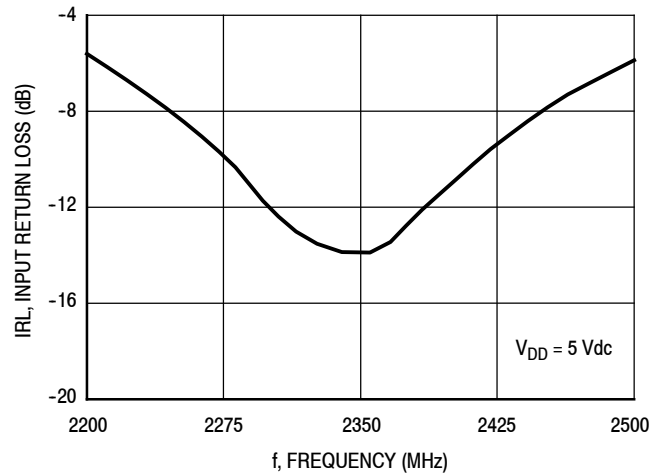


Figure 30. Input Return Loss (S11) versus Frequency

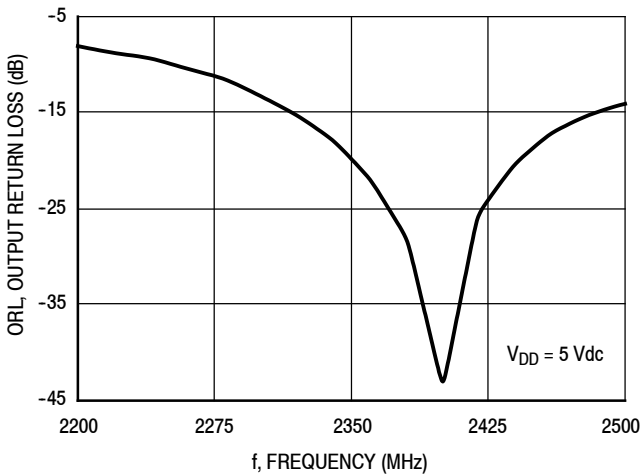


Figure 31. Output Return Loss (S22) versus Frequency

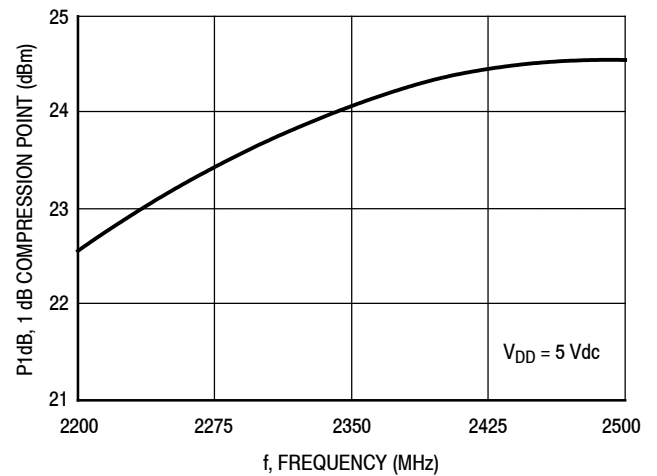


Figure 32. P1dB versus Frequency

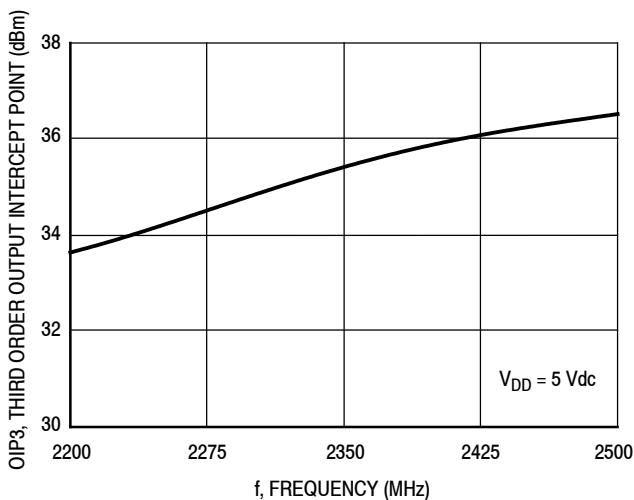


Figure 33. Third Order Output Intercept Point versus Frequency

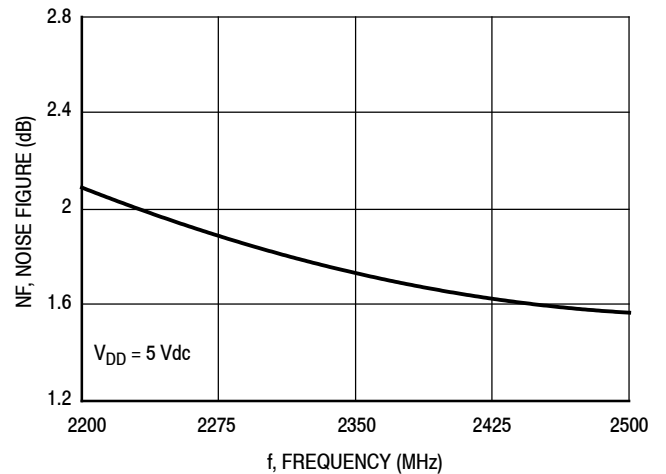


Figure 34. Noise Figure versus Frequency

### 50 OHM APPLICATION CIRCUIT: 2570–2620 MHz

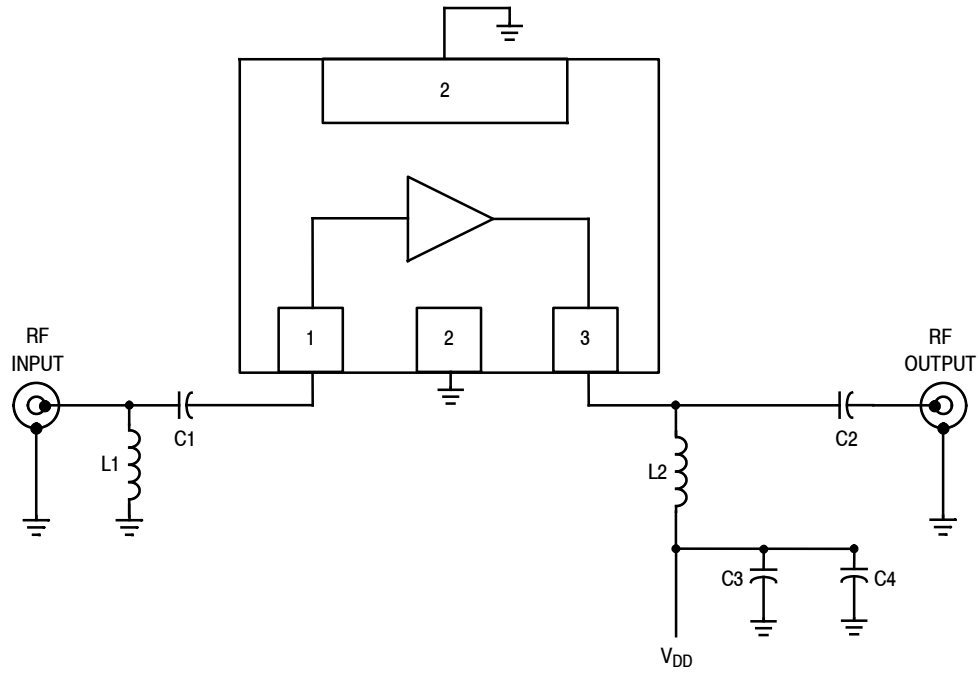


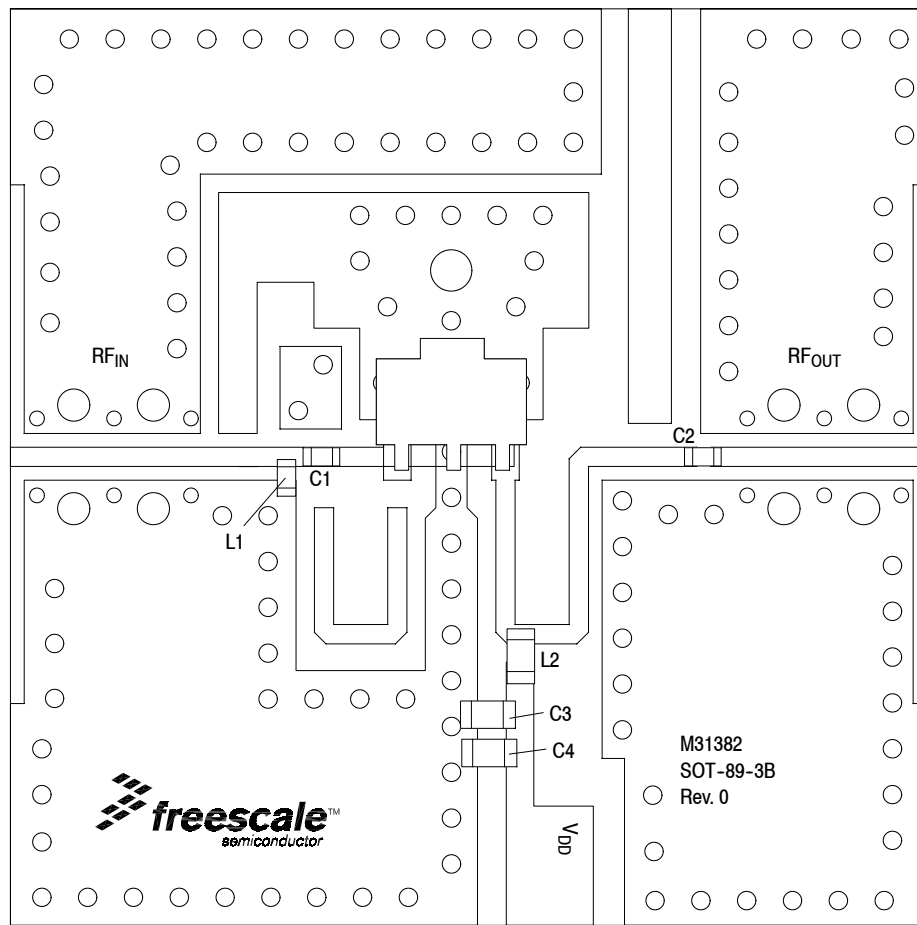
Figure 35. MMG20241HT1 Test Circuit Schematic

Table 12. MMG20241HT1 Test Circuit Component Designations and Values

Part	Description	Part Number	Manufacturer
C1	1.5 pF Chip Capacitor	GRM1555C1H1R5BA01D	Murata
C2	2 pF Chip Capacitor	GRM1555C1H2R0BA01D	Murata
C3	56 pF Chip Capacitor	GRM188RC1H560GA01D	Murata
C4	0.1 $\mu$ F Chip Capacitor	GRM188R71H104KA93D	Murata
L1	1 nH Chip Inductor	0402CS-1N0XJLW	Coilcraft
L2	8.2 nH Chip Inductor	0603CS-8N2XJL	Coilcraft
PCB	Isola IS680-338, 0.010", $\epsilon_r = 3.38$	M31382	MTL



### 50 OHM APPLICATION CIRCUIT: 2570–2620 MHz



PCB actual size: 1" × 1".

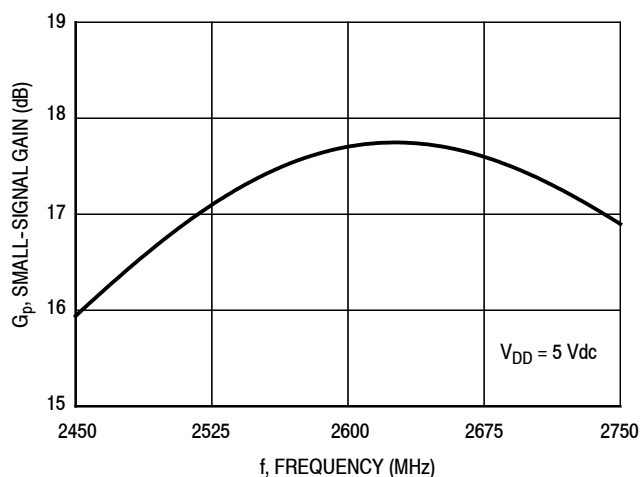
**Figure 36. MMG20241HT1 Test Circuit Component Layout**

**Table 12. MMG20241HT1 Test Circuit Component Designations and Values**

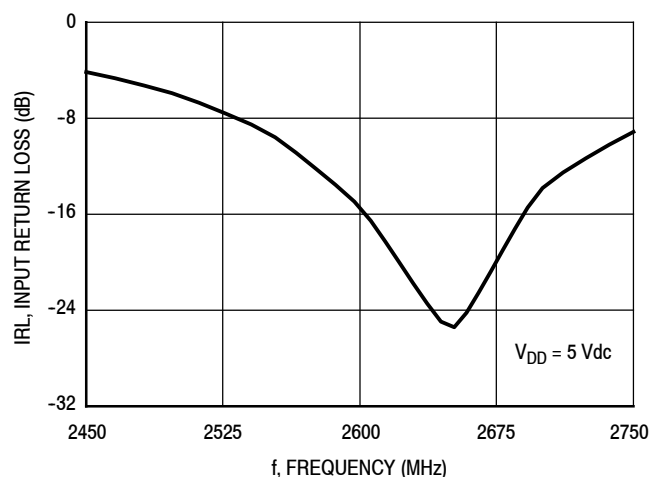
Part	Description	Part Number	Manufacturer
C1	1.5 pF Chip Capacitor	GRM1555C1H1R5BA01D	Murata
C2	2 pF Chip Capacitor	GRM1555C1H2R0BA01D	Murata
C3	56 pF Chip Capacitor	GRM188RC1H560GA01D	Murata
C4	0.1 $\mu$ F Chip Capacitor	GRM188R71H104KA93D	Murata
L1	1 nH Chip Inductor	0402CS-1N0XJLW	Coilcraft
L2	8.2 nH Chip Inductor	0603CS-8N2XJL	Coilcraft
PCB	Isola IS680-338, 0.010", $\epsilon_r = 3.38$	M31382	MTL

(Test Circuit Component Designations and Values table repeated for reference.)

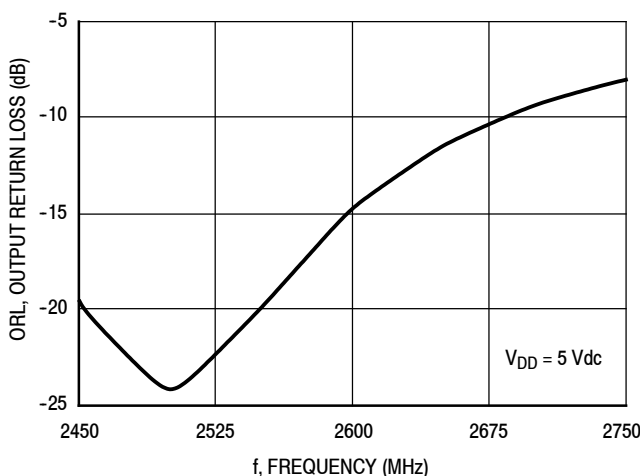
### 50 OHM TYPICAL CHARACTERISTICS: 2570–2620 MHz



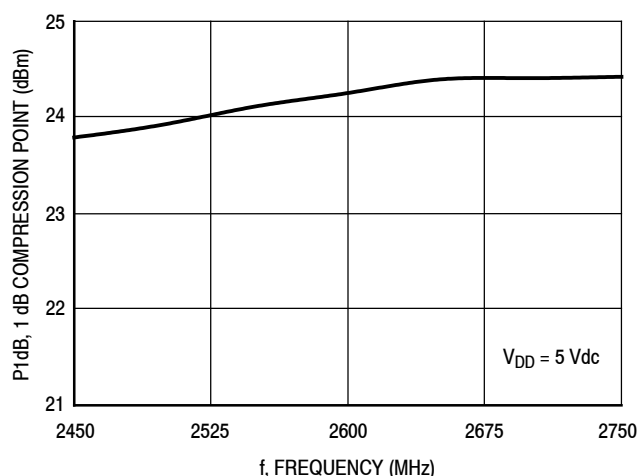
**Figure 37. Small-Signal Gain (S21) versus Frequency**



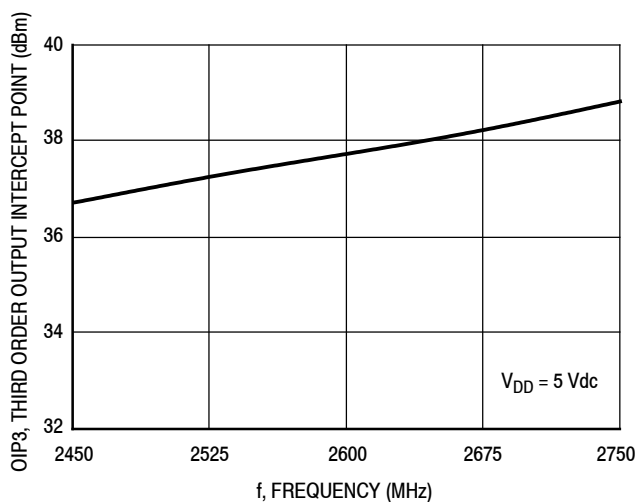
**Figure 38. Input Return Loss (S11) versus Frequency**



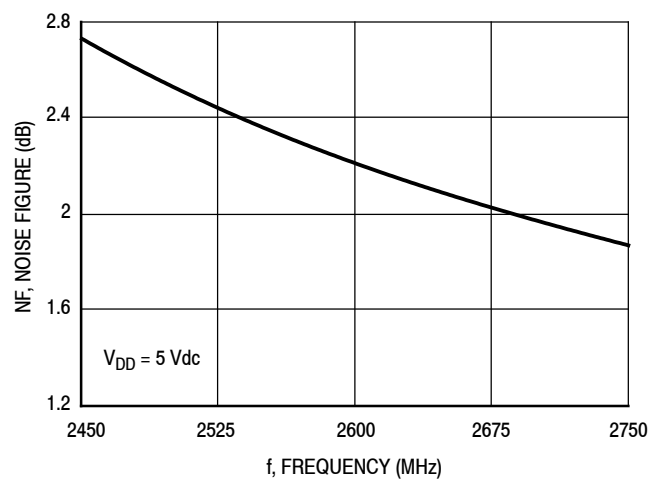
**Figure 39. Output Return Loss (S22) versus Frequency**



**Figure 40. P1dB versus Frequency**



**Figure 41. Third Order Output Intercept Point versus Frequency**



**Figure 42. Noise Figure versus Frequency**

### 50 OHM APPLICATION CIRCUIT: 3600–3800 MHz

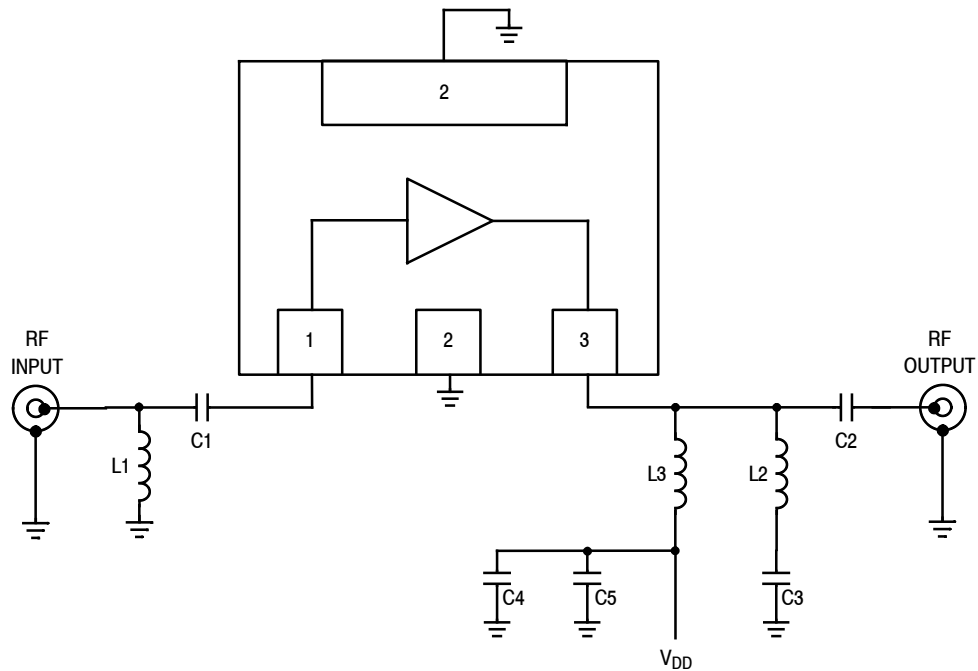
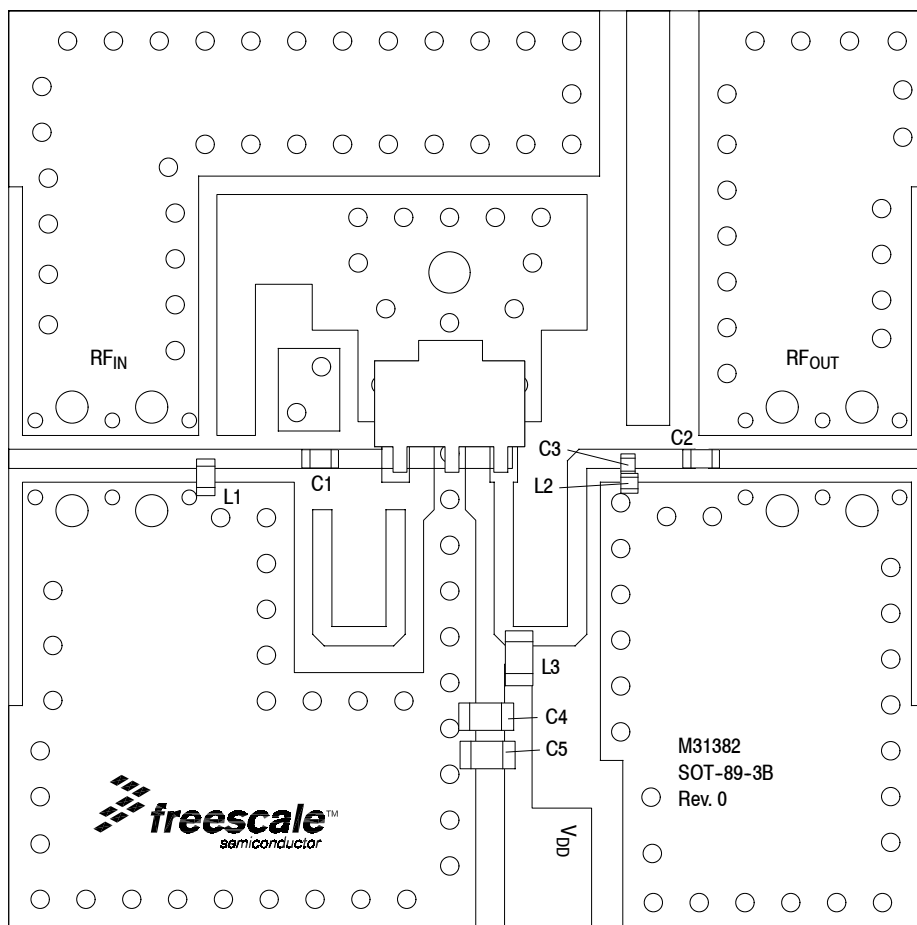


Figure 43. MMG20241HT1 Test Circuit Schematic

Table 13. MMG20241HT1 Test Circuit Component Designations and Values

Part	Description	Part Number	Manufacturer
C1	0.6 pF Chip Capacitor	RVEVK105CH0R6BW-F	Taiyo Yuden
C2	1 pF Chip Capacitor	GJM1555C1H1R0CB01D	Murata
C3	0.01 $\mu$ F Chip Capacitor	GRM155R71E103KA01D	Murata
C4	56 pF Chip Capacitor	GRM188RC1H560GA01D	Murata
C5	0.1 $\mu$ F Chip Capacitor	GRM188R71H104KA93D	Murata
L1	1 nH Chip Inductor	0402CS-1N0XJLW	Coilcraft
L2	2.7 nH Chip Inductor	LQG15HS2N7S02	Murata
L3	82 nH Chip Inductor	0603CS-82NX_LW	Coilcraft
PCB	Isola IS680-338, 0.010", $\epsilon_r = 3.38$	M31382	MTL

### 50 OHM APPLICATION CIRCUIT: 3600–3800 MHz



PCB actual size: 1" × 1".

Note: Components L2 and C3 are connected together in series.

**Figure 44. MMG20241HT1 Test Circuit Component Layout**

**Table 13. MMG20241HT1 Test Circuit Component Designations and Values**

Part	Description	Part Number	Manufacturer
C1	0.6 pF Chip Capacitor	RVEVK105CH0R6BW-F	Taiyo Yuden
C2	1 pF Chip Capacitor	GJM1555C1H1R0CB01D	Murata
C3	0.01 $\mu$ F Chip Capacitor	GRM155R71E103KA01D	Murata
C4	56 pF Chip Capacitor	GRM188RC1H560GA01D	Murata
C5	0.1 $\mu$ F Chip Capacitor	GRM188R71H104KA93D	Murata
L1	1 nH Chip Inductor	0402CS-1N0XJLW	Coilcraft
L2	2.7 nH Chip Inductor	LQG15HS2N7S02	Murata
L3	82 nH Chip Inductor	0603CS-82NX_LW	Coilcraft
PCB	Isola IS680-338, 0.010", $\epsilon_r = 3.38$	M31382	MTL

(Test Circuit Component Designations and Values table repeated for reference.)

50 OHM TYPICAL CHARACTERISTICS: 3600–3800 MHz

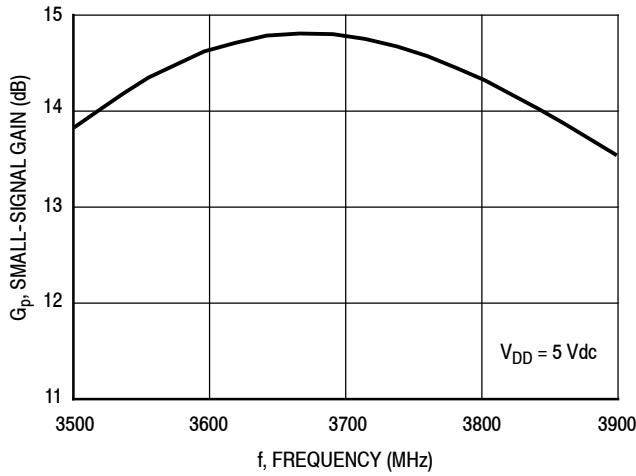


Figure 45. Small-Signal Gain (S21) versus Frequency

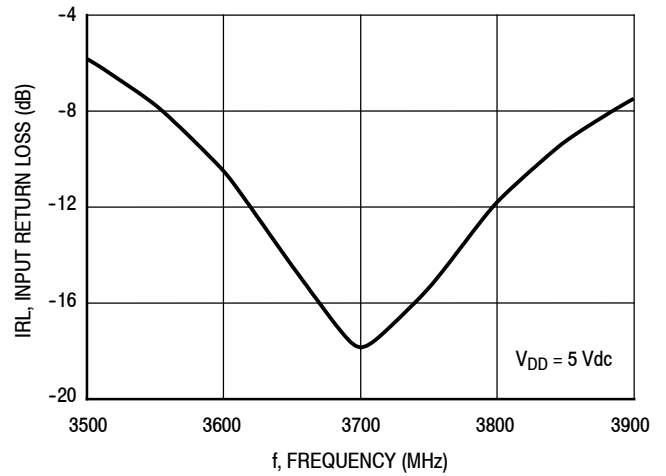


Figure 46. Input Return Loss (S11) versus Frequency

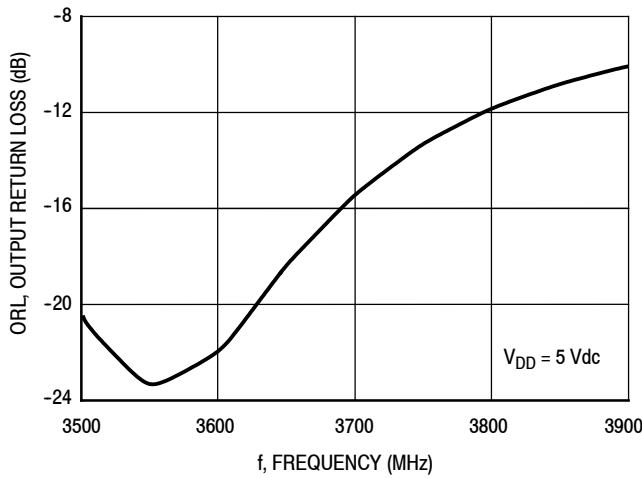


Figure 47. Output Return Loss (S22) versus Frequency

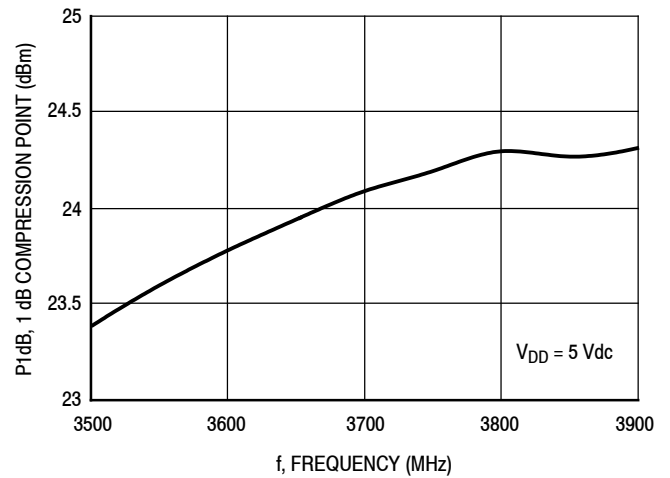


Figure 48. P1dB versus Frequency

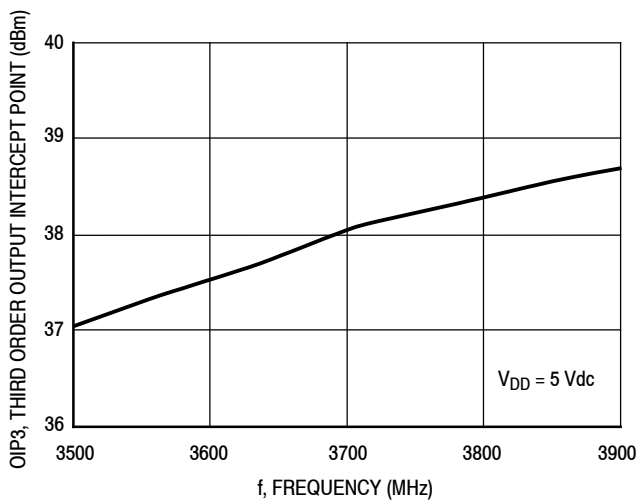


Figure 49. Third Order Output Intercept Point versus Frequency

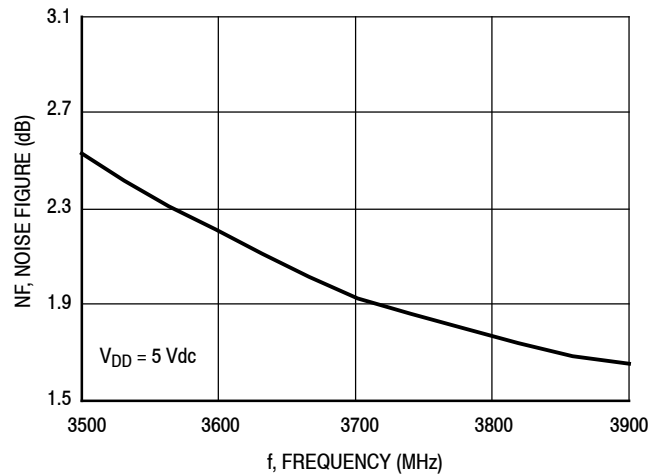


Figure 50. Noise Figure versus Frequency

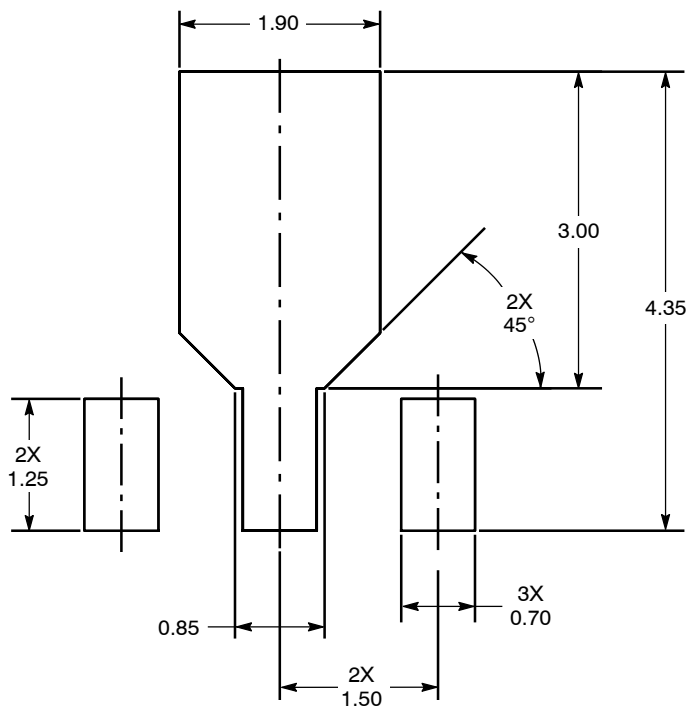


Figure 51. PCB Pad Layout for SOT-89A

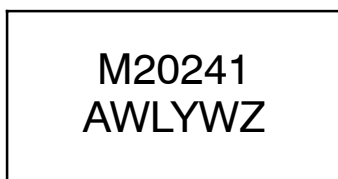
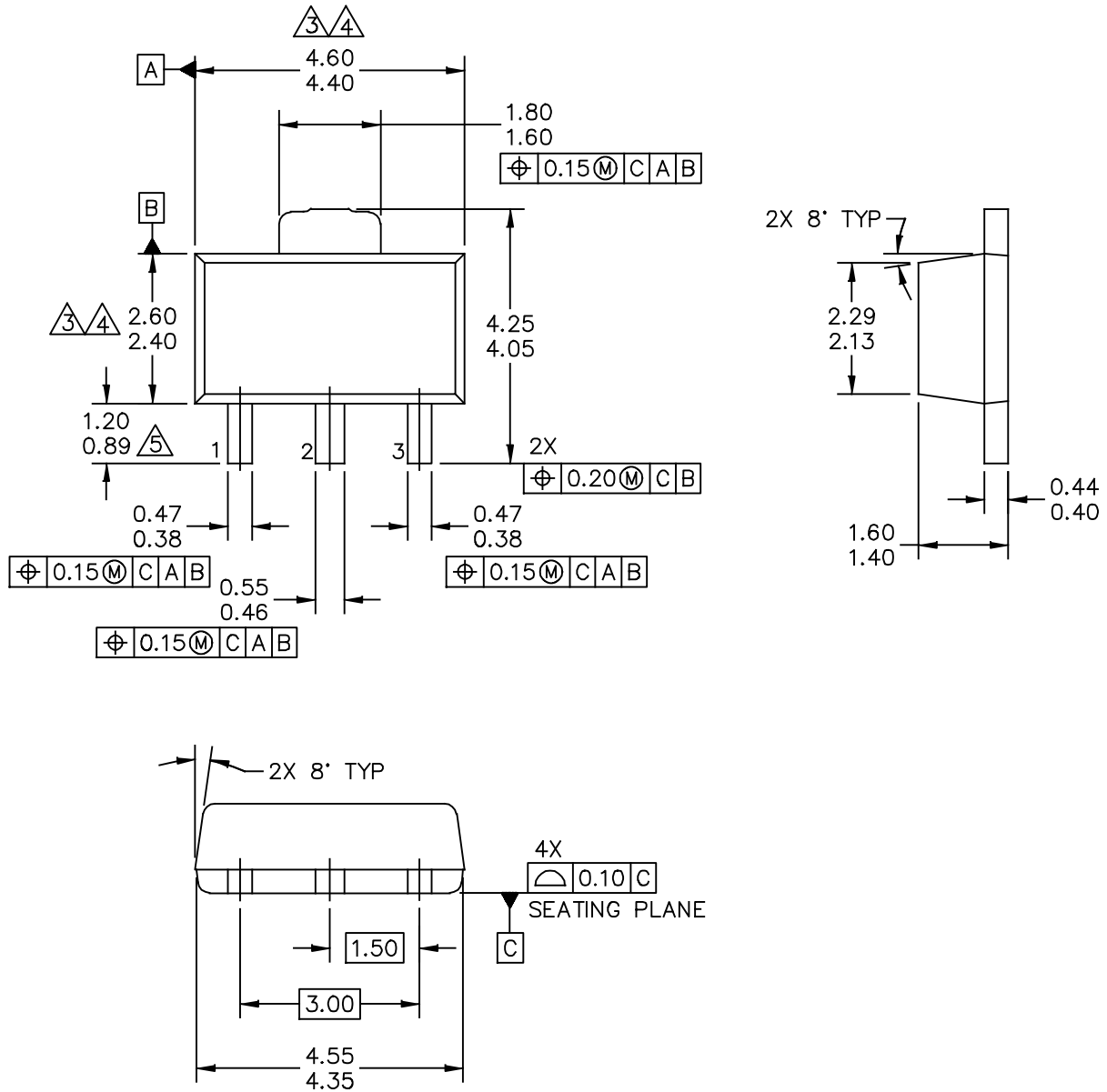
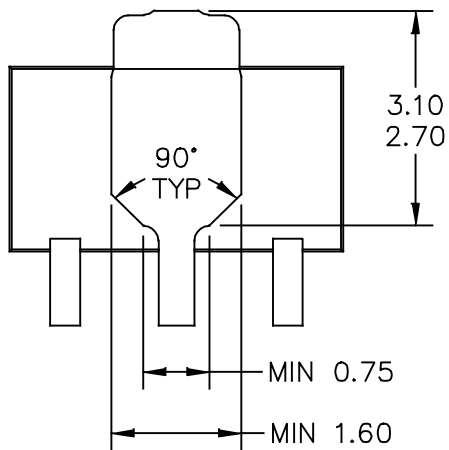


Figure 52. Product Marking

PACKAGE DIMENSIONS



© FREESCALE SEMICONDUCTOR, INC. ALL RIGHTS RESERVED.	MECHANICAL OUTLINE	PRINT VERSION NOT TO SCALE	
TITLE: SOT-89A, 3 LEAD, 4.5 X 2.5 PKG, 1.5 MM PITCH	DOCUMENT NO: 98ASA00241D	REV: 0	
	CASE NUMBER: 2142-01	15 JUL 2010	
	STANDARD: NON-JEDEC		



BOTTOM VIEW

© FREESCALE SEMICONDUCTOR, INC. ALL RIGHTS RESERVED.	MECHANICAL OUTLINE	PRINT VERSION NOT TO SCALE	
TITLE: SOT-89A, 3 LEAD, 4.5 X 2.5 PKG, 1.5 MM PITCH	DOCUMENT NO: 98ASA00241D	REV: 0	
	CASE NUMBER: 2142-01	15 JUL 2010	
	STANDARD: NON-JEDEC		



NOTES:

- 1. DIMENSIONING AND TOLERANCING PER ASME Y14.5M – 1994.
- 2. ALL DIMENSIONS ARE IN MILLIMETERS.

3. DIMENSIONS DOES NOT INCLUDE MOLD FLASH. PROTRUSIONS OR GATE BURRS. MOLD FLASH, PROTRUSIONS OR GATE BURRS SHALL NOT EXCEED 0.5 MM PER END. DIMENSION DOES NOT INCLUDE INTERLEAD FLASH OR PROTRUSION. INTERLEAD FLASH OR PROTRUSION SHALL NOT EXCEED 0.5 MM PER SIDE.

4. DIMENSION ARE DETERMINED AT THE OUTMOST EXTREMES OF THE PLASTIC BODY EXCLUSIVE OF MOLD FLASH, TIE BAR BURRS, GATE BURRS AND INTERLEAD FLASH, BUT INCLUDING ANY MISMATCH BETWEEN THE TOP AND BOTTOM OF THE PLASTIC BODY.

5. TERMINAL NUMBERS ARE SHOWN FOR REFERENCE ONLY.

© FREESCALE SEMICONDUCTOR, INC. ALL RIGHTS RESERVED.	MECHANICAL OUTLINE	PRINT VERSION NOT TO SCALE	
TITLE: SOT-89A, 3 LEAD, 4.5 X 2.5 PKG, 1.5 MM PITCH	DOCUMENT NO: 98ASA00241D	REV: 0	
	CASE NUMBER: 2142-01	15 JUL 2010	
	STANDARD: NON-JEDEC		

Refer to the following resources to aid your design process.

**Application Notes**

- AN1955: Thermal Measurement Methodology of RF Power Amplifiers

**Software**

- .s2p File

**Development Tools**

- Printed Circuit Boards

For Software and Tools, do a Part Number search at <http://www.freescale.com>, and select the “Part Number” link. Go to Software & Tools on the part’s Product Summary page to download the respective tool.

**FAILURE ANALYSIS**

At this time, because of the physical characteristics of the part, failure analysis is limited to electrical signature analysis. In cases where Freescale is contractually obligated to perform failure analysis (FA) services, full FA may be performed by third party vendors with moderate success. For updates contact your local Freescale Sales Office.

**REVISION HISTORY**

The following table summarizes revisions to this document.

<b>Revision</b>	<b>Date</b>	<b>Description</b>
0	Apr. 2014	<ul style="list-style-type: none"> <li>• Initial Release of Data Sheet</li> </ul>
1	July 2014	<ul style="list-style-type: none"> <li>• Table 2, Maximum Ratings: updated Junction Temperature from 150°C to 175°C to reflect recent test results of the device, p. 1</li> <li>• Fig. 2, Test Circuit Schematic for 2110–2170 MHz: changed pin 4 to pin 2 to reflect correct pin numbers, p. 3</li> <li>• Added application circuit for 1805–2025 MHz as follows: schematic, component designations and values, component layout, and typical characteristic performance graphs, pp. 10–12</li> <li>• Added application circuit for 2300–2400 MHz as follows: schematic, component designations and values, component layout, and typical characteristic performance graphs, pp. 13–15</li> <li>• Added application circuit for 2570–2620 MHz as follows: schematic, component designations and values, component layout, and typical characteristic performance graphs, pp. 16–18</li> </ul>
2	Sept. 2014	<ul style="list-style-type: none"> <li>• Typical Performance table: added 3700 MHz performance values, p. 1</li> <li>• Added application circuit for 3600–3800 MHz as follows: schematic, component designations and values, component layout, and typical characteristic performance graphs, pp. 19–21</li> </ul>

***How to Reach Us:***

**Home Page:**  
[freescale.com](http://freescale.com)

**Web Support:**  
[freescale.com/support](http://freescale.com/support)

Information in this document is provided solely to enable system and software implementers to use Freescale products. There are no express or implied copyright licenses granted hereunder to design or fabricate any integrated circuits based on the information in this document.

Freescale reserves the right to make changes without further notice to any products herein. Freescale makes no warranty, representation, or guarantee regarding the suitability of its products for any particular purpose, nor does Freescale assume any liability arising out of the application or use of any product or circuit, and specifically disclaims any and all liability, including without limitation consequential or incidental damages. "Typical" parameters that may be provided in Freescale data sheets and/or specifications can and do vary in different applications, and actual performance may vary over time. All operating parameters, including "typicals," must be validated for each customer application by customer's technical experts. Freescale does not convey any license under its patent rights nor the rights of others. Freescale sells products pursuant to standard terms and conditions of sale, which can be found at the following address: [freescale.com/SalesTermsandConditions](http://freescale.com/SalesTermsandConditions).

Freescale and the Freescale logo are trademarks of Freescale Semiconductor, Inc., Reg. U.S. Pat. & Tm. Off. All other product or service names are the property of their respective owners.

© 2014 Freescale Semiconductor, Inc.

# Mouser Electronics

Authorized Distributor

Click to View Pricing, Inventory, Delivery & Lifecycle Information:

[Freescale Semiconductor:](#)

[MMG20241HT1](#)