

BCX17LT1G, PNP BCX18LT1G, PNP BCX19LT1G, NPN SBCX19LT1G, NPN



ON Semiconductor®

<http://onsemi.com>

General Purpose Transistors

Voltage and Current are Negative for PNP Transistors

Features

- S and NSV Prefix for Automotive and Other Applications Requiring Unique Site and Control Change Requirements; AEC-Q101 Qualified and PPAP Capable
- These Devices are Pb-Free, Halogen Free/BFR Free and are RoHS Compliant*

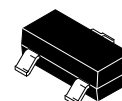

SOT-23
(TO-236)
CASE 318-08
STYLE 6

MAXIMUM RATINGS

Rating	Symbol	Value	Unit
Collector – Emitter Voltage BCX17, BCX19 BCX18	V_{CEO}	45 25	Vdc
Collector – Base Voltage BCX17, BCX19 BCX18	V_{CBO}	50 30	Vdc
Emitter – Base Voltage	V_{EBO}	5.0	Vdc
Collector Current – Continuous	I_C	500	mAdc

THERMAL CHARACTERISTICS

Characteristic	Symbol	Max	Unit
Total Device Dissipation FR-5 Board (Note 1), $T_A = 25^\circ\text{C}$ Derate above 25°C	P_D	225 1.8	mW mW/ $^\circ\text{C}$
Thermal Resistance, Junction-to-Ambient	$R_{\theta JA}$	556	$^\circ\text{C}/\text{W}$
Total Device Dissipation Alumina Substrate, (Note 2) $T_A = 25^\circ\text{C}$ Derate above 25°C	P_D	300 2.4	mW mW/ $^\circ\text{C}$
Thermal Resistance, Junction-to-Ambient	$R_{\theta JA}$	417	$^\circ\text{C}/\text{W}$
Junction and Storage Temperature	T_J, T_{stg}	-55 to +150	$^\circ\text{C}$

Stresses exceeding those listed in the Maximum Ratings table may damage the device. If any of these limits are exceeded, device functionality should not be assumed, damage may occur and reliability may be affected.

1. FR-5 = $1.0 \times 0.75 \times 0.062$ in.
2. Alumina = $0.4 \times 0.3 \times 0.024$ in 99.5% alumina.

*For additional information on our Pb-Free strategy and soldering details, please download the ON Semiconductor Soldering and Mounting Techniques Reference Manual, SOLDERRM/D.

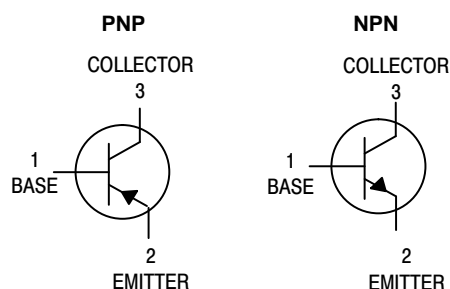

MARKING DIAGRAM

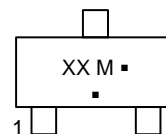

XX = T1, T2 or U1
M = Date Code*
▪ = Pb-Free Package

(Note: Microdot may be in either location)

*Date Code orientation and/or overbar may vary depending upon manufacturing location.

ORDERING INFORMATION

See detailed ordering and shipping information in the package dimensions section on page 2 of this data sheet.

BCX17LT1G, PNP BCX18LT1G, PNP BCX19LT1G, NPN SBCX19LT1G, NPN

ELECTRICAL CHARACTERISTICS (T_A = 25°C unless otherwise noted)

Characteristic	Symbol	Min	Typ	Max	Unit
OFF CHARACTERISTICS					
Collector–Emitter Breakdown Voltage (I _C = 10 mAdc, I _B = 0) BCX17, BCX19, SBCX19 BCX18	V _{(BR)CEO}	45 25	– –	– –	Vdc
Collector–Emitter Breakdown Voltage (I _C = 10 μAdc, I _C = 0) BCX17, BCX19, SBCX19 BCX18	V _{(BR)CES}	50 30	– –	– –	Vdc
Collector Cutoff Current (V _{CB} = 20 Vdc, I _E = 0) (V _{CB} = 20 Vdc, I _E = 0, T _A = 150°C)	I _{CBO}	– –	– –	100 5.0	nAdc μAdc
Emitter Cutoff Current (V _{EB} = 5.0 Vdc, I _C = 0)	I _{EBO}	–	–	10	μAdc

ON CHARACTERISTICS

DC Current Gain (I _C = 100 mAdc, V _{CE} = 1.0 Vdc) (I _C = 300 mAdc, V _{CE} = 1.0 Vdc) (I _C = 500 mAdc, V _{CE} = 1.0 Vdc)	h _{FE}	100 70 40	– – –	600 – –	–
Collector–Emitter Saturation Voltage (I _C = 500 mAdc, I _B = 50 mAdc)	V _{CE(sat)}	–	–	0.62	Vdc
Base–Emitter On Voltage (I _C = 500 mAdc, V _{CE} = 1.0 Vdc)	V _{BE(on)}	–	–	1.2	Vdc

ORDERING INFORMATION

Device	Specific Marking	Package	Shipping [†]
BCX17LT1G	T1	SOT–23 (Pb–Free)	3,000 / Tape & Reel
NSVBCX17LT1G*	T1	SOT–23 (Pb–Free)	3,000 / Tape & Reel
BCX18LT1G	T2	SOT–23 (Pb–Free)	3,000 / Tape & Reel
BCX19LT1G	U1	SOT–23 (Pb–Free)	3,000 / Tape & Reel
SBCX19LT1G*	U1	SOT–23 (Pb–Free)	3,000 / Tape & Reel

[†]For information on tape and reel specifications, including part orientation and tape sizes, please refer to our Tape and Reel Packaging Specifications Brochure, BRD8011/D.

*S and NSV Prefix for Automotive and Other Applications Requiring Unique Site and Control Change Requirements; AEC–Q101 Qualified and PPAP Capable.

BCX17LT1G, PNP BCX18LT1G, PNP BCX19LT1G, NPN SBCX19LT1G, NPN

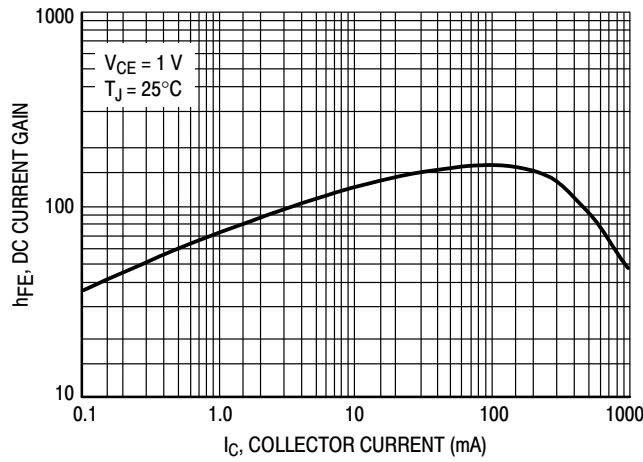

Figure 1. DC Current Gain

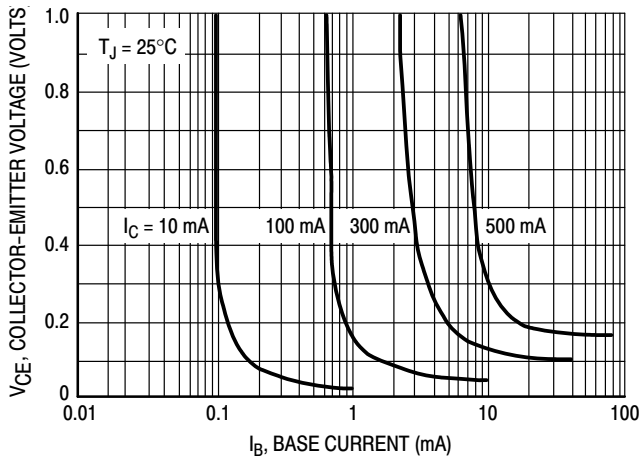

Figure 2. Saturation Region

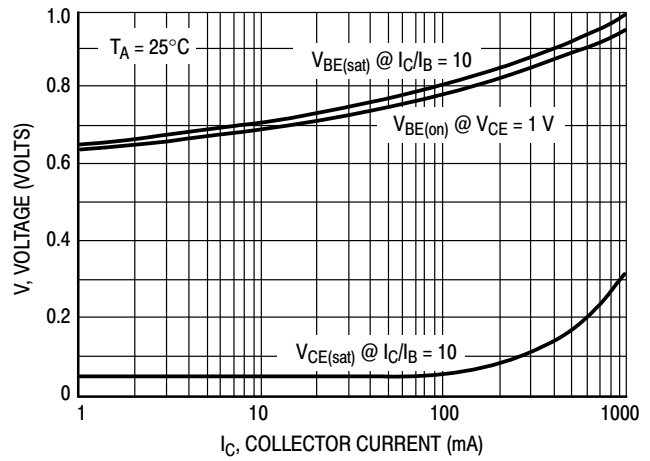

Figure 3. "On" Voltages

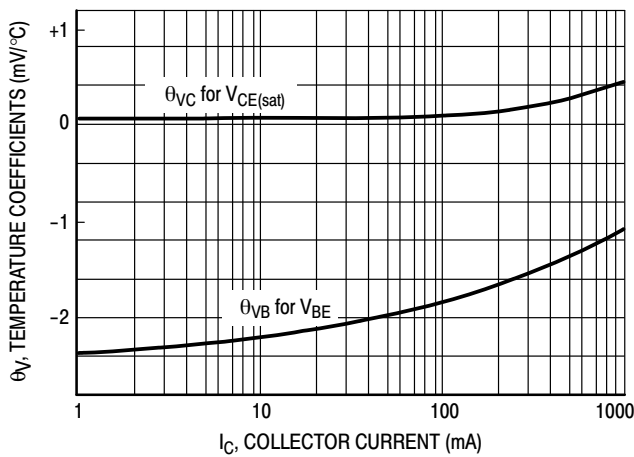

Figure 4. Temperature Coefficients

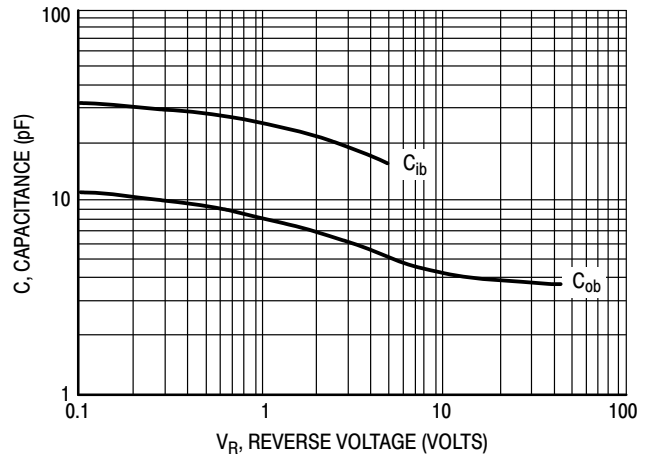
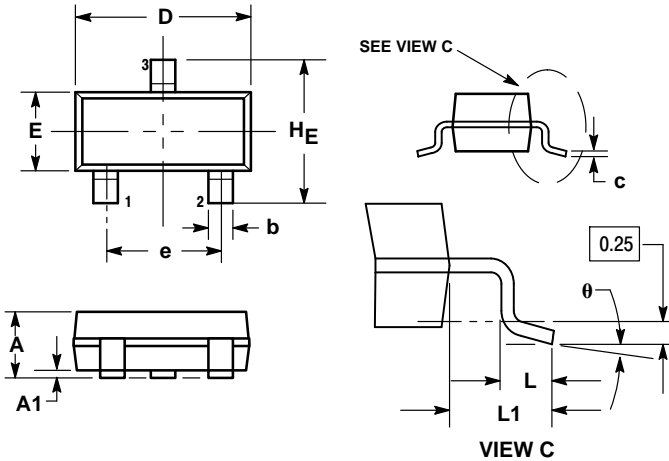

Figure 5. Capacitances

BCX17LT1G, PNP BCX18LT1G, PNP BCX19LT1G, NPN SBCX19LT1G, NPN

PACKAGE DIMENSIONS

SOT-23 (TO-236)
CASE 318-08
ISSUE AP



NOTES:

1. DIMENSIONING AND TOLERANCING PER ANSI Y14.5M, 1982.
2. CONTROLLING DIMENSION: INCH.
3. MAXIMUM LEAD THICKNESS INCLUDES LEAD FINISH THICKNESS. MINIMUM LEAD THICKNESS IS THE MINIMUM THICKNESS OF BASE MATERIAL.
4. DIMENSIONS D AND E DO NOT INCLUDE MOLD FLASH, PROTRUSIONS, OR GATE BURRS.

DIM	MILLIMETERS			INCHES		
	MIN	NOM	MAX	MIN	NOM	MAX
A	0.89	1.00	1.11	0.035	0.040	0.044
A1	0.01	0.06	0.10	0.001	0.002	0.004
b	0.37	0.44	0.50	0.015	0.018	0.020
c	0.09	0.13	0.18	0.003	0.005	0.007
D	2.80	2.90	3.04	0.110	0.114	0.120
E	1.20	1.30	1.40	0.047	0.051	0.055
e	1.78	1.90	2.04	0.070	0.075	0.081
L	0.10	0.20	0.30	0.004	0.008	0.012
L1	0.35	0.54	0.69	0.014	0.021	0.029
HE	2.10	2.40	2.64	0.083	0.094	0.104
θ	0°	—	10°	0°	—	10°

STYLE 6:

1. BASE
2. EMITTER
3. COLLECTOR

SOLDERING FOOTPRINT

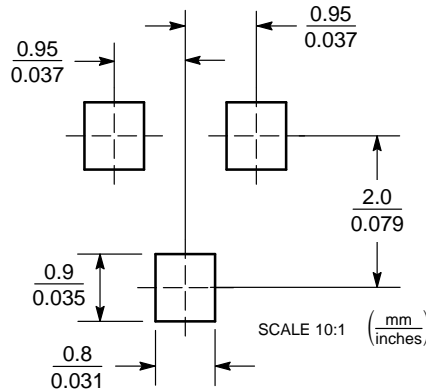

ON Semiconductor and are registered trademarks of Semiconductor Components Industries, LLC (SCILLC). SCILLC reserves the right to make changes without further notice to any products herein. SCILLC makes no warranty, representation or guarantee regarding the suitability of its products for any particular purpose, nor does SCILLC assume any liability arising out of the application or use of any product or circuit, and specifically disclaims any and all liability, including without limitation special, consequential or incidental damages. "Typical" parameters which may be provided in SCILLC data sheets and/or specifications can and do vary in different applications and actual performance may vary over time. All operating parameters, including "Typicals" must be validated for each customer application by customer's technical experts. SCILLC does not convey any license under its patent rights nor the rights of others. SCILLC products are not designed, intended, or authorized for use as components in systems intended for surgical implant into the body, or other applications intended to support or sustain life, or for any other application in which the failure of the SCILLC product could create a situation where personal injury or death may occur. Should Buyer purchase or use SCILLC products for any such unintended or unauthorized application, Buyer shall indemnify and hold SCILLC and its officers, employees, subsidiaries, affiliates, and distributors harmless against all claims, costs, damages, and expenses, and reasonable attorney fees arising out of, directly or indirectly, any claim of personal injury or death associated with such unintended or unauthorized use, even if such claim alleges that SCILLC was negligent regarding the design or manufacture of the part. SCILLC is an Equal Opportunity/Affirmative Action Employer. This literature is subject to all applicable copyright laws and is not for resale in any manner.

PUBLICATION ORDERING INFORMATION

LITERATURE FULFILLMENT:
Literature Distribution Center for ON Semiconductor
P.O. Box 5163, Denver, Colorado 80217 USA
Phone: 303-675-2175 or 800-344-3860 Toll Free USA/Canada
Fax: 303-675-2176 or 800-344-3867 Toll Free USA/Canada
Email: orderlit@onsemi.com

N. American Technical Support: 800-282-9855 Toll Free
USA/Canada
Europe, Middle East and Africa Technical Support:
Phone: 421 33 790 2910
Japan Customer Focus Center
Phone: 81-3-5817-1050

ON Semiconductor Website: www.onsemi.com

Order Literature: <http://www.onsemi.com/orderlit>

For additional information, please contact your local Sales Representative

Mouser Electronics

Authorized Distributor

Click to View Pricing, Inventory, Delivery & Lifecycle Information:

[ON Semiconductor:](#)

[BCX17LT1G](#) [BCX19LT1G](#) [SBCX19LT1G](#) [NSVBCX17LT1G](#)