

MJD31 (NPN), MJD32 (PNP)

Complementary Power Transistors

DPAK For Surface Mount Applications

Designed for general purpose amplifier and low speed switching applications.

Features

- Lead Formed for Surface Mount Applications in Plastic Sleeves
- Straight Lead Version in Plastic Sleeves (“1” Suffix)
- Lead Formed Version in 16 mm Tape and Reel (“T4” Suffix)
- Electrically Similar to Popular TIP31 and TIP32 Series
- Epoxy Meets UL 94, V-0 @ 0.125 in
- NJV Prefix for Automotive and Other Applications Requiring Unique Site and Control Change Requirements; AEC-Q101 Qualified and PPAP Capable
- These Devices are Pb-Free and are RoHS Compliant

MAXIMUM RATINGS

| Rating | Symbol | Max | Unit |
|------------------------------------------------------------------------------------------|----------------|----------------|--------------------------|
| Collector-Emitter Voltage MJD31, MJD32 MJD31C, MJD32C | V_{CEO} | 40 100 | Vdc |
| Collector-Base Voltage MJD31, MJD32 MJD31C, MJD32C | V_{CB} | 40 100 | Vdc |
| Emitter-Base Voltage | V_{EB} | 5.0 | Vdc |
| Collector Current – Continuous | I_C | 3.0 | Adc |
| Collector Current – Peak | I_{CM} | 5.0 | Adc |
| Base Current | I_B | 1.0 | Adc |
| Total Power Dissipation @ $T_C = 25^\circ\text{C}$ Derate above 25°C | P_D | 15 0.12 | W W/ $^\circ\text{C}$ |
| Total Power Dissipation @ $T_A = 25^\circ\text{C}$ Derate above 25°C | P_D | 1.56 0.012 | W W/ $^\circ\text{C}$ |
| Operating and Storage Junction Temperature Range | T_J, T_{stg} | -65 to +150 | $^\circ\text{C}$ |
| ESD – Human Body Model | HBM | 3B | V |
| ESD – Machine Model | MM | C | V |

Stresses exceeding those listed in the Maximum Ratings table may damage the device. If any of these limits are exceeded, device functionality should not be assumed, damage may occur and reliability may be affected.

THERMAL CHARACTERISTICS

| Characteristic | Symbol | Max | Unit |
|------------------------------------------|-----------------|-----|--------------------|
| Thermal Resistance, Junction-to-Case | $R_{\theta JC}$ | 8.3 | $^\circ\text{C/W}$ |
| Thermal Resistance, Junction-to-Ambient* | $R_{\theta JA}$ | 80 | $^\circ\text{C/W}$ |
| Lead Temperature for Soldering Purposes | T_L | 260 | $^\circ\text{C}$ |

*These ratings are applicable when surface mounted on the minimum pad sizes recommended.



ON Semiconductor®

www.onsemi.com

**SILICON
POWER TRANSISTORS
3 AMPERES
40 AND 100 VOLTS
15 WATTS**

COMPLEMENTARY

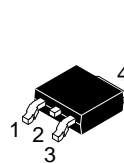
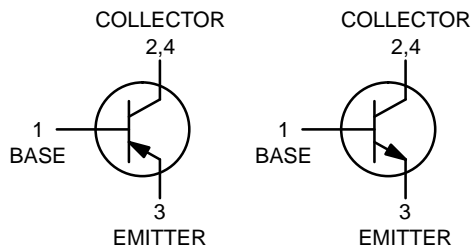

**DPAK
CASE 369C
STYLE 1**

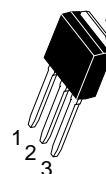

**IPAK
CASE 369D
STYLE 1**

MARKING DIAGRAMS

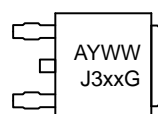

DPAK

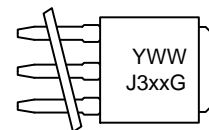

IPAK

A = Site Code
Y = Year
WW = Work Week
xx = 1, 1C, 2, or 2C
G = Pb-Free Package

ORDERING INFORMATION

See detailed ordering and shipping information in the package dimensions section on page 8 of this data sheet.

MJD31 (NPN), MJD32 (PNP)

ELECTRICAL CHARACTERISTICS (T_C = 25°C unless otherwise noted)

| Characteristic | Symbol | Min | Max | Unit |
|----------------|--------|-----|-----|------|
|----------------|--------|-----|-----|------|

OFF CHARACTERISTICS

| | | | | |
|------------------------------------------------------------------------------------------------------------------------------------------------------------------------------------------|-----------------------|-----------|----------|------------------|
| Collector–Emitter Sustaining Voltage (Note 1) (I _C = 30 mA _{dc} , I _B = 0) MJD31, MJD32 MJD31C, MJD32C | V _{CEO(sus)} | 40 100 | – – | V _{dc} |
| Collector Cutoff Current (V _{CE} = 40 V _{dc} , I _B = 0) MJD31, MJD32 (V _{CE} = 60 V _{dc} , I _B = 0) MJD31C, MJD32C | I _{CEO} | – – | 50 50 | μA _{dc} |
| Collector Cutoff Current (V _{CE} = Rated V _{CEO} , V _{EB} = 0) | I _{CES} | – | 20 | μA _{dc} |
| Emitter Cutoff Current (V _{BE} = 5 V _{dc} , I _C = 0) | I _{EBO} | – | 1 | mA _{dc} |

ON CHARACTERISTICS (Note 1)

| | | | | |
|-------------------------------------------------------------------------------------------------------------------------------------------------------------------------------|----------------------|----------|---------|-----------------|
| DC Current Gain (I _C = 1 A _{dc} , V _{CE} = 4 V _{dc}) (I _C = 3 A _{dc} , V _{CE} = 4 V _{dc}) | h _{FE} | 25 10 | – 50 | |
| Collector–Emitter Saturation Voltage (I _C = 3 A _{dc} , I _B = 375 mA _{dc}) | V _{CE(sat)} | – | 1.2 | V _{dc} |
| Base–Emitter On Voltage (I _C = 3 A _{dc} , V _{CE} = 4 V _{dc}) | V _{BE(on)} | – | 1.8 | V _{dc} |

DYNAMIC CHARACTERISTICS

| | | | | |
|---------------------------------------------------------------------------------------------------------------------------------------------------------|-----------------|----|---|-----|
| Current Gain – Bandwidth Product (Note 2) (I _C = 500 mA _{dc} , V _{CE} = 10 V _{dc} , f _{test} = 1 MHz) | f _T | 3 | – | MHz |
| Small–Signal Current Gain (I _C = 0.5 A _{dc} , V _{CE} = 10 V _{dc} , f = 1 kHz) | h _{fe} | 20 | – | |

1. Pulse Test: Pulse Width ≤ 300 μs, Duty Cycle ≤ 2%.
2. f_T = |h_{fe}| • f_{test}.

MJD31 (NPN), MJD32 (PNP)

TYPICAL CHARACTERISTICS



Figure 1. Power Derating

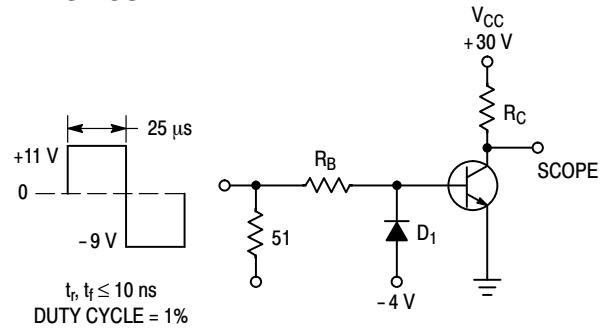

R_B and R_C VARIED TO OBTAIN DESIRED CURRENT LEVELS
 D_1 MUST BE FAST RECOVERY TYPE, e.g.:
 1N5825 USED ABOVE $I_B \approx 100$ mA
 MSD6100 USED BELOW $I_B \approx 100$ mA
 REVERSE ALL POLARITIES FOR PNP.

Figure 2. Switching Time Test Circuit



Figure 3. Turn-On Time



Figure 4. Turn-Off Time

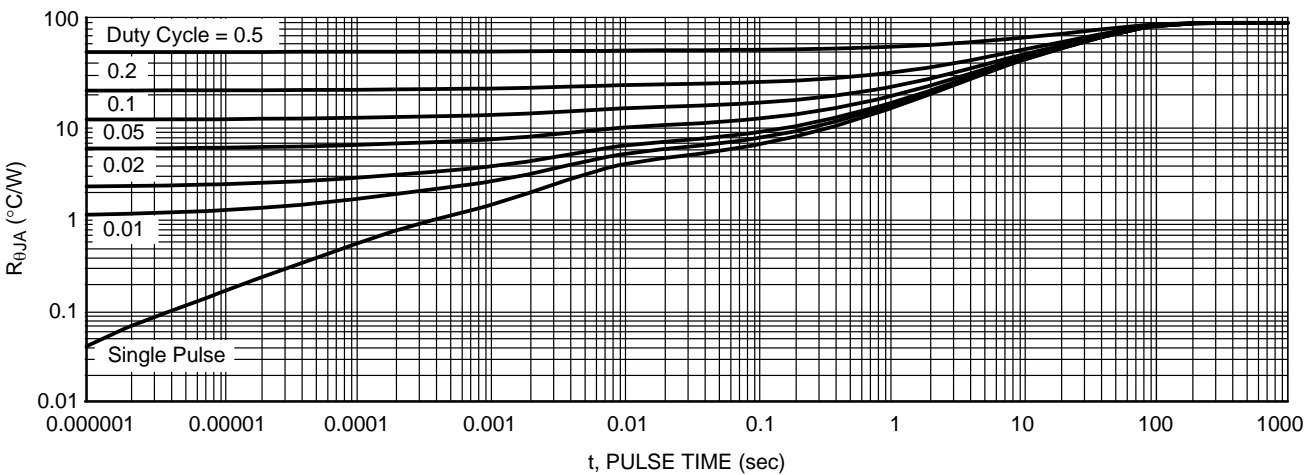

Figure 5. Thermal Response

MJD31 (NPN), MJD32 (PNP)

TYPICAL CHARACTERISTICS – MJD31, MJD31C (NPN)

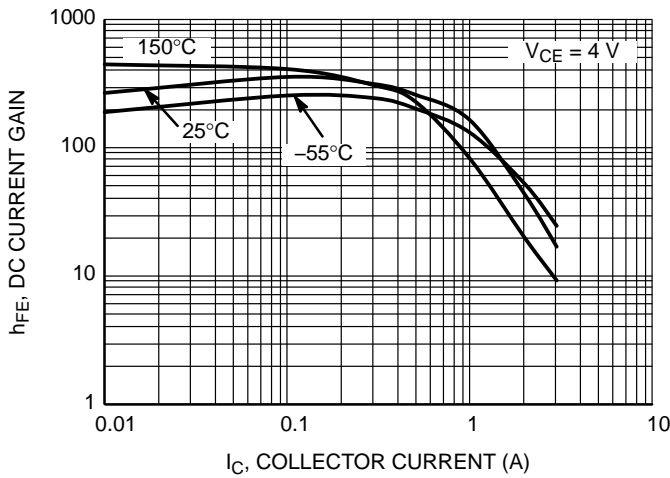

Figure 6. DC Current Gain at $V_{CE} = 4\text{ V}$

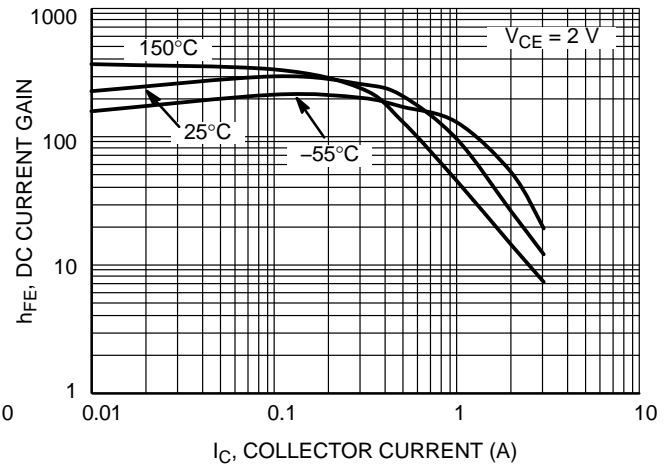

Figure 7. DC Current Gain at $V_{CE} = 2\text{ V}$

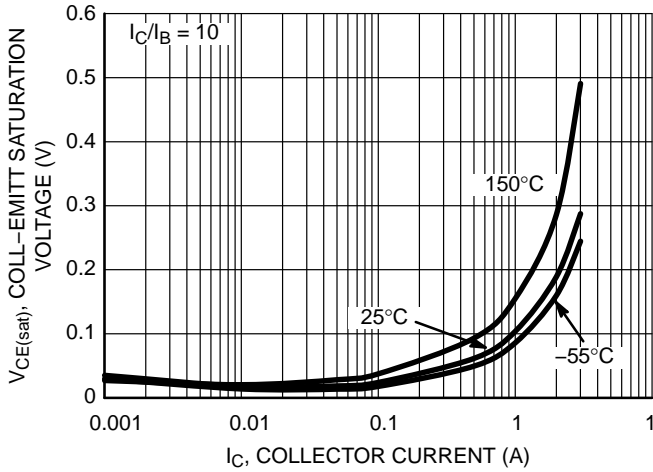

Figure 8. Collector-Emitter Saturation Voltage

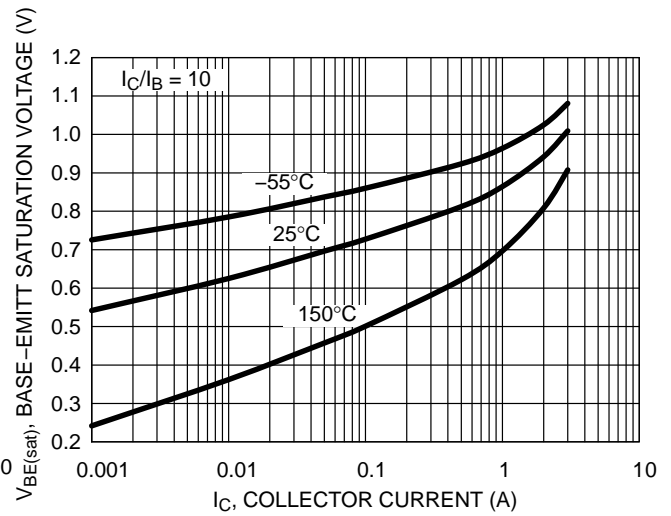

Figure 9. Base-Emitter Saturation Voltage

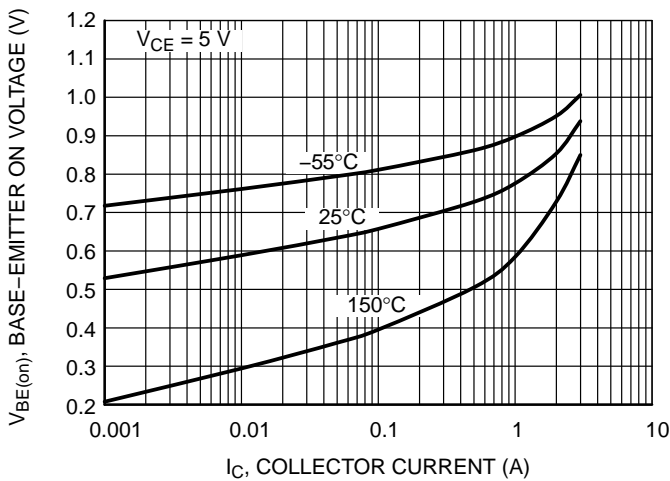

Figure 10. Base-Emitter "On" Voltage

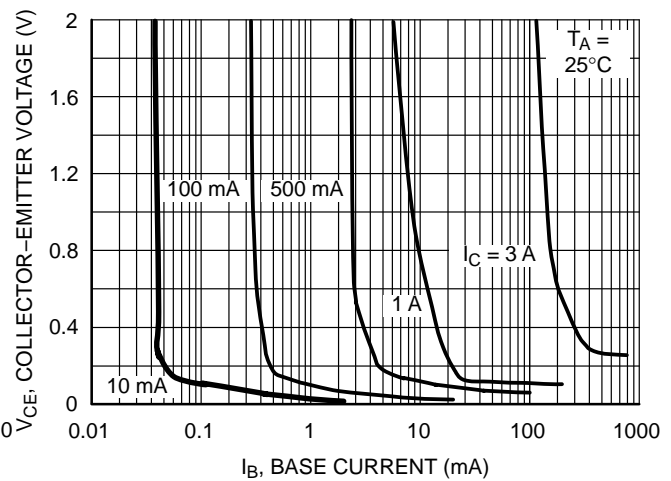

Figure 11. Collector Saturation Region

MJD31 (NPN), MJD32 (PNP)

TYPICAL CHARACTERISTICS – MJD31, MJD31C (NPN)

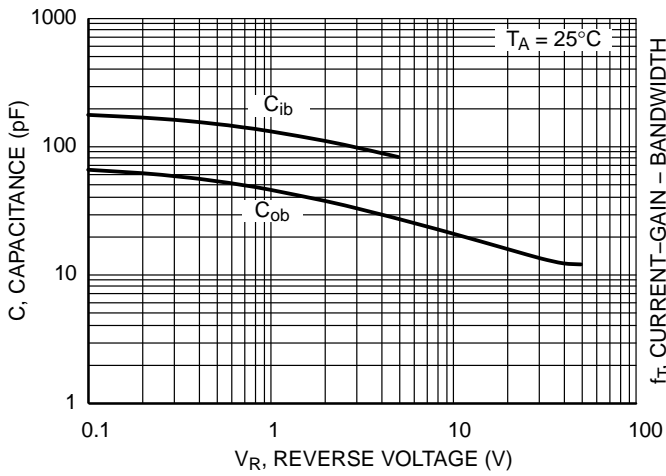

Figure 12. Capacitance

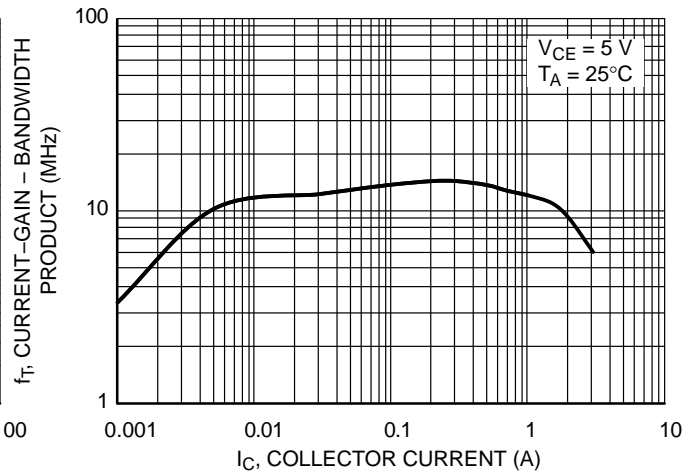

Figure 13. Current-Gain-Bandwidth Product

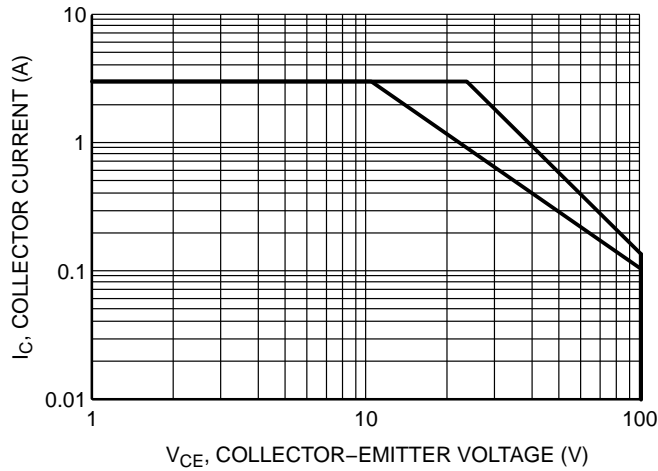

Figure 14. Safe Operating Area

MJD31 (NPN), MJD32 (PNP)

TYPICAL CHARACTERISTICS – MJD32, MJD32C (PNP)

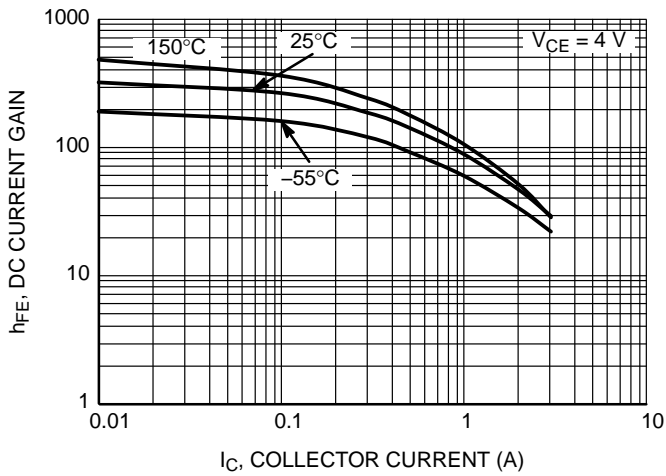

Figure 15. DC Current Gain at $V_{CE} = 4\text{ V}$

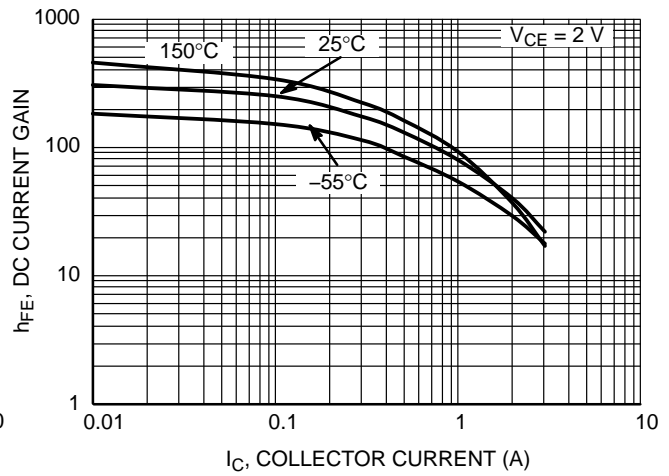

Figure 16. DC Current Gain at $V_{CE} = 2\text{ V}$

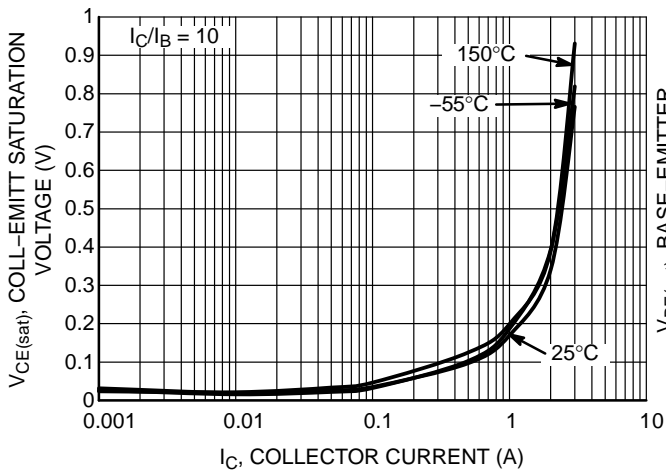

Figure 17. Collector-Emitter Saturation Voltage

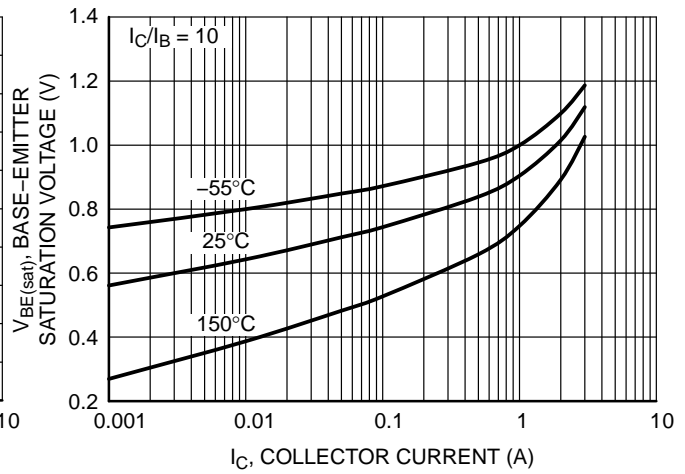

Figure 18. Base-Emitter Saturation Voltage

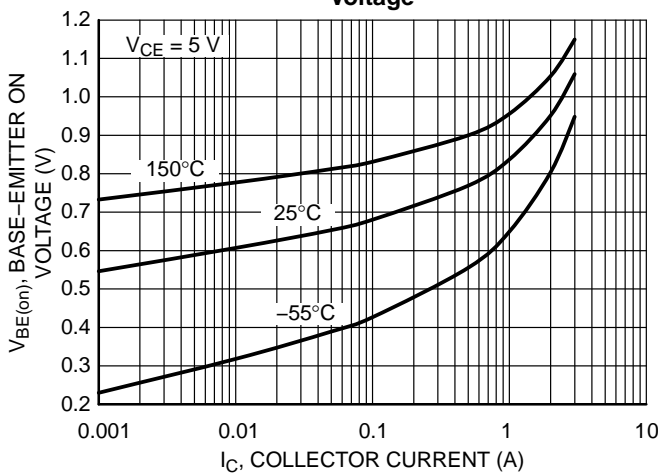

Figure 19. Base-Emitter "On" Voltage

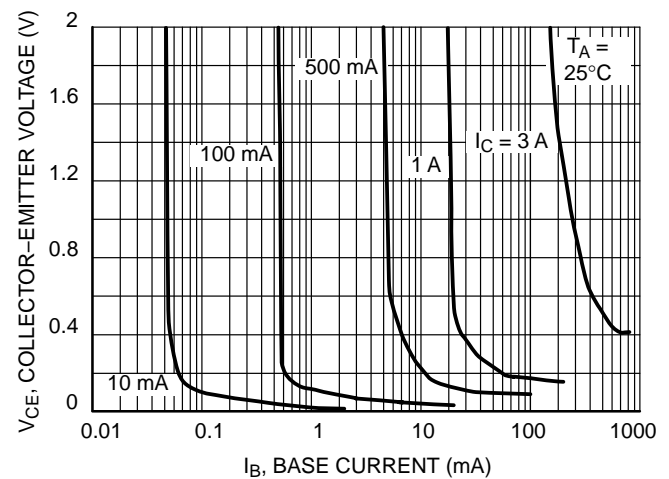

Figure 20. Collector Saturation Region

MJD31 (NPN), MJD32 (PNP)

TYPICAL CHARACTERISTICS

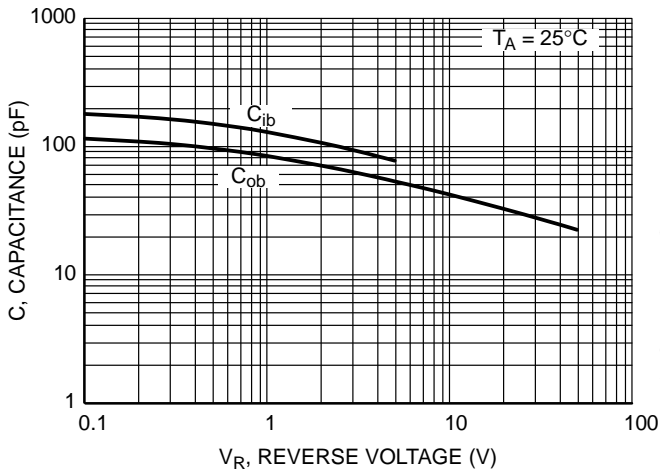

Figure 21. Capacitance

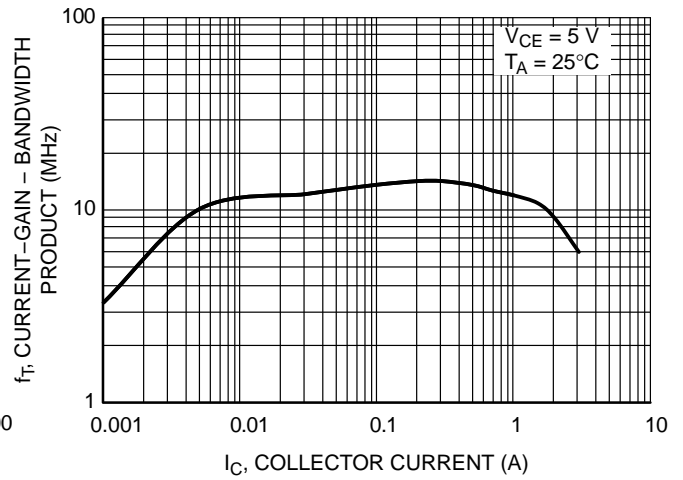

Figure 22. Current-Gain-Bandwidth Product

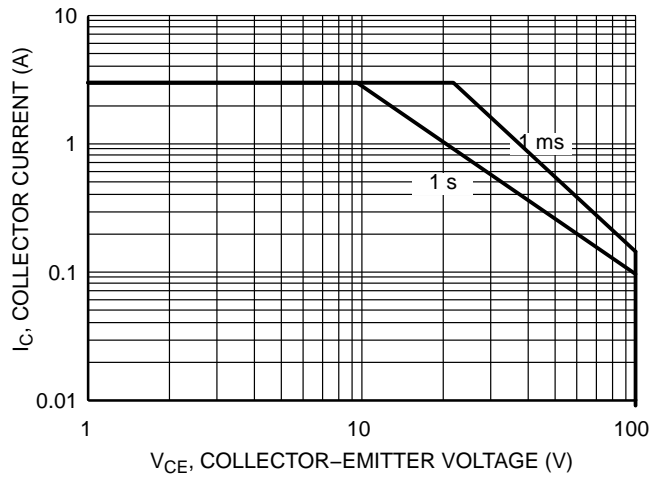

Figure 23. Safe Operating Area

MJD31 (NPN), MJD32 (PNP)

ORDERING INFORMATION

| Device | Package Type | Package | Shipping [†] |
|---------------|-------------------|---------|-----------------------|
| MJD31CG | DPAK (Pb-Free) | 369C | 75 Units / Rail |
| NJVMJD31CG* | DPAK (Pb-Free) | 369C | 75 Units / Rail |
| MJD31C1G | IPAK (Pb-Free) | 369D | 75 Units / Rail |
| MJD31CRLG | DPAK (Pb-Free) | 369C | 1,800 / Tape & Reel |
| NJVMJD31CRLG* | DPAK (Pb-Free) | 369C | 1,800 / Tape & Reel |
| MJD31CT4G | DPAK (Pb-Free) | 369C | 2,500 / Tape & Reel |
| NJVMJD31CT4G* | DPAK (Pb-Free) | 369C | 2,500 / Tape & Reel |
| MJD31T4G | DPAK (Pb-Free) | 369C | 2,500 / Tape & Reel |
| NJVMJD31T4G* | DPAK (Pb-Free) | 369C | 2,500 / Tape & Reel |
| MJD32CG | DPAK (Pb-Free) | 369C | 75 Units / Rail |
| NJVMJD32CG* | DPAK (Pb-Free) | 369C | 75 Units / Rail |
| MJD32CRLG | DPAK (Pb-Free) | 369C | 1,800 / Tape & Reel |
| MJD32CT4G | DPAK (Pb-Free) | 369C | 2,500 / Tape & Reel |
| NJVMJD32CT4G* | DPAK (Pb-Free) | 369C | 2,500 / Tape & Reel |
| MJD32RLG | DPAK (Pb-Free) | 369C | 1,800 / Tape & Reel |
| MJD32T4G | DPAK (Pb-Free) | 369C | 2,500 / Tape & Reel |
| NJVMJD32T4G* | DPAK (Pb-Free) | 369C | 2,500 / Tape & Reel |

†For information on tape and reel specifications, including part orientation and tape sizes, please refer to our Tape and Reel Packaging Specifications Brochure, BRD8011/D.

*NJV Prefix for Automotive and Other Applications Requiring Unique Site and Control Change Requirements; AEC-Q101 Qualified and PPAP Capable.

MJD31 (NPN), MJD32 (PNP)

PACKAGE DIMENSIONS

DPAK CASE 369C ISSUE D

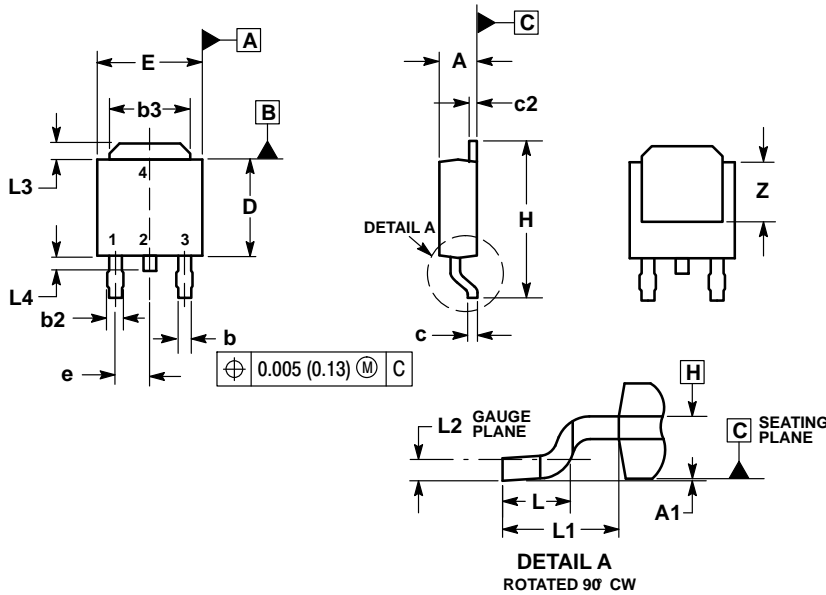

NOTES:

1. DIMENSIONING AND TOLERANCING PER ASME Y14.5M, 1994.
2. CONTROLLING DIMENSION: INCHES.
3. THERMAL PAD CONTOUR OPTIONAL WITHIN DIMENSIONS b3, L3 and Z.
4. DIMENSIONS D AND E DO NOT INCLUDE MOLD FLASH, PROTRUSIONS, OR BURRS. MOLD FLASH, PROTRUSIONS, OR GATE BURRS SHALL NOT EXCEED 0.006 INCHES PER SIDE.
5. DIMENSIONS D AND E ARE DETERMINED AT THE OUTERMOST EXTREMES OF THE PLASTIC BODY.
6. DATUMS A AND B ARE DETERMINED AT DATUM PLANE H.

| DIM | INCHES | | MILLIMETERS | |
|-----|-----------|-------|-------------|-------|
| | MIN | MAX | MIN | MAX |
| A | 0.086 | 0.094 | 2.18 | 2.38 |
| A1 | 0.000 | 0.005 | 0.00 | 0.13 |
| b | 0.025 | 0.035 | 0.63 | 0.89 |
| b2 | 0.030 | 0.045 | 0.76 | 1.14 |
| b3 | 0.180 | 0.215 | 4.57 | 5.46 |
| c | 0.018 | 0.024 | 0.46 | 0.61 |
| c2 | 0.018 | 0.024 | 0.46 | 0.61 |
| D | 0.235 | 0.245 | 5.97 | 6.22 |
| E | 0.250 | 0.265 | 6.35 | 6.73 |
| e | 0.090 BSC | | 2.29 BSC | |
| H | 0.370 | 0.410 | 9.40 | 10.41 |
| L | 0.055 | 0.070 | 1.40 | 1.78 |
| L1 | 0.108 REF | | 2.74 REF | |
| L2 | 0.020 BSC | | 0.51 BSC | |
| L3 | 0.035 | 0.050 | 0.89 | 1.27 |
| L4 | --- | 0.040 | --- | 1.01 |
| Z | 0.155 | --- | 3.93 | --- |

SOLDERING FOOTPRINT*

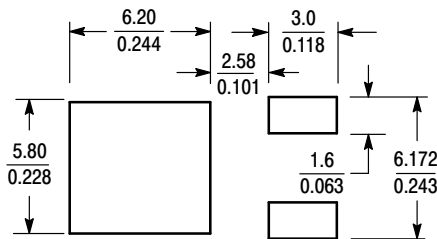

SCALE 3:1 (mm/inches)

STYLE 1:

1. BASE
2. COLLECTOR
3. EMITTER
4. COLLECTOR

*For additional information on our Pb-Free strategy and soldering details, please download the ON Semiconductor Soldering and Mounting Techniques Reference Manual, SOLDERRM/D.

MJD31 (NPN), MJD32 (PNP)

PACKAGE DIMENSIONS

IPAK CASE 369D ISSUE C

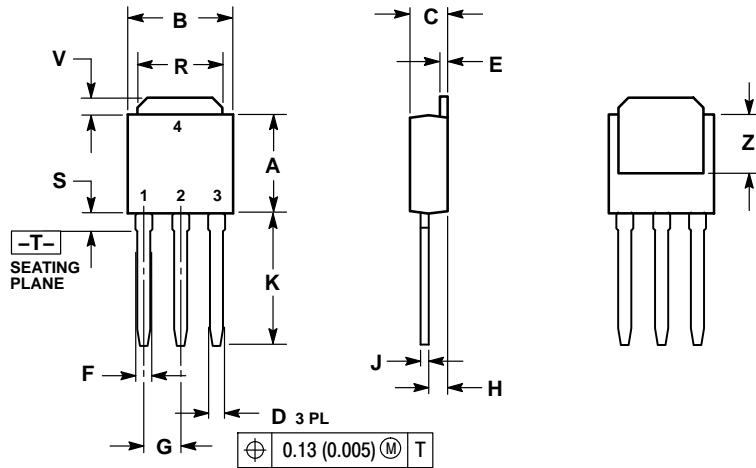

- NOTES:
1. DIMENSIONING AND TOLERANCING PER ANSI Y14.5M, 1982.
2. CONTROLLING DIMENSION: INCH.

| DIM | INCHES | | MILLIMETERS | |
|-----|--------|-------|-------------|------|
| | MIN | MAX | MIN | MAX |
| A | 0.235 | 0.245 | 5.97 | 6.35 |
| B | 0.250 | 0.265 | 6.35 | 6.73 |
| C | 0.086 | 0.094 | 2.19 | 2.38 |
| D | 0.027 | 0.035 | 0.69 | 0.88 |
| E | 0.018 | 0.023 | 0.46 | 0.58 |
| F | 0.037 | 0.045 | 0.94 | 1.14 |
| G | 0.090 | BSC | 2.29 | BSC |
| H | 0.034 | 0.040 | 0.87 | 1.01 |
| J | 0.018 | 0.023 | 0.46 | 0.58 |
| K | 0.350 | 0.380 | 8.89 | 9.65 |
| R | 0.180 | 0.215 | 4.45 | 5.45 |
| S | 0.025 | 0.040 | 0.63 | 1.01 |
| V | 0.035 | 0.050 | 0.89 | 1.27 |
| Z | 0.155 | --- | 3.93 | --- |

- STYLE 1:
PIN 1. BASE
2. COLLECTOR
3. EMITTER
4. COLLECTOR

ON Semiconductor and **ON** are registered trademarks of Semiconductor Components Industries, LLC (SCILLC). SCILLC owns the rights to a number of patents, trademarks, copyrights, trade secrets, and other intellectual property. A listing of SCILLC's product/patent coverage may be accessed at www.onsemi.com/site/pdf/Patent-Marking.pdf. SCILLC reserves the right to make changes without further notice to any products herein. SCILLC makes no warranty, representation or guarantee regarding the suitability of its products for any particular purpose, nor does SCILLC assume any liability arising out of the application or use of any product or circuit, and specifically disclaims any and all liability, including without limitation special, consequential or incidental damages. "Typical" parameters which may be provided in SCILLC data sheets and/or specifications can and do vary in different applications and actual performance may vary over time. All operating parameters, including "Typicals" must be validated for each customer application by customer's technical experts. SCILLC does not convey any license under its patent rights nor the rights of others. SCILLC products are not designed, intended, or authorized for use as components in systems intended for surgical implant into the body, or other applications intended to support or sustain life, or for any other application in which the failure of the SCILLC product could create a situation where personal injury or death may occur. Should Buyer purchase or use SCILLC products for any such unintended or unauthorized application, Buyer shall indemnify and hold SCILLC and its officers, employees, subsidiaries, affiliates, and distributors harmless against all claims, costs, damages, and expenses, and reasonable attorney fees arising out of, directly or indirectly, any claim of personal injury or death associated with such unintended or unauthorized use, even if such claim alleges that SCILLC was negligent regarding the design or manufacture of the part. SCILLC is an Equal Opportunity/Affirmative Action Employer. This literature is subject to all applicable copyright laws and is not for resale in any manner.

PUBLICATION ORDERING INFORMATION

LITERATURE FULFILLMENT:
Literature Distribution Center for ON Semiconductor
P.O. Box 5163, Denver, Colorado 80217 USA
Phone: 303-675-2175 or 800-344-3860 Toll Free USA/Canada
Fax: 303-675-2176 or 800-344-3867 Toll Free USA/Canada
Email: orderlit@onsemi.com

N. American Technical Support: 800-282-9855 Toll Free
USA/Canada
Europe, Middle East and Africa Technical Support:
Phone: 421 33 790 2910
Japan Customer Focus Center
Phone: 81-3-5817-1050

ON Semiconductor Website: www.onsemi.com
Order Literature: <http://www.onsemi.com/orderlit>
For additional information, please contact your local Sales Representative

Mouser Electronics

Authorized Distributor

Click to View Pricing, Inventory, Delivery & Lifecycle Information:

ON Semiconductor:

[MJD31C1G](#) [MJD31CG](#) [MJD31CRLG](#) [MJD31CT4G](#) [MJD31T4G](#) [MJD32CG](#) [MJD32CRLG](#) [MJD32CT4G](#)
[MJD32RLG](#) [MJD32T4G](#) [NJVMJD32CT4G](#) [NJVMJD32CG](#)