

NCP785A

Wide Input Voltage Range 10 mA Ultra-Low Iq, High PSRR Linear Regulator

The NCP785A is a high-performance linear regulator, offering a very wide operating input voltage range of up to 450 V DC, with an output current of up to 10 mA.

Ideal for high input voltage applications such as industrial and home metering, home appliances. The NCP785A family offers $\pm 5\%$ initial accuracy, extremely high-power supply rejection ratio and ultra-low quiescent current. The NCP785A is optimized for high-voltage line and load transients, making this part ideal for harsh environment applications.

The NCP785A is offered in fixed output voltage options 3.3 V, 5.0 V, 12 V and 15 V.

SOT-89 package offers good thermal performance and help to minimize the solution size.

Features

- Wide Input Voltage Range:
 - DC: Up to 450 V
 - AC: 85 V to 260 V (half-wave rectifier and 2.2 μF capacitor)
- 10 mA Guaranteed Output Current
- Ultra Low Quiescent Current: Typ. 10 μA ($V_{\text{OUT}} \leq 5 \text{ V}$)
- $\pm 5\%$ Accuracy Over Full Load, Line and Temperature Variations
- Ultra-high PSRR: 70 dB at 60 Hz, 90 dB at 100 kHz
- Stable with Ceramic Output Capacitor 22 μF MLCC
- Thermal Shutdown and Current Limit Protection
- Available in Thermally Enhanced SOT89-3 Package
- This is a Pb-Free Device

Typical Applications

- Industrial Applications, Home Appliances
- Home Metering / Network Application
- Off-line Power Supplies

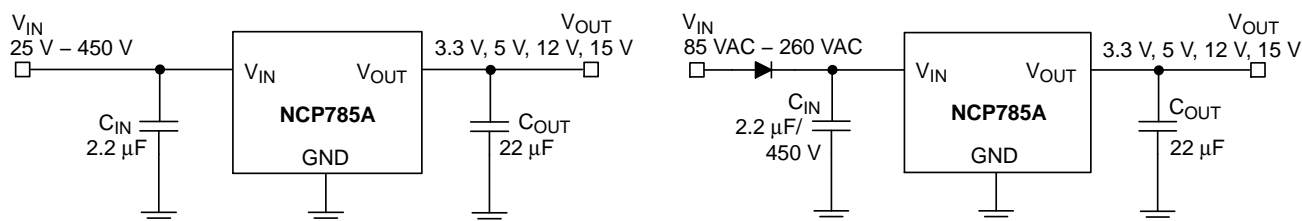

Figure 1. Typical Applications



ON Semiconductor®

www.onsemi.com

MARKING DIAGRAM



SOT-89
CASE 528AG

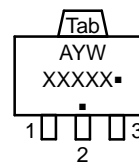

(Top Views)

(Tab is connected to Pin 2)

A = Assembly Location
Y = Year
W = Work Week
XXXXX = Specific Device Code
▪ = Pb-Free Package

(Note: Microdot may be in either location)

ORDERING INFORMATION

See detailed ordering and shipping information in the package dimensions section on page 9 of this data sheet.

NCP785A

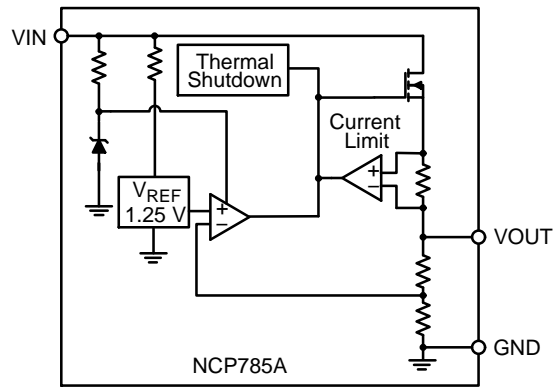

Figure 2. Simplified Internal Block Diagram

Table 1. PIN FUNCTION DESCRIPTION

Pin No. (SOT-89)	Pin Name	Description
1	VIN	Supply Voltage Input. Connect 2.2 μ F capacitor from VIN to GND.
2, Tab	GND	Ground connection.
3	VOUT	Regulator Output. Connect 22 μ F or larger MLCC capacitor from VOUT to GND.

Table 2. ABSOLUTE MAXIMUM RATINGS

Rating	Symbol	Value	Unit
Input Voltage (Note 1)	V_{IN}	-0.3 to 700	V
Output Voltage	V_{OUT}	-0.3 to 18	V
Maximum Junction Temperature	$T_{J(MAX)}$	150	$^{\circ}$ C
Storage Temperature	T_{STG}	-55 to 150	$^{\circ}$ C
ESD Capability, Human Body Model (All pins except HV pin no.1) (Note 2)	ESD_{HBM}	2000	V
ESD Capability, Machine Model (Note 2)	ESD_{MM}	200	V

Stresses exceeding those listed in the Maximum Ratings table may damage the device. If any of these limits are exceeded, device functionality should not be assumed, damage may occur and reliability may be affected.

1. Peak 650 V max 1 ms non repeated for 1 s
2. This device series incorporates ESD protection and is tested by the following methods:
 ESD Human Body Model tested per AEC-Q100-002 (EIA/JESD22-A114)
 ESD Machine Model tested per AEC-Q100-003 (EIA/JESD22-A115)
 Latch-up Current Maximum Rating tested per JEDEC standard: JESD78.

Table 3. THERMAL CHARACTERISTICS

Rating	Symbol	Value	Unit
Thermal Characteristics, SOT-89 Thermal Resistance, Junction-to-Air	$R_{\theta JA}$	79	$^{\circ}$ C/W

NCP785A

Table 4. ELECTRICAL CHARACTERISTICS, $V_{OUT} = 3.3\text{ V}$ ($-40^{\circ}\text{C} \leq T_J \leq 85^{\circ}\text{C}$; $V_{IN} = 340\text{ V}$; $I_{OUT} = 100\ \mu\text{A}$, $C_{IN} = 2.2\ \mu\text{F}$, $C_{OUT} = 22\ \mu\text{F}$, unless otherwise noted. Typical values are at $T_J = +25^{\circ}\text{C}$.) (Note 3)

Parameter	Test Conditions	Symbol	Min	Typ	Max	Unit
Operating Input Voltage DC		V_{IN}	25		450	V
Output Voltage Accuracy	$T_J = 25^{\circ}\text{C}$, $I_{OUT} = 100\ \mu\text{A}$, $25\text{ V} \leq V_{IN} \leq 450\text{ V}$	V_{OUT}	3.1515	3.3	3.4485	V
	$-40^{\circ}\text{C} \leq T_J \leq 85^{\circ}\text{C}$, $I_{OUT} = 100\ \mu\text{A}$, $25\text{ V} \leq V_{IN} \leq 450\text{ V}$	V_{OUT}	3.135	3.3	3.465	V
Line Regulation	$25\text{ V} \leq V_{IN} \leq 450\text{ V}$, $I_{OUT} = 100\ \mu\text{A}$	Reg_{LINE}	-0.5	0.2	+0.5	%
Load Regulation	$100\ \mu\text{A} \leq I_{OUT} \leq 10\text{ mA}$, $V_{IN} = 35\text{ V}$	Reg_{LOAD}	-1.0	0.6	+1.0	%
Maximum Output Current (Note 4)	$35\text{ V} \leq V_{IN} \leq 450\text{ V}$	I_{OUT}	10.5			mA
Quiescent Current	$I_{OUT} = 0$, $25\text{ V} \leq V_{IN} \leq 450\text{ V}$	I_Q		7.5	14	μA
Ground Current (Note 4)	$25\text{ V} \leq V_{IN} \leq 450\text{ V}$ $0 < I_{OUT} \leq 10\text{ mA}$	I_{GND}			15	μA
Power Supply Rejection Ratio	$V_{IN} = 340\text{ V}_{DC} + 1\text{ V}_{pp}$ modulation, $I_{OUT} = 100\ \mu\text{A}$	$f = 1\text{ kHz}$ PSRR		70		dB
Noise	$f = 100\text{ Hz to } 100\text{ kHz}$ $V_{IN} = 340\text{ V}_{DC}$, $I_{OUT} = 100\ \mu\text{A}$	V_{NOISE}		240		μV_{rms}
Thermal Shutdown Temperature (Note 5)	Temperature increasing from $T_J = +25^{\circ}\text{C}$	T_{SD}		145		$^{\circ}\text{C}$
Thermal Shutdown Hysteresis (Note 5)	Temperature falling from T_{SD}	T_{SDH}	-	10	-	$^{\circ}\text{C}$

Table 5. ELECTRICAL CHARACTERISTICS, $V_{OUT} = 5.0\text{ V}$ ($-40^{\circ}\text{C} \leq T_J \leq 85^{\circ}\text{C}$; $V_{IN} = 340\text{ V}$; $I_{OUT} = 100\ \mu\text{A}$, $C_{IN} = 2.2\ \mu\text{F}$, $C_{OUT} = 22\ \mu\text{F}$, unless otherwise noted. Typical values are at $T_J = +25^{\circ}\text{C}$.) (Note 3)

Parameter	Test Conditions	Symbol	Min	Typ	Max	Unit
Operating Input Voltage DC		V_{IN}	50		450	V
Output Voltage Accuracy	$T_J = 25^{\circ}\text{C}$, $I_{OUT} = 100\ \mu\text{A}$, $50\text{ V} \leq V_{IN} \leq 450\text{ V}$	V_{OUT}	4.775	5.0	5.225	V
	$-40^{\circ}\text{C} \leq T_J \leq 85^{\circ}\text{C}$, $I_{OUT} = 100\ \mu\text{A}$, $50\text{ V} \leq V_{IN} \leq 450\text{ V}$	V_{OUT}	4.75	5.0	5.25	V
Line Regulation	$50\text{ V} \leq V_{IN} \leq 450\text{ V}$, $I_{OUT} = 100\ \mu\text{A}$	Reg_{LINE}	-0.5	0.2	+0.5	%
Load Regulation	$100\ \mu\text{A} \leq I_{OUT} \leq 10\text{ mA}$, $V_{IN} = 55\text{ V}$	Reg_{LOAD}	-1.0	0.62	+1.0	%
Maximum Output Current (Note 4)	$55\text{ V} \leq V_{IN} \leq 450\text{ V}$	I_{OUT}	10.5			mA
Quiescent Current	$I_{OUT} = 0$, $50\text{ V} \leq V_{IN} \leq 450\text{ V}$	I_Q		16	21	μA
Ground Current (Note 4)	$50\text{ V} \leq V_{IN} \leq 450\text{ V}$ $0 < I_{OUT} \leq 10\text{ mA}$	I_{GND}			23	μA
Power Supply Rejection Ratio	$V_{IN} = 340\text{ V}_{DC} + 1\text{ V}_{pp}$ modulation, $I_{OUT} = 100\ \mu\text{A}$	$f = 1\text{ kHz}$ PSRR		70		dB
Noise	$f = 100\text{ Hz to } 100\text{ kHz}$ $V_{IN} = 340\text{ V}_{DC}$, $I_{OUT} = 100\ \mu\text{A}$	V_{NOISE}		300		μV_{rms}
Thermal Shutdown Temperature (Note 5)	Temperature increasing from $T_J = +25^{\circ}\text{C}$	T_{SD}		145		$^{\circ}\text{C}$
Thermal Shutdown Hysteresis (Note 5)	Temperature falling from T_{SD}	T_{SDH}	-	10	-	$^{\circ}\text{C}$

Product parametric performance is indicated in the Electrical Characteristics for the listed test conditions, unless otherwise noted. Product performance may not be indicated by the Electrical Characteristics if operated under different conditions.

3. Performance guaranteed over the indicated operating temperature range by design and/or characterization production tested at $T_J = T_A = 25^{\circ}\text{C}$. Low duty cycle pulse techniques are used during testing to maintain the junction temperature as close to ambient as possible.
4. A proper heatsinking and/or low duty cycle pulse techniques are used to operate the device within the Safe Operating Area.
5. Guaranteed by design

NCP785A

Table 6. ELECTRICAL CHARACTERISTICS, $V_{OUT} = 12\text{ V}$ ($-40^{\circ}\text{C} \leq T_J \leq 85^{\circ}\text{C}$; $V_{IN} = 340\text{ V}$; $I_{OUT} = 100\ \mu\text{A}$, $C_{IN} = 2.2\ \mu\text{F}$, $C_{OUT} = 22\ \mu\text{F}$, unless otherwise noted. Typical values are at $T_J = +25^{\circ}\text{C}$.) (Note 6)

Parameter	Test Conditions	Symbol	Min	Typ	Max	Unit
Operating Input Voltage DC		V_{IN}	55		450	V
Output Voltage Accuracy	$T_J = 25^{\circ}\text{C}$, $I_{OUT} = 100\ \mu\text{A}$, $55\text{ V} \leq V_{IN} \leq 450\text{ V}$	V_{OUT}	11.460	12	12.540	V
	$-40^{\circ}\text{C} \leq T_J \leq 85^{\circ}\text{C}$, $I_{OUT} = 100\ \mu\text{A}$, $55\text{ V} \leq V_{IN} \leq 450\text{ V}$	V_{OUT}	11.4	12	12.6	V
Line Regulation	$55\text{ V} \leq V_{IN} \leq 450\text{ V}$, $I_{OUT} = 100\ \mu\text{A}$	Reg_{LINE}	-0.5	0.1	+0.5	%/V
Load Regulation	$100\ \mu\text{A} \leq I_{OUT} \leq 10\text{ mA}$, $V_{IN} = 65\text{ V}$	Reg_{LOAD}	-1.0	0.66	+1.0	%
Maximum Output Current (Note 7)	$55\text{ V} \leq V_{IN} \leq 450\text{ V}$	I_{OUT}	10.5			mA
Quiescent Current	$I_{OUT} = 0$, $55\text{ V} \leq V_{IN} \leq 450\text{ V}$	I_Q		17	22	μA
Ground Current (Note 7)	$55\text{ V} \leq V_{IN} \leq 450\text{ V}$ $0 < I_{OUT} \leq 10\text{ mA}$	I_{GND}			25	μA
Power Supply Rejection Ratio	$V_{IN} = 340\text{ V}_{DC} + 1\text{ V}_{pp}$ modulation, $I_{OUT} = 100\ \mu\text{A}$	$f = 1\text{ kHz}$ $PSRR$		70		dB
Noise	$f = 100\text{ Hz to } 100\text{ kHz}$ $V_{IN} = 340\text{ V}_{DC}$, $I_{OUT} = 100\ \mu\text{A}$	V_{NOISE}		420		μV_{rms}
Thermal Shutdown Temperature (Note 8)	Temperature increasing from $T_J = +25^{\circ}\text{C}$	T_{SD}		145		$^{\circ}\text{C}$
Thermal Shutdown Hysteresis (Note 8)	Temperature falling from T_{SD}	T_{SDH}	-	10	-	$^{\circ}\text{C}$

Table 7. ELECTRICAL CHARACTERISTICS, $V_{OUT} = 15\text{ V}$ ($-40^{\circ}\text{C} \leq T_J \leq 85^{\circ}\text{C}$; $V_{IN} = 340\text{ V}$; $I_{OUT} = 100\ \mu\text{A}$, $C_{IN} = 2.2\ \mu\text{F}$, $C_{OUT} = 22\ \mu\text{F}$, unless otherwise noted. Typical values are at $T_J = +25^{\circ}\text{C}$.) (Note 6)

Parameter	Test Conditions	Symbol	Min	Typ	Max	Unit
Operating Input Voltage DC		V_{IN}	60		450	V
Output Voltage Accuracy	$T_J = 25^{\circ}\text{C}$, $I_{OUT} = 100\ \mu\text{A}$, $60\text{ V} \leq V_{IN} \leq 450\text{ V}$	V_{OUT}	14.325	15	15.675	V
	$-40^{\circ}\text{C} \leq T_J \leq 85^{\circ}\text{C}$, $I_{OUT} = 100\ \mu\text{A}$, $60\text{ V} \leq V_{IN} \leq 450\text{ V}$	V_{OUT}	14.25	15	15.75	V
Line Regulation	$60\text{ V} \leq V_{IN} \leq 450\text{ V}$, $I_{OUT} = 100\ \mu\text{A}$	Reg_{LINE}	-0.5	0.1	+0.5	%/V
Load Regulation	$100\ \mu\text{A} \leq I_{OUT} \leq 10\text{ mA}$, $V_{IN} = 65\text{ V}$	Reg_{LOAD}	-1.0	0.66	+1.0	%
Maximum Output Current (Note 7)	$65\text{ V} \leq V_{IN} \leq 450\text{ V}$	I_{OUT}	10.5			mA
Quiescent Current	$I_{OUT} = 0$, $60\text{ V} \leq V_{IN} \leq 450\text{ V}$	I_Q		18	22	μA
Ground Current (Note 7)	$60\text{ V} \leq V_{IN} \leq 450\text{ V}$ $0 < I_{OUT} \leq 10\text{ mA}$	I_{GND}			25	μA
Power Supply Rejection Ratio	$V_{IN} = 340\text{ V}_{DC} + 1\text{ V}_{pp}$ modulation, $I_{OUT} = 100\ \mu\text{A}$	$f = 1\text{ kHz}$ $PSRR$		70		dB
Noise	$f = 100\text{ Hz to } 100\text{ kHz}$ $V_{IN} = 340\text{ V}_{DC}$, $I_{OUT} = 100\ \mu\text{A}$	V_{NOISE}		500		μV_{rms}
Thermal Shutdown Temperature (Note 8)	Temperature increasing from $T_J = +25^{\circ}\text{C}$	T_{SD}		145		$^{\circ}\text{C}$
Thermal Shutdown Hysteresis (Note 8)	Temperature falling from T_{SD}	T_{SDH}	-	10	-	$^{\circ}\text{C}$

Product parametric performance is indicated in the Electrical Characteristics for the listed test conditions, unless otherwise noted. Product performance may not be indicated by the Electrical Characteristics if operated under different conditions.

6. Performance guaranteed over the indicated operating temperature range by design and/or characterization production tested at $T_J = T_A = 25^{\circ}\text{C}$. Low duty cycle pulse techniques are used during testing to maintain the junction temperature as close to ambient as possible.
7. A proper heatsinking and/or low duty cycle pulse techniques are used to operate the device within the Safe Operating Area.
8. Guaranteed by design

NCP785A

TYPICAL CHARACTERISTICS

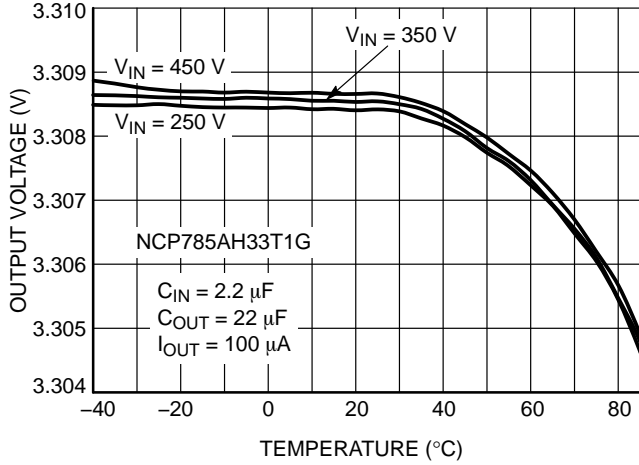

Figure 3. Output Voltage vs. Temperature

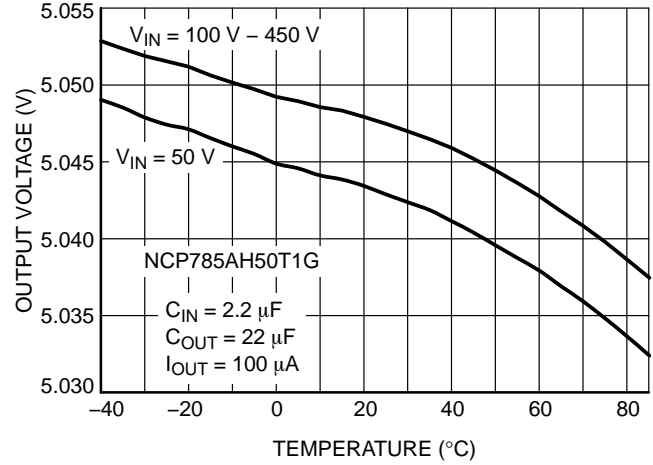

Figure 4. Output Voltage vs. Temperature

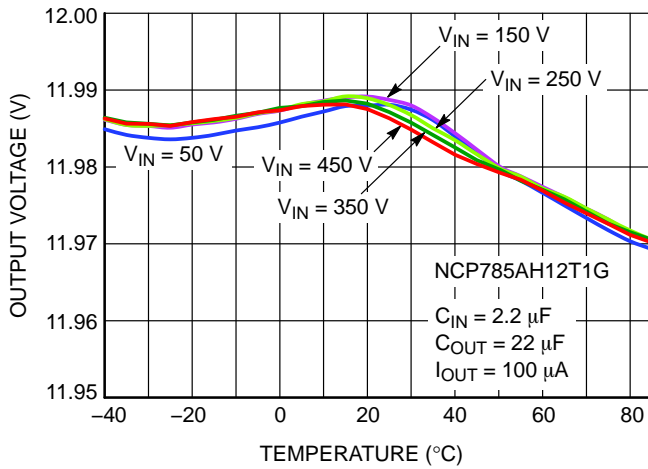

Figure 5. Output Voltage vs. Temperature

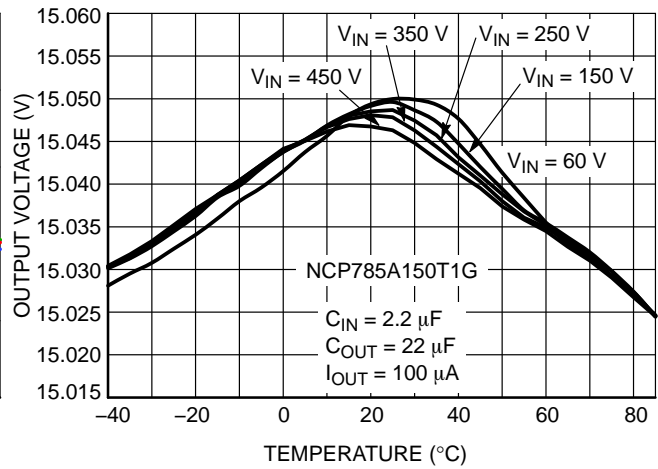

Figure 6. Output Voltage vs. Temperature

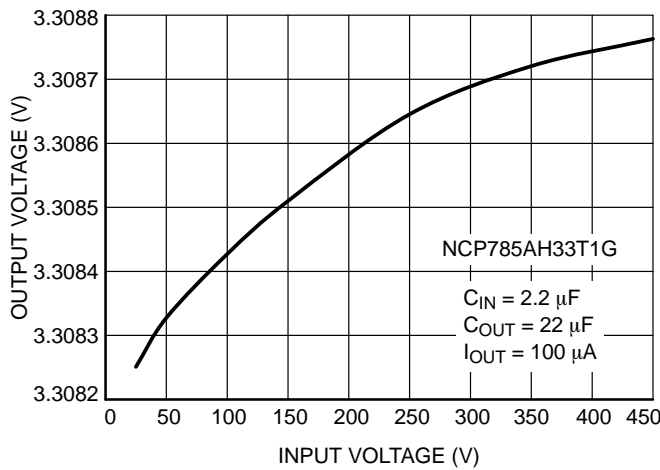

Figure 7. Output Voltage vs. Input Voltage

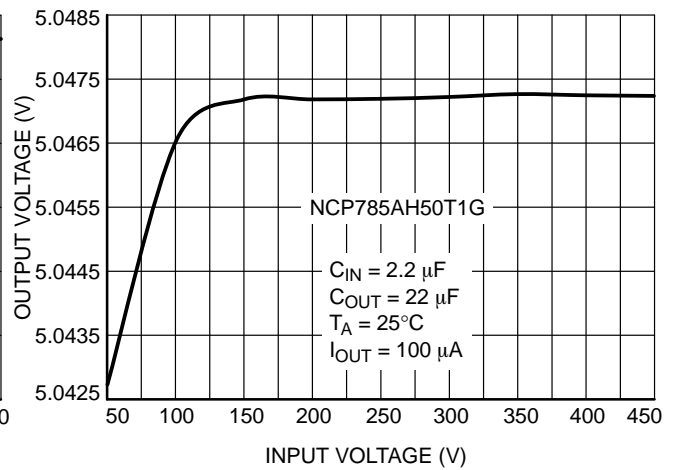

Figure 8. Output Voltage vs. Input Voltage

NCP785A

TYPICAL CHARACTERISTICS

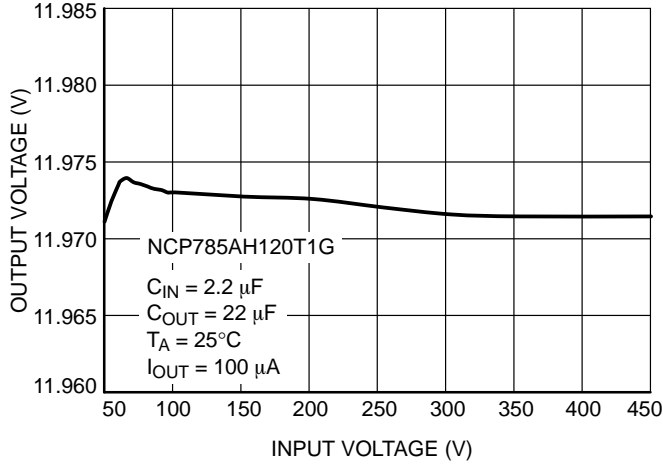

Figure 9. Output Voltage vs. Input Voltage

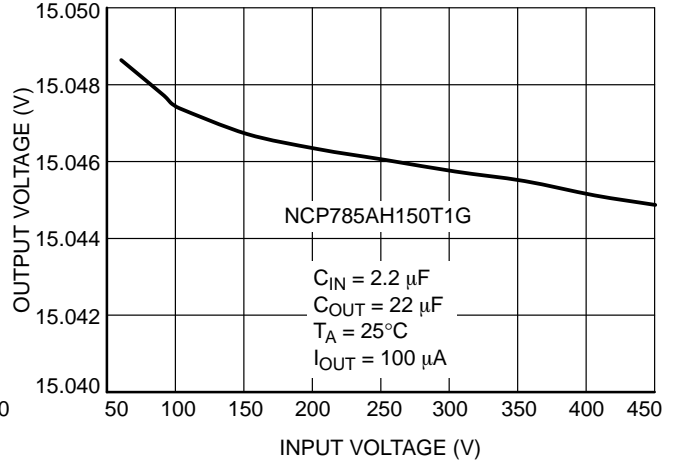

Figure 10. Output Voltage vs. Input Voltage

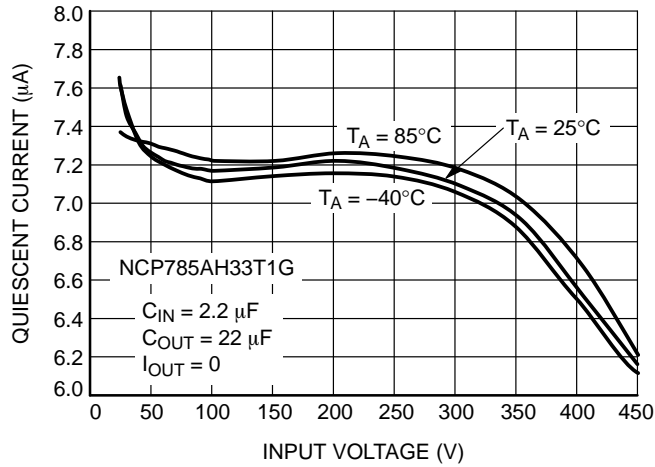

Figure 11. Quiescent Current vs. Input Voltage

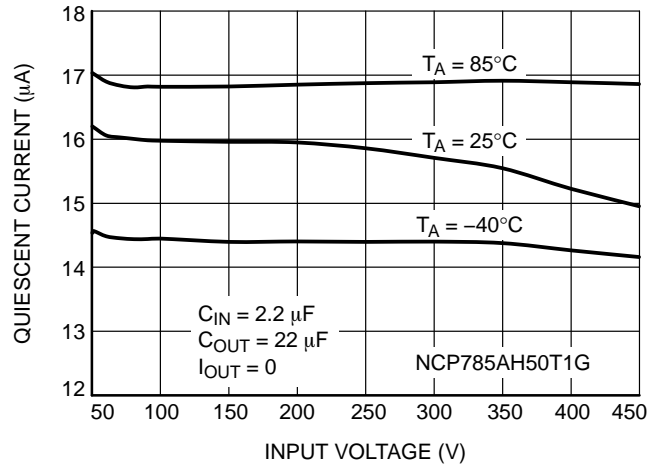

Figure 12. Quiescent Current vs. Input Voltage

NCP785A

TYPICAL CHARACTERISTICS

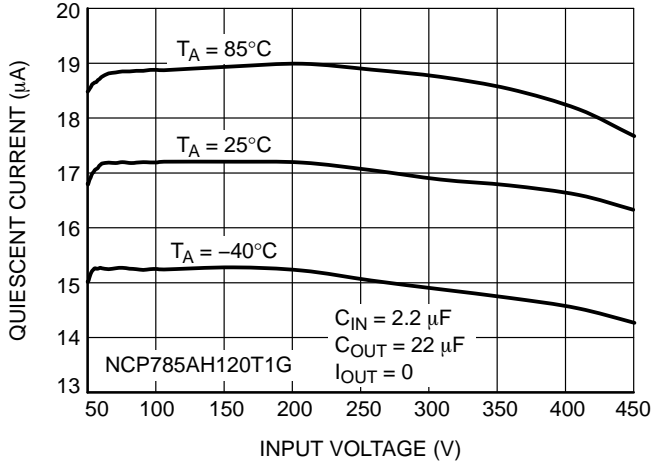

Figure 13. Quiescent Current vs. Input Voltage

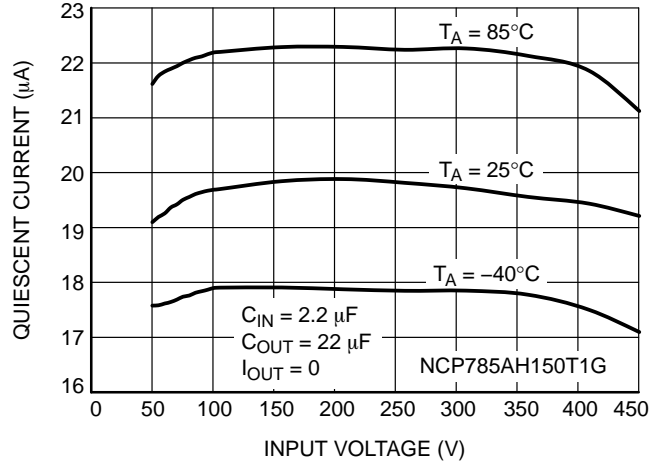

Figure 14. Quiescent Current vs. Input Voltage

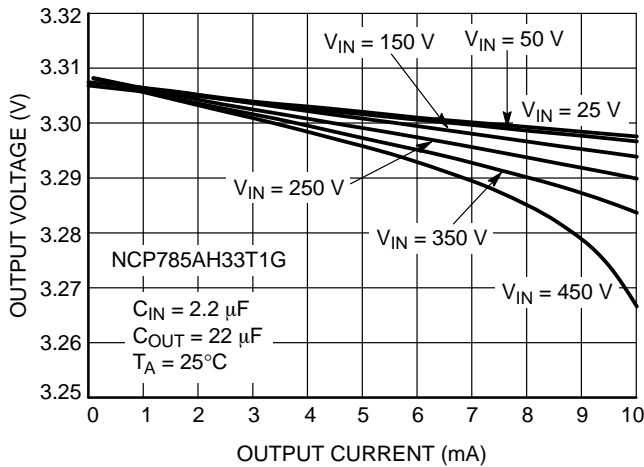

Figure 15. Output Voltage vs. Output Current

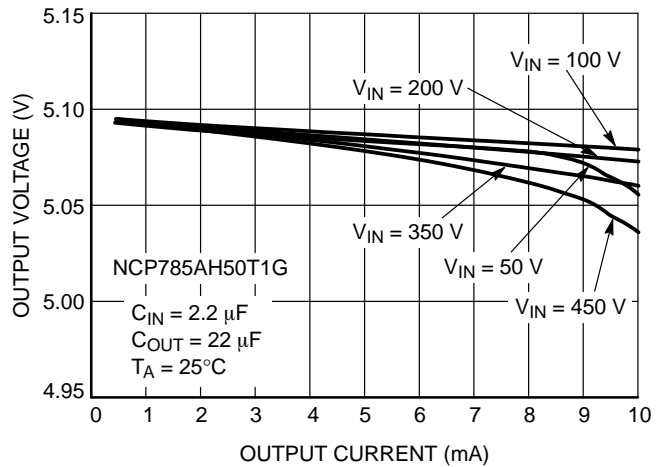

Figure 16. Output Voltage vs. Output Current

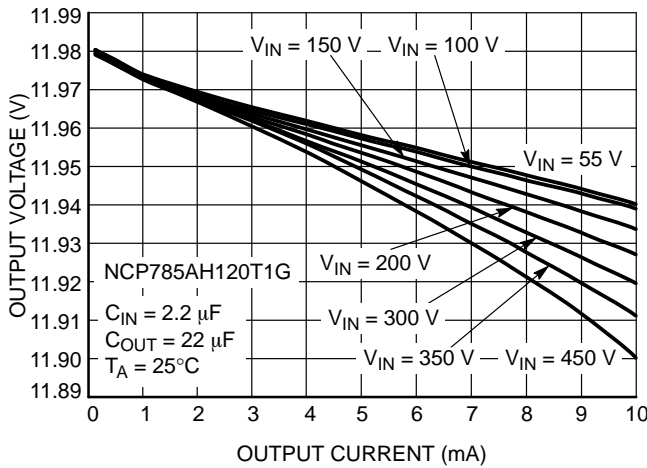

Figure 17. Output Voltage vs. Output Current

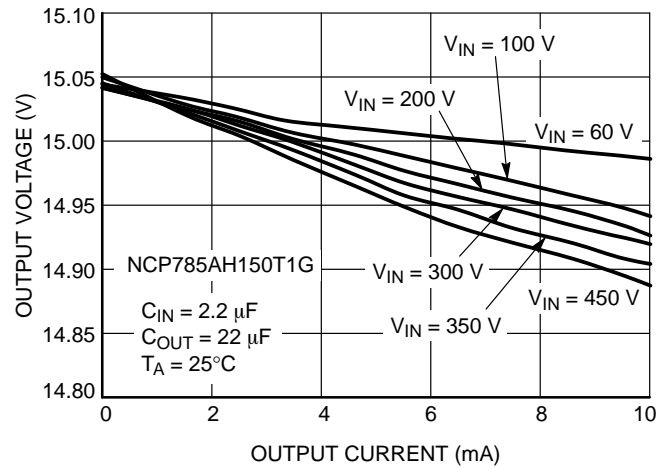

Figure 18. Output Voltage vs. Output Current

NCP785A

TYPICAL CHARACTERISTICS

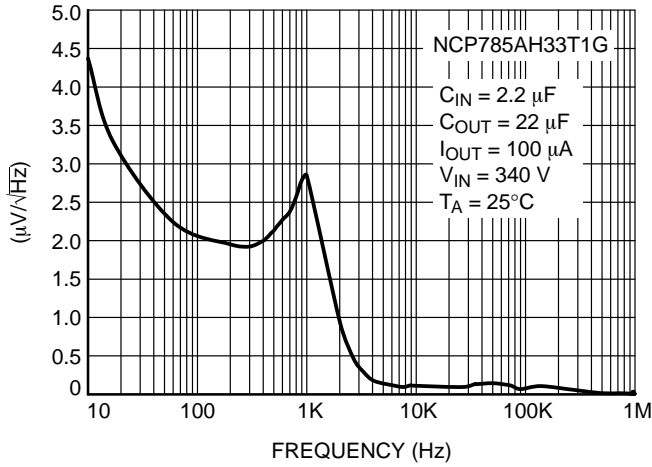

Figure 19. Output Noise Density vs. Frequency

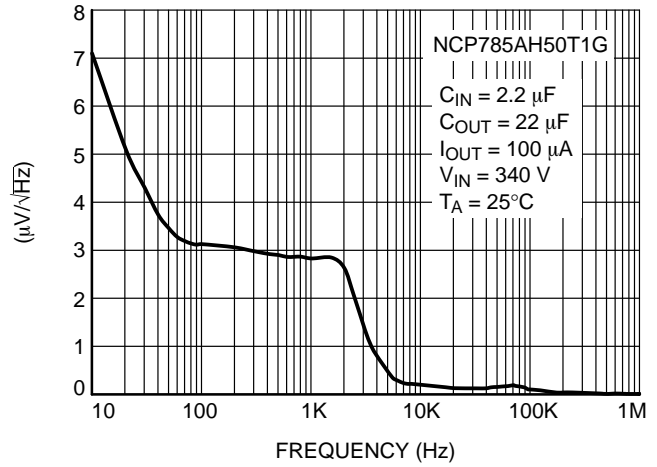

Figure 20. Output Noise Density vs. Frequency

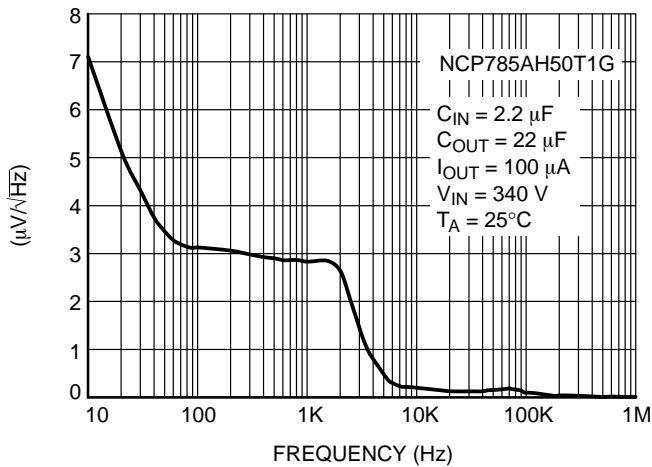

Figure 21. Output Noise Density vs. Frequency

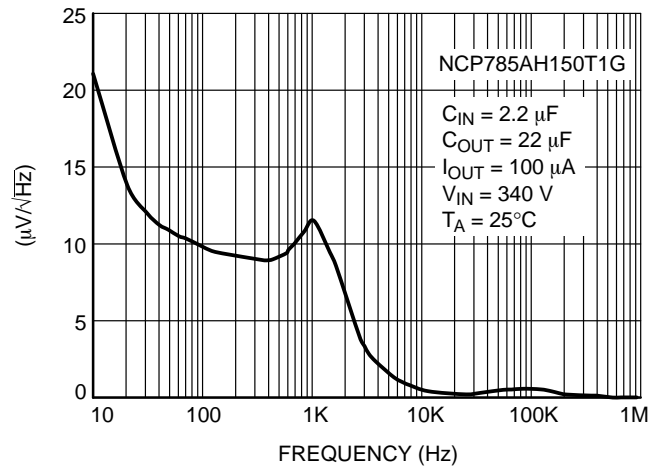

Figure 22. Output Noise Density vs. Frequency

NCP785A

APPLICATION INFORMATION

The typical application circuit for the NCP785A device is shown below.

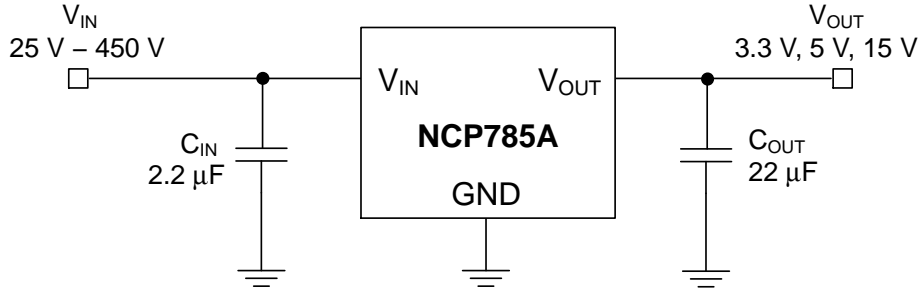

Figure 23. Typical Application Schematic

Input Decoupling (C1)

A 1 μF capacitor either ceramic or electrolytic is recommended and should be connected close to the input pin of NCP785A. Higher value 2.2 μF is necessary to sustain the required minimum input voltage at full load for AC voltage as low as 85 V with half wave rectifier.

Output Decoupling (C2)

The NCP785A Regulator does not require any specific Equivalent Series Resistance (ESR). Thus capacitors exhibiting ESRs ranging from a few $\text{m}\Omega$ up to 0.5 Ω can be used safely. The minimum decoupling value is 22 μF . The regulator accepts ceramic chip capacitors as well as tantalum devices or low ESR electrolytic capacitors. Larger values improve noise rejection and load transient response.

Layout Recommendations

Please be sure the V_{IN} and GND lines are sufficiently wide. When the impedance of these lines is high, there is a chance to pick up noise or to cause the malfunction of regulator.

Set external components, especially the output capacitor, as close as possible to the circuit, and make leads as short as possible.

Thermal

As power across the NCP785A increases, it might become necessary to provide some thermal relief. The maximum power dissipation supported by the device is dependent upon board design layout and used package. Mounting pad configuration on the PCB, the board material, and also the ambient temperature affect the rate of temperature rise for the part. This is stating that when the NCP785A has good thermal conductivity through the PCB, the junction temperature will be relatively low with high power dissipation applications.

ORDERING INFORMATION

Part Number	Output Voltage	Marking	Package	Shipping [†]
NCP785AH33T1G	3.3 V	AA	SOT-89 (Pb-Free)	1000 / Tape & Reel
NCP785AH50T1G	5 V	AC		
NCP785AH120T1G	12 V	AJ		
NCP785AH150T1G	15 V	AD		

[†]For information on tape and reel specifications, including part orientation and tape sizes, please refer to our Tape and Reel Packaging Specifications Brochure, BRD8011/D.

NCP785A

PACKAGE DIMENSIONS

SOT-89, 3 LEAD CASE 528AG ISSUE O

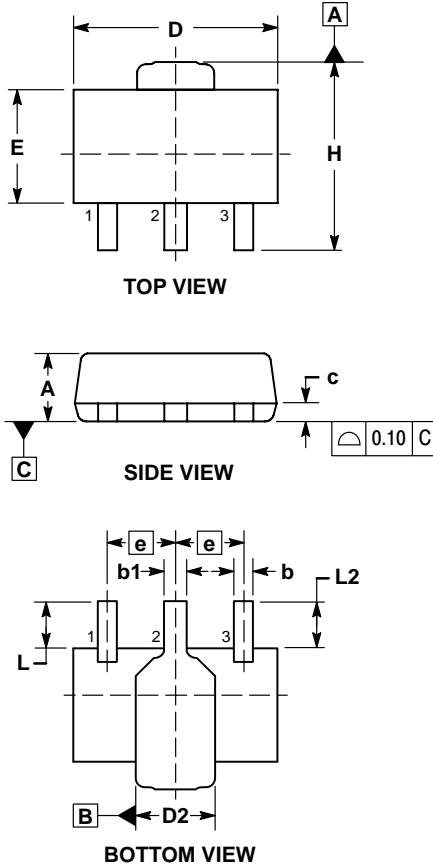

NOTES:

1. DIMENSIONING AND TOLERANCING PER ASME Y14.5M, 1994.
2. CONTROLLING DIMENSION: MILLIMETERS.
3. LEAD THICKNESS INCLUDES LEAD FINISH.
4. DIMENSIONS D AND E DO NOT INCLUDE MOLD FLASH, PROTRUSIONS, OR GATE BURRS.
5. DIMENSIONS L, L2, D2, AND H ARE MEASURED AT DATUM PLANE C.
6. CENTER LEAD CONTOUR MAY VARY WITHIN THE REGION DEFINED BY DIMENSION E.
7. DIMENSION D2 IS DEFINED AT ITS WIDEST POINT.

MILLIMETERS		
DIM	MIN	MAX
A	1.40	1.60
b	0.38	0.47
b1	0.46	0.55
c	0.40	0.44
D	4.40	4.60
D2	1.60	1.90
E	2.40	2.60
e	1.50 BSC	
H	4.05	4.25
L	0.89	1.20

RECOMMENDED MOUNTING FOOTPRINT*

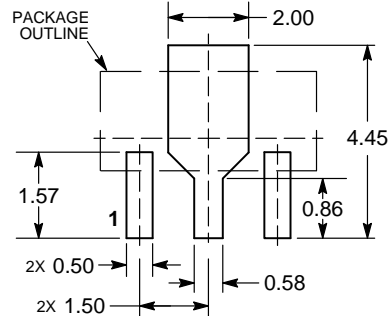

DIMENSIONS: MILLIMETERS

*For additional information on our Pb-Free strategy and soldering details, please download the ON Semiconductor Soldering and Mounting Techniques Reference Manual, SOLDERRM/D.

ON Semiconductor and the  are registered trademarks of Semiconductor Components Industries, LLC (SCILLC) or its subsidiaries in the United States and/or other countries. SCILLC owns the rights to a number of patents, trademarks, copyrights, trade secrets, and other intellectual property. A listing of SCILLC's product/patent coverage may be accessed at www.onsemi.com/site/pdf/Patent-Marking.pdf. SCILLC reserves the right to make changes without further notice to any products herein. SCILLC makes no warranty, representation or guarantee regarding the suitability of its products for any particular purpose, nor does SCILLC assume any liability arising out of the application or use of any product or circuit, and specifically disclaims any and all liability, including without limitation special, consequential or incidental damages. "Typical" parameters which may be provided in SCILLC data sheets and/or specifications can and do vary in different applications and actual performance may vary over time. All operating parameters, including "Typicals" must be validated for each customer application by customer's technical experts. SCILLC does not convey any license under its patent rights nor the rights of others. SCILLC products are not designed, intended, or authorized for use as components in systems intended for surgical implant into the body, or other applications intended to support or sustain life, or for any other application in which the failure of the SCILLC product could create a situation where personal injury or death may occur. Should Buyer purchase or use SCILLC products for any such unintended or unauthorized application, Buyer shall indemnify and hold SCILLC and its officers, employees, subsidiaries, affiliates, and distributors harmless against all claims, costs, damages, and expenses, and reasonable attorney fees arising out of, directly or indirectly, any claim of personal injury or death associated with such unintended or unauthorized use, even if such claim alleges that SCILLC was negligent regarding the design or manufacture of the part. SCILLC is an Equal Opportunity/Affirmative Action Employer. This literature is subject to all applicable copyright laws and is not for resale in any manner.

PUBLICATION ORDERING INFORMATION

LITERATURE FULFILLMENT:

Literature Distribution Center for ON Semiconductor
P.O. Box 5163, Denver, Colorado 80217 USA
Phone: 303-675-2175 or 800-344-3860 Toll Free USA/Canada
Fax: 303-675-2176 or 800-344-3867 Toll Free USA/Canada
Email: orderlit@onsemi.com

N. American Technical Support: 800-282-9855 Toll Free
USA/Canada
Europe, Middle East and Africa Technical Support:
Phone: 421 33 790 2910
Japan Customer Focus Center
Phone: 81-3-5817-1050

ON Semiconductor Website: www.onsemi.com

Order Literature: <http://www.onsemi.com/orderlit>

For additional information, please contact your local Sales Representative

Mouser Electronics

Authorized Distributor

Click to View Pricing, Inventory, Delivery & Lifecycle Information:

[ON Semiconductor:](#)

[NCP785AH33T1G](#) [NCP785AH50T1G](#) [NCP785AH150T1G](#) [NCP785AH120T1G](#)