

# NTST20120CTG, NTSJ20120CTG, NTSB20120CT-1G, NTSB20120CTG, NTSB20120CTT4G



ON Semiconductor®

[www.onsemi.com](http://www.onsemi.com)

## Very Low Forward Voltage Trench-based Schottky Rectifier

Exceptionally Low  $V_F = 0.54\text{ V}$  at  $I_F = 5\text{ A}$

### Features

- Fine Lithography Trench-based Schottky Technology for Very Low Forward Voltage and Low Leakage
- Fast Switching with Exceptional Temperature Stability
- Low Power Loss and Lower Operating Temperature
- Higher Efficiency for Achieving Regulatory Compliance
- Low Thermal Resistance
- High Surge Capability
- These are Pb-Free Devices

### Typical Applications

- Switching Power Supplies including Notebook / Netbook Adapters, ATX and Flat Panel Display
- High Frequency and DC-DC Converters
- Freewheeling and OR-ing diodes
- Reverse Battery Protection
- Instrumentation

### Mechanical Characteristics

- Case: Epoxy, Molded
- Epoxy Meets Flammability Rating UL 94-0 @ 0.125 in
- Finish: All External Surfaces Corrosion Resistant and Terminal Leads are Readily Solderable
- Lead Temperature for Soldering Purposes: 260°C Maximum for 10 sec

VERY LOW FORWARD  
VOLTAGE, LOW LEAKAGE  
SCHOTTKY BARRIER  
RECTIFIERS 20 AMPERES,  
120 VOLTS

### PIN CONNECTIONS

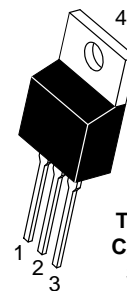
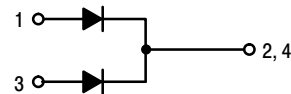

TO-220AB  
CASE 221A  
STYLE 6

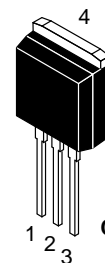

I2PAK  
CASE 418D  
STYLE 3

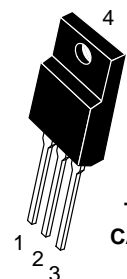

TO-220FP  
CASE 221AH

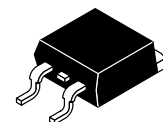

D2PAK  
CASE 418B

### ORDERING INFORMATION

See detailed ordering and shipping information in the package dimensions section on page 5 of this data sheet.

**NTST20120CTG, NTSJ20120CTG, NTSB20120CT-1G, NTSB20120CTG,  
NTSB20120CTT4G**

**MAXIMUM RATINGS**

Rating	Symbol	Value	Unit
Peak Repetitive Reverse Voltage Working Peak Reverse Voltage DC Blocking Voltage	$V_{RRM}$ $V_{RWM}$ $V_R$	120	V
Average Rectified Forward Current (Rated $V_R$ , $T_C = 130^\circ\text{C}$ )	$I_{F(AV)}$	20 10	A
Peak Repetitive Forward Current (Rated $V_R$ , Square Wave, 20 kHz, $T_C = 135^\circ\text{C}$ )	$I_{FRM}$	40 20	A
Nonrepetitive Peak Surge Current (Surge applied at rated load conditions halfwave, single phase, 60 Hz)	$I_{FSM}$	120	A
Operating Junction Temperature	$T_J$	-40 to +150	$^\circ\text{C}$
Storage Temperature	$T_{stg}$	-40 to +150	$^\circ\text{C}$
Voltage Rate of Change (Rated $V_R$ )	dv/dt	10,000	V/ $\mu\text{s}$

Stresses exceeding those listed in the Maximum Ratings table may damage the device. If any of these limits are exceeded, device functionality should not be assumed, damage may occur and reliability may be affected.

**THERMAL CHARACTERISTICS**

Rating	Symbol	NTST20120CTG NTSB20120CT-1G	NTSB20120CTG	NTSJ20120CTG	Unit
Maximum Thermal Resistance per Diode Junction-to-Case Junction-to-Ambient	$R_{\theta JC}$ $R_{\theta JA}$	2.5 70	1.43 46.8	4.42 105	$^\circ\text{C/W}$ $^\circ\text{C/W}$

**ELECTRICAL CHARACTERISTICS** (Per Leg unless otherwise noted)

Rating	Symbol	Typ	Max	Unit
Maximum Instantaneous Forward Voltage (Note 1) ( $I_F = 5\text{ A}$ , $T_J = 25^\circ\text{C}$ ) ( $I_F = 10\text{ A}$ , $T_J = 25^\circ\text{C}$ )  ( $I_F = 5\text{ A}$ , $T_J = 125^\circ\text{C}$ ) ( $I_F = 10\text{ A}$ , $T_J = 125^\circ\text{C}$ )	$V_F$	0.62 0.90  0.54 0.64	- 1.10  - 0.72	V
Maximum Instantaneous Reverse Current (Note 1) ( $V_R = 90\text{ V}$ , $T_J = 25^\circ\text{C}$ ) ( $V_R = 90\text{ V}$ , $T_J = 125^\circ\text{C}$ )  (Rated dc Voltage, $T_J = 25^\circ\text{C}$ ) (Rated dc Voltage, $T_J = 125^\circ\text{C}$ )	$I_R$	12 6  - 17	- -  700 100	$\mu\text{A}$ mA  $\mu\text{A}$ mA

Product parametric performance is indicated in the Electrical Characteristics for the listed test conditions, unless otherwise noted. Product performance may not be indicated by the Electrical Characteristics if operated under different conditions.

1. Pulse Test: Pulse Width = 300  $\mu\text{s}$ , Duty Cycle  $\leq 2.0\%$

**NTST20120CTG, NTSJ20120CTG, NTSB20120CT-1G, NTSB20120CTG,  
NTSB20120CTT4G**

**TYPICAL CHARACTERISTICS**

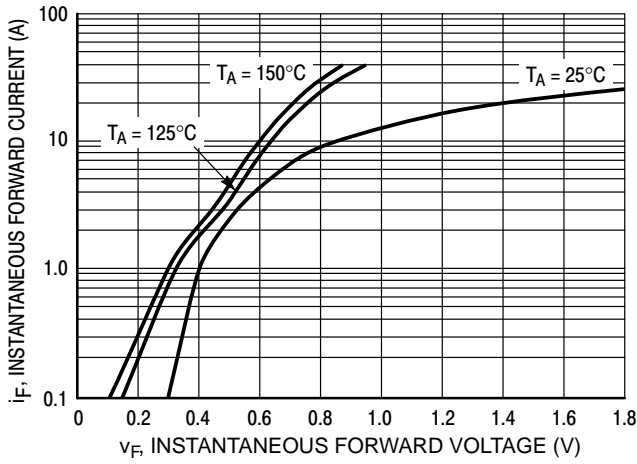

**Figure 1. Typical Instantaneous Forward Characteristics**

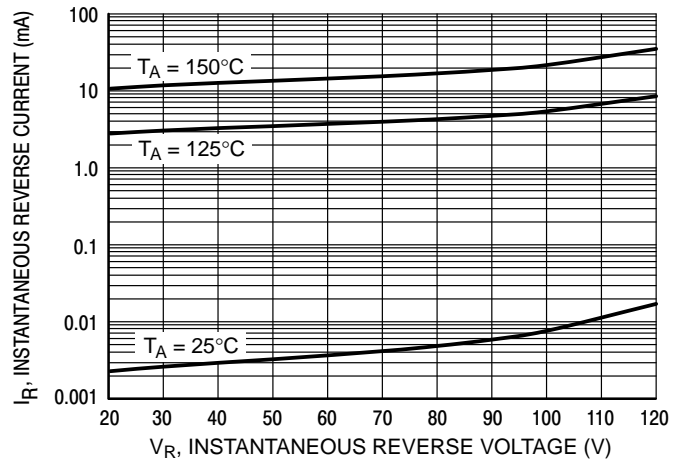

**Figure 2. Typical Reverse Current Characteristics**

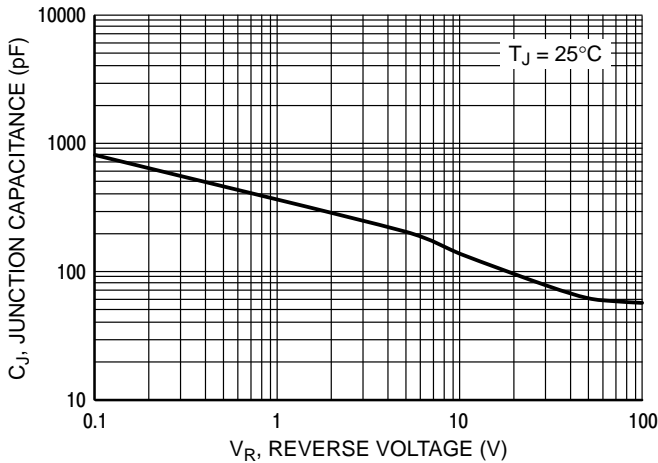

**Figure 3. Typical Junction Capacitance**

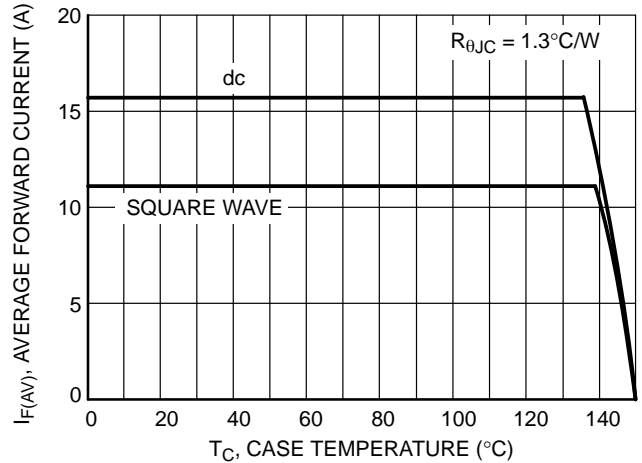

**Figure 4. Current Derating per Leg**

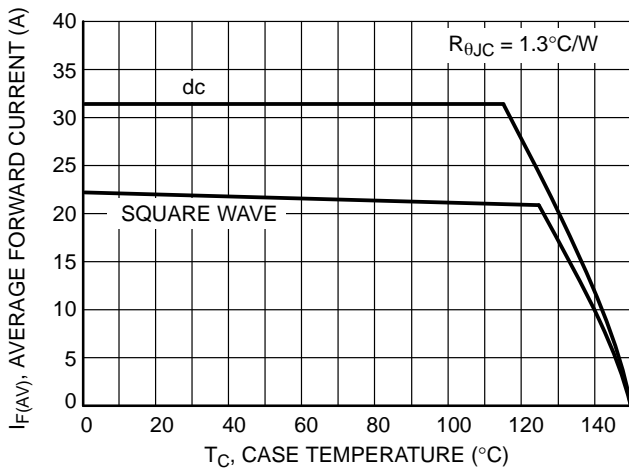

**Figure 5. Current Derating**

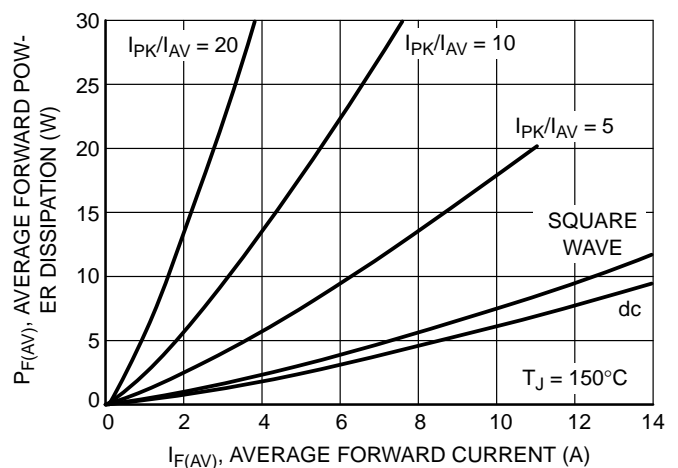

**Figure 6. Forward Power Dissipation**

**NTST20120CTG, NTSJ20120CTG, NTSB20120CT-1G, NTSB20120CTG,  
NTSB20120CTT4G**

**TYPICAL CHARACTERISTICS**

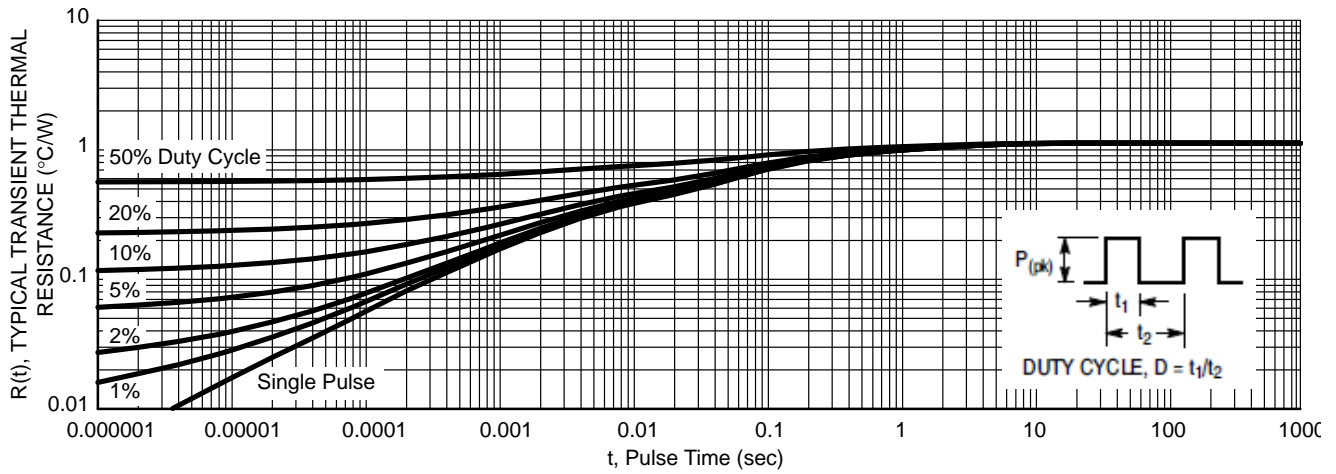

**Figure 7. Typical Transient Thermal Response for NTST20120CT and NTSB20120CT-1G**

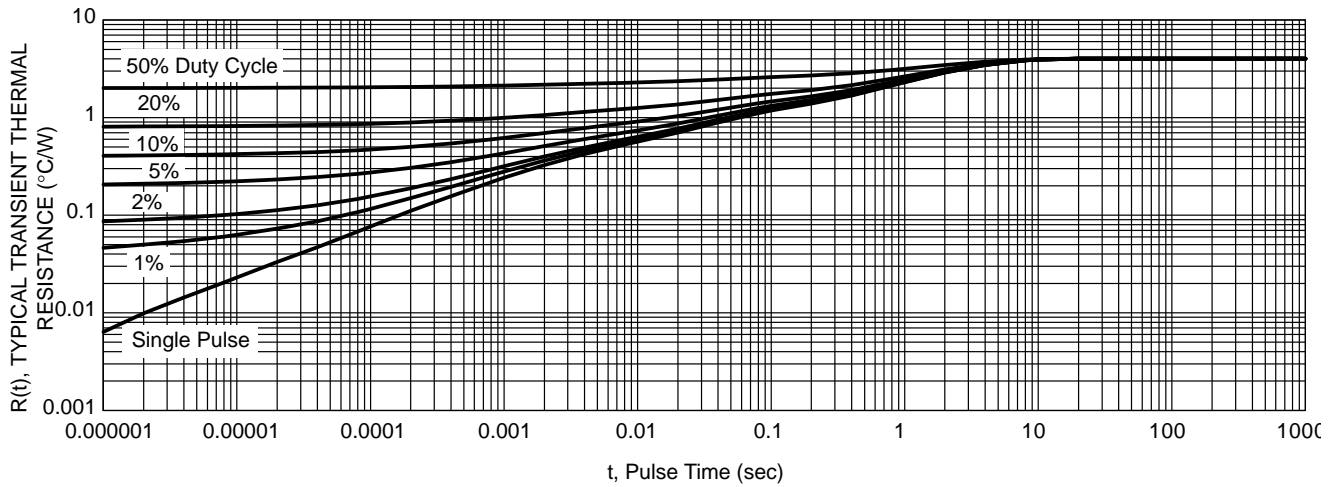

**Figure 8. Typical Transient Thermal Response for NTSJ20120CTG**

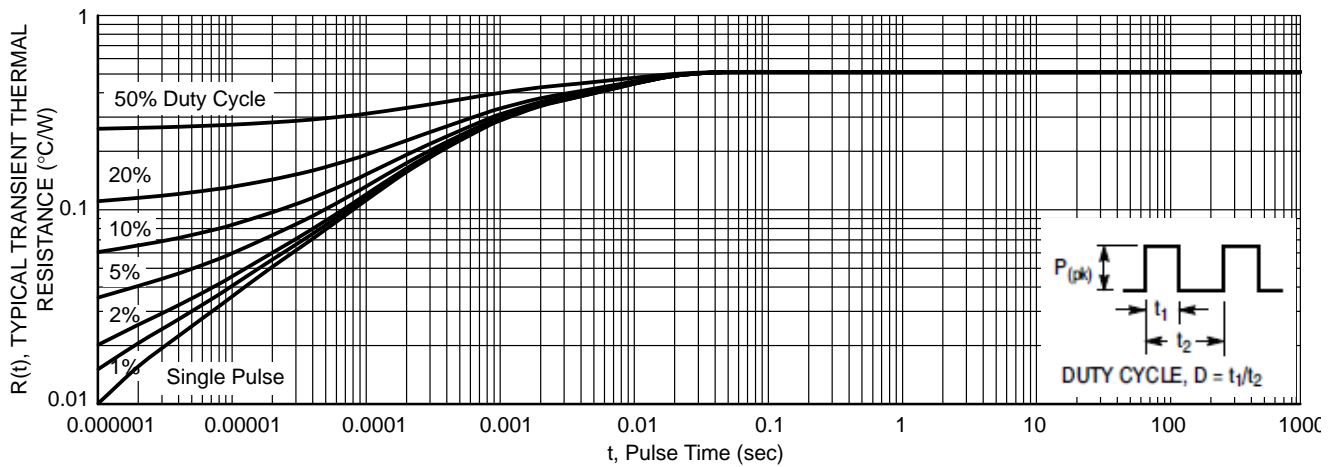

**Figure 9. Typical Transient Thermal Response for NTSB20120CTG**

# NTST20120CTG, NTSJ20120CTG, NTSB20120CT-1G, NTSB20120CTG, NTSB20120CTT4G

## ORDERING INFORMATION

Device	Package	Shipping
NTST20120CTG	TO-220AB (Pb-Free)	50 Units / Rail
NTSJ20120CTG	TO-220FP (Halide-Free)	50 Units / Rail
NTSB20120CT-1G	I <sup>2</sup> PAK (Pb-Free)	50 Units / Rail
NTSB20120CTG	D <sup>2</sup> PAK (Pb-Free)	50 Units / Rail
NTSB20120CTT4G	D <sup>2</sup> PAK (Pb-Free)	800 / Tape & Reel

## MARKING DIAGRAMS

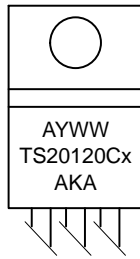

TO-220AB

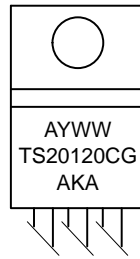

TO-220FP

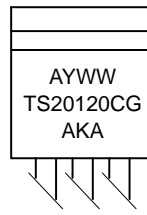

I<sup>2</sup>PAK

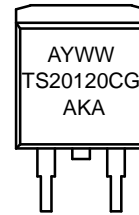

D<sup>2</sup>PAK

- A = Assembly Location
- Y = Year
- WW = Work Week
- AKA = Polarity Designator
- x = G or H
- G = Pb-Free Package
- H = Halide-Free Package

**NTST20120CTG, NTSJ20120CTG, NTSB20120CT-1G, NTSB20120CTG,  
NTSB20120CTT4G**

**PACKAGE DIMENSIONS**

**TO-220**  
CASE 221A-09  
ISSUE AH

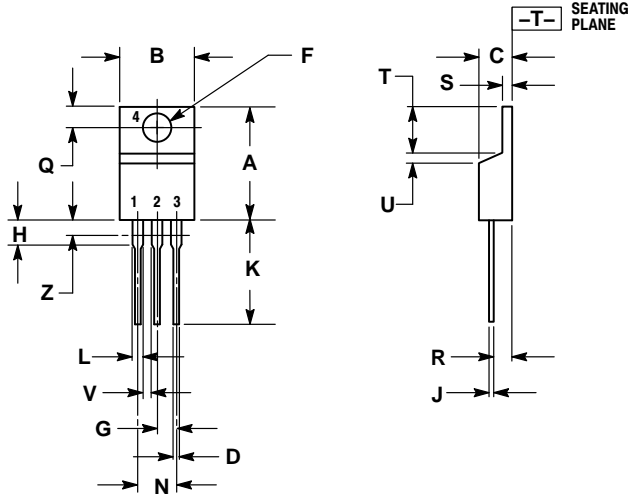

- NOTES:
1. DIMENSIONING AND TOLERANCING PER ANSI Y14.5M, 1982.
  2. CONTROLLING DIMENSION: INCH.
  3. DIMENSION Z DEFINES A ZONE WHERE ALL BODY AND LEAD IRREGULARITIES ARE ALLOWED.

DIM	INCHES		MILLIMETERS	
	MIN	MAX	MIN	MAX
A	0.570	0.620	14.48	15.75
B	0.380	0.415	9.66	10.53
C	0.160	0.190	4.07	4.83
D	0.025	0.038	0.64	0.96
F	0.142	0.161	3.61	4.09
G	0.095	0.105	2.42	2.66
H	0.110	0.161	2.80	4.10
J	0.014	0.024	0.36	0.61
K	0.500	0.562	12.70	14.27
L	0.045	0.060	1.15	1.52
N	0.190	0.210	4.83	5.33
Q	0.100	0.120	2.54	3.04
R	0.080	0.110	2.04	2.79
S	0.045	0.055	1.15	1.39
T	0.235	0.255	5.97	6.47
U	0.000	0.050	0.00	1.27
V	0.045	---	1.15	---
Z	---	0.080	---	2.04

- STYLE 6:  
PIN 1. ANODE  
2. CATHODE  
3. ANODE  
4. CATHODE

# NTST20120CTG, NTSJ20120CTG, NTSB20120CT-1G, NTSB20120CTG, NTSB20120CTT4G

## PACKAGE DIMENSIONS

**TO-220 FULLPACK, 3-LEAD**  
CASE 221AH  
ISSUE F

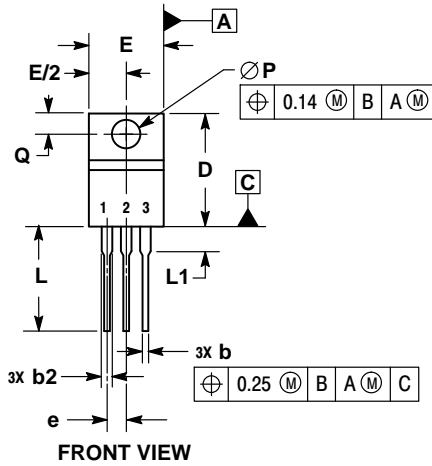

**FRONT VIEW**

**SECTION D-D**

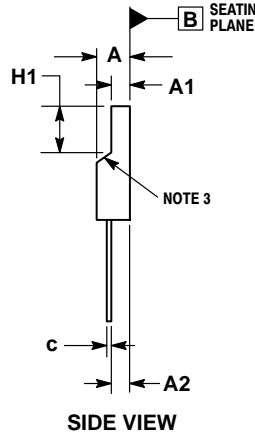

**SIDE VIEW**

NOTES:

1. DIMENSIONING AND TOLERANCING PER ASME Y14.5M, 1994.
2. CONTROLLING DIMENSION: MILLIMETERS.
3. CONTOUR UNCONTROLLED IN THIS AREA.
4. DIMENSIONS D AND E DO NOT INCLUDE MOLD FLASH AND GATE PROTRUSIONS. MOLD FLASH AND GATE PROTRUSIONS NOT TO EXCEED 0.13 PER SIDE. THESE DIMENSIONS ARE TO BE MEASURED AT OUTERMOST EXTREME OF THE PLASTIC BODY.
5. DIMENSION b2 DOES NOT INCLUDE DAMBAR PROTRUSION. LEAD WIDTH INCLUDING PROTRUSION SHALL NOT EXCEED 2.00.
6. CONTOURS AND FEATURES OF THE MOLDED PACKAGE BODY MAY VARY WITHIN THE ENVELOPE DEFINED BY DIMENSIONS A1 AND H1 FOR MANUFACTURING PURPOSES.

DIM	MILLIMETERS	
	MIN	MAX
A	4.30	4.70
A1	2.50	2.90
A2	2.50	2.90
b	0.54	0.84
b2	1.10	1.40
c	0.49	0.79
D	14.70	15.30
E	9.70	10.30
e	2.54 BSC	
H1	6.60	7.10
L	12.50	14.73
L1	---	2.80
P	3.00	3.40
Q	2.80	3.20

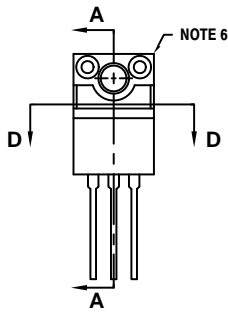

**ALTERNATE CONSTRUCTION**

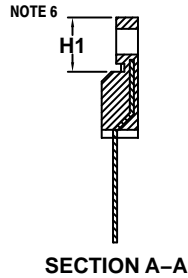

**SECTION A-A**

**NTST20120CTG, NTSJ20120CTG, NTSB20120CT-1G, NTSB20120CTG,  
NTSB20120CTT4G**

**PACKAGE DIMENSIONS**

**D<sup>2</sup>PAK 3**  
CASE 418B-04  
ISSUE K

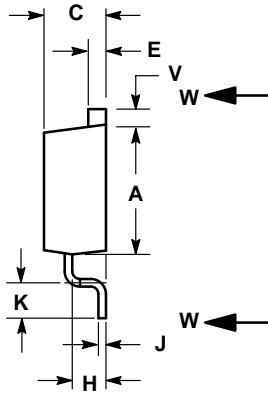
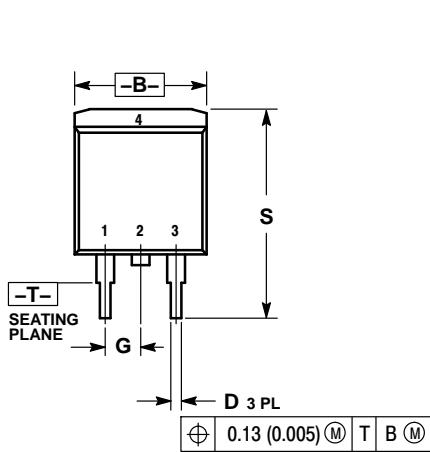

- NOTES:  
 1. DIMENSIONING AND TOLERANCING PER ANSI Y14.5M, 1982.  
 2. CONTROLLING DIMENSION: INCH.  
 3. 418B-01 THRU 418B-03 OBSOLETE, NEW STANDARD 418B-04.

DIM	INCHES		MILLIMETERS	
	MIN	MAX	MIN	MAX
A	0.340	0.380	8.64	9.65
B	0.380	0.405	9.65	10.29
C	0.160	0.190	4.06	4.83
D	0.020	0.035	0.51	0.89
E	0.045	0.055	1.14	1.40
F	0.310	0.350	7.87	8.89
G	0.100 BSC		2.54 BSC	
H	0.080	0.110	2.03	2.79
J	0.018	0.025	0.46	0.64
K	0.090	0.110	2.29	2.79
L	0.052	0.072	1.32	1.83
M	0.280	0.320	7.11	8.13
N	0.197 REF		5.00 REF	
P	0.079 REF		2.00 REF	
R	0.039 REF		0.99 REF	
S	0.575	0.625	14.60	15.88
V	0.045	0.055	1.14	1.40

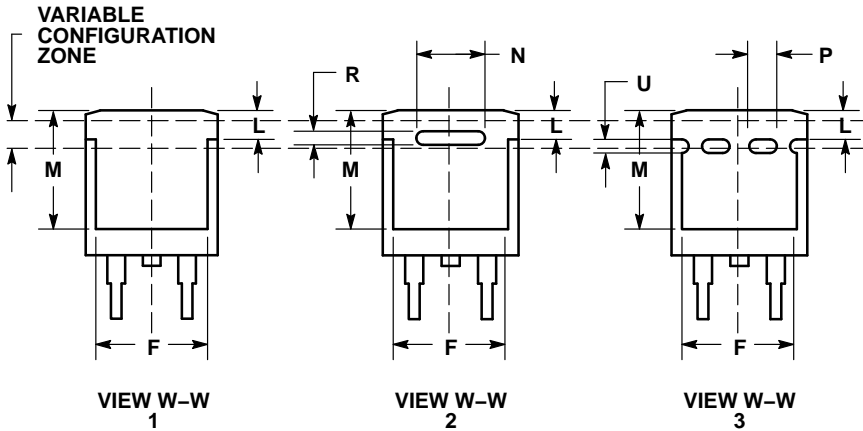



# NTST20120CTG, NTSJ20120CTG, NTSB20120CT-1G, NTSB20120CTG, NTSB20120CTT4G

## PACKAGE DIMENSIONS

I<sup>2</sup>PAK (TO-262)  
CASE 418D  
ISSUE D

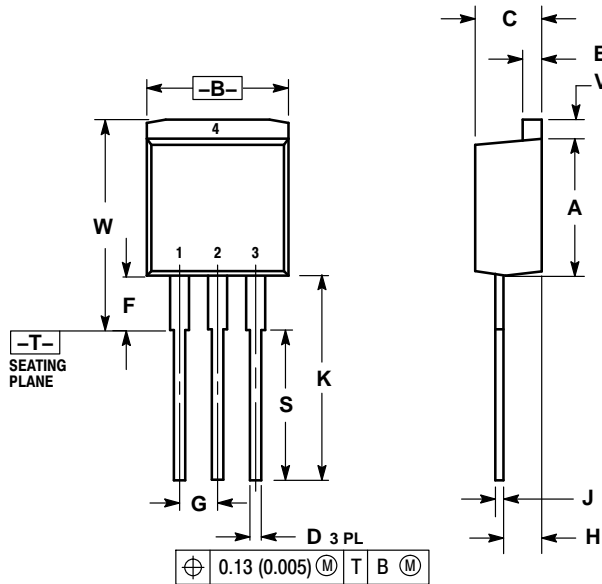

- NOTES:  
1. DIMENSIONING AND TOLERANCING PER ANSI Y14.5M, 1982.  
2. CONTROLLING DIMENSION: INCH.

DIM	INCHES		MILLIMETERS	
	MIN	MAX	MIN	MAX
A	0.335	0.380	8.51	9.65
B	0.380	0.406	9.65	10.31
C	0.160	0.185	4.06	4.70
D	0.026	0.035	0.66	0.89
E	0.045	0.055	1.14	1.40
F	0.122 REF		3.10 REF	
G	0.100 BSC		2.54 BSC	
H	0.094	0.110	2.39	2.79
J	0.013	0.025	0.33	0.64
K	0.500	0.562	12.70	14.27
S	0.390 REF		9.90 REF	
V	0.045	0.070	1.14	1.78
W	0.522	0.551	13.25	14.00

- STYLE 3:  
PIN 1. ANODE  
2. CATHODE  
3. ANODE  
4. CATHODE

ON Semiconductor and are trademarks of Semiconductor Components Industries, LLC dba ON Semiconductor or its subsidiaries in the United States and/or other countries. ON Semiconductor owns the rights to a number of patents, trademarks, copyrights, trade secrets, and other intellectual property. A listing of ON Semiconductor's product/patent coverage may be accessed at [www.onsemi.com/site/pdf/Patent-Marking.pdf](http://www.onsemi.com/site/pdf/Patent-Marking.pdf). ON Semiconductor reserves the right to make changes without further notice to any products herein. ON Semiconductor makes no warranty, representation or guarantee regarding the suitability of its products for any particular purpose, nor does ON Semiconductor assume any liability arising out of the application or use of any product or circuit, and specifically disclaims any and all liability, including without limitation special, consequential or incidental damages. Buyer is responsible for its products and applications using ON Semiconductor products, including compliance with all laws, regulations and safety requirements or standards, regardless of any support or applications information provided by ON Semiconductor. "Typical" parameters which may be provided in ON Semiconductor data sheets and/or specifications can and do vary in different applications and actual performance may vary over time. All operating parameters, including "Typicals" must be validated for each customer application by customer's technical experts. ON Semiconductor does not convey any license under its patent rights nor the rights of others. ON Semiconductor products are not designed, intended, or authorized for use as a critical component in life support systems or any FDA Class 3 medical devices or medical devices with a same or similar classification in a foreign jurisdiction or any devices intended for implantation in the human body. Should Buyer purchase or use ON Semiconductor products for any such unintended or unauthorized application, Buyer shall indemnify and hold ON Semiconductor and its officers, employees, subsidiaries, affiliates, and distributors harmless against all claims, costs, damages, and expenses, and reasonable attorney fees arising out of, directly or indirectly, any claim of personal injury or death associated with such unintended or unauthorized use, even if such claim alleges that ON Semiconductor was negligent regarding the design or manufacture of the part. ON Semiconductor is an Equal Opportunity/Affirmative Action Employer. This literature is subject to all applicable copyright laws and is not for resale in any manner.

### PUBLICATION ORDERING INFORMATION

**LITERATURE FULFILLMENT:**  
Literature Distribution Center for ON Semiconductor  
19521 E. 32nd Pkwy, Aurora, Colorado 80011 USA  
**Phone:** 303-675-2175 or 800-344-3860 Toll Free USA/Canada  
**Fax:** 303-675-2176 or 800-344-3867 Toll Free USA/Canada  
**Email:** [orderlit@onsemi.com](mailto:orderlit@onsemi.com)

**N. American Technical Support:** 800-282-9855 Toll Free  
USA/Canada  
**Europe, Middle East and Africa Technical Support:**  
Phone: 421 33 790 2910  
**Japan Customer Focus Center**  
Phone: 81-3-5817-1050

**ON Semiconductor Website:** [www.onsemi.com](http://www.onsemi.com)  
**Order Literature:** <http://www.onsemi.com/orderlit>  
For additional information, please contact your local  
Sales Representative

# Mouser Electronics

Authorized Distributor

Click to View Pricing, Inventory, Delivery & Lifecycle Information:

[ON Semiconductor:](#)

[NTSB20120CT-1G](#) [NTSB20120CTT4G](#) [NTSJ20120CTG](#) [NTST20120CTG](#)