

NTZD5110N

Small Signal MOSFET 60 V, 310 mA, Dual N-Channel with ESD Protection, SOT-563

Features

- Low $R_{DS(on)}$ Improving System Efficiency
- Low Threshold Voltage
- ESD Protected Gate
- Small Footprint 1.6 x 1.6 mm
- These are Pb-Free Devices

Applications

- Load/Power Switches
- Driver Circuits: Relays, Lamps, Displays, Memories, etc.
- Battery Management/Battery Operated Systems
- Cell Phones, Digital Cameras, PDAs, Pagers, etc.

MAXIMUM RATINGS ($T_J = 25^\circ\text{C}$ unless otherwise noted.)

Parameter		Symbol	Value	Unit	
Drain-to-Source Voltage		V_{DSS}	60	V	
Gate-to-Source Voltage		V_{GS}	± 20	V	
Continuous Drain Current (Note 1)	Steady State	I_D	$T_A = 25^\circ\text{C}$	294	mA
			$T_A = 85^\circ\text{C}$	212	
Power Dissipation (Note 1)	Steady State	P_D	250	mW	
Continuous Drain Current (Note 1)	$t \leq 5 \text{ s}$	I_D	$T_A = 25^\circ\text{C}$	310	mA
			$T_A = 85^\circ\text{C}$	225	
Power Dissipation (Note 1)	$t \leq 5 \text{ s}$	P_D	280	mW	
Pulsed Drain Current	$t_p = 10 \mu\text{s}$	I_{DM}	590	mA	
Operating Junction and Storage Temperature		T_J, T_{STG}	-55 to 150	$^\circ\text{C}$	
Source Current (Body Diode)		I_S	350	mA	
Lead Temperature for Soldering Purposes (1/8" from case for 10 s)		T_L	260	$^\circ\text{C}$	
Gate-Source ESD Rating (HBM, Method 3015)		ESD	1800	V	

THERMAL RESISTANCE RATINGS

Parameter	Symbol	Max	Unit
Junction-to-Ambient - Steady State (Note 1)	$R_{\theta JA}$	500	$^\circ\text{C}/\text{W}$
Junction-to-Ambient - $t \leq 5 \text{ s}$ (Note 1)		447	

Stresses exceeding those listed in the Maximum Ratings table may damage the device. If any of these limits are exceeded, device functionality should not be assumed, damage may occur and reliability may be affected.

1. Surface mounted on FR4 board using 1 in sq pad size (Cu. area = 1.127 in sq [1 oz] including traces).



ON Semiconductor®

<http://onsemi.com>

$V_{(BR)DSS}$	$R_{DS(on)}$ MAX	I_D Max
60	1.6 Ω @ 10 V	310 mA
	2.5 Ω @ 4.5 V	

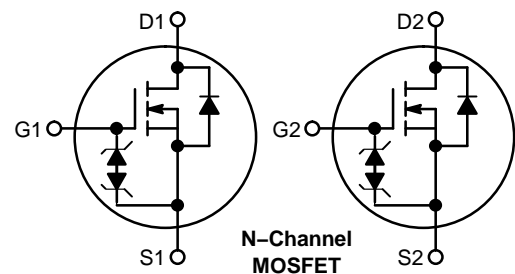

MARKING DIAGRAM

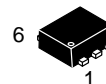

SOT-563
CASE 463A



S7 = Specific Device Code
M = Date Code

(Note: Microdot may be in either location)

PINOUT: SOT-563

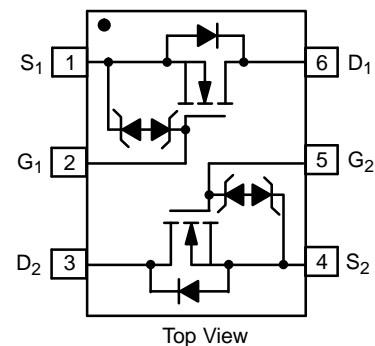

ORDERING INFORMATION

See detailed ordering and shipping information in the package dimensions section on page 4 of this data sheet.

NTZD5110N

ELECTRICAL CHARACTERISTICS (T_J = 25°C unless otherwise noted.)

Parameter	Symbol	Test Condition	Min	Typ	Max	Unit	
OFF CHARACTERISTICS							
Drain-to-Source Breakdown Voltage	V _{(BR)DSS}	V _{GS} = 0 V, I _D = 250 μA	60	–	–	V	
Drain-to-Source Breakdown Voltage Temperature Coefficient	V _{(BR)DSS} /T _J	–	–	71	–	mV/°C	
Zero Gate Voltage Drain Current	I _{DSS}	V _{GS} = 0 V V _{DS} = 60 V	T _J = 25°C	–	–	1.0	μA
			T _J = 125°C	–	–	500	
		V _{GS} = 0 V V _{DS} = 50 V	T _J = 25°C	–	–	100	nA
			T _J = 85°C	–	–	100	
Gate-to-Source Leakage Current	I _{GSS}	V _{DS} = 0 V, V _{GS} = ±20 V	–	–	±10	μA	
		V _{DS} = 0 V, V _{GS} = ±10 V	–	–	450	nA	
		V _{DS} = 0 V, V _{GS} = ±5.0 V	–	–	150	nA	

ON CHARACTERISTICS (Note 3)

Gate Threshold Voltage	V _{GS(TH)}	V _{GS} = V _{DS} , I _D = 250 μA	1.0	–	2.5	V
Negative Threshold Temperature Coefficient	V _{GS(TH)} /T _J	–	–	4.0	–	mV/°C
Drain-to-Source On Resistance	R _{DS(on)}	V _{GS} = 10 V, I _D = 500 mA	–	1.19	1.6	Ω
		V _{GS} = 4.5 V, I _D = 200 mA	–	1.33	2.5	
Forward Transconductance	g _{FS}	V _{DS} = 5.0 V, I _D = 200 mA	–	80	–	S

CHARGES AND CAPACITANCES

Input Capacitance	C _{ISS}	V _{GS} = 0 V, f = 1.0 MHz, V _{DS} = 20 V	–	24.5	–	pF
Output Capacitance	C _{OSS}		–	4.2	–	
Reverse Transfer Capacitance	C _{RSS}		–	2.2	–	
Total Gate Charge	Q _{G(TOT)}	V _{GS} = 4.5 V, V _{DS} = 10 V; I _D = 200 mA	–	0.7	–	nC
Threshold Gate Charge	Q _{G(TH)}		–	0.1	–	
Gate-to-Source Charge	Q _{GS}		–	0.3	–	
Gate-to-Drain Charge	Q _{GD}		–	0.1	–	

SWITCHING CHARACTERISTICS (Note 4)

Turn-On Delay Time	t _{d(ON)}	V _{GS} = 10 V, V _{DD} = 30 V, I _D = 200 mA, R _G = 10 Ω	–	12	–	ns
Rise Time	t _r		–	7.3	–	
Turn-Off Delay Time	t _{d(OFF)}		–	63.7	–	
Fall Time	t _f		–	30.6	–	

DRAIN-SOURCE DIODE CHARACTERISTICS

Forward Diode Voltage	V _{SD}	V _{GS} = 0 V, I _S = 200 mA	T _J = 25°C	–	0.8	1.2	V
			T _J = 85°C	–	0.7	–	

Product parametric performance is indicated in the Electrical Characteristics for the listed test conditions, unless otherwise noted. Product performance may not be indicated by the Electrical Characteristics if operated under different conditions.

2. Surface-mounted on FR4 board using 1 in. sq. pad size (Cu. area = 1.127 in sq [1 oz] including traces).

3. Pulse Test: pulse width ≤ 300 μs, duty cycle ≤ 2%.

4. Switching characteristics are independent of operating junction temperatures.

TYPICAL CHARACTERISTICS

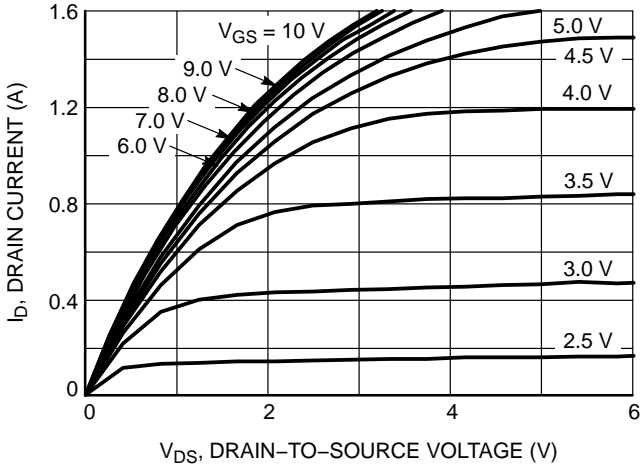

Figure 1. On-Region Characteristics

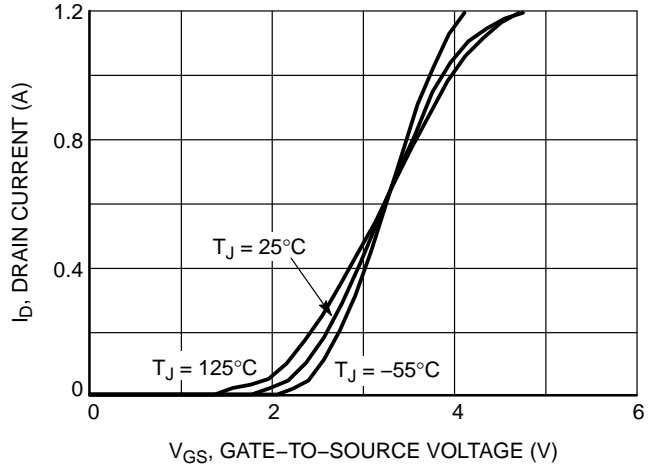

Figure 2. Transfer Characteristics

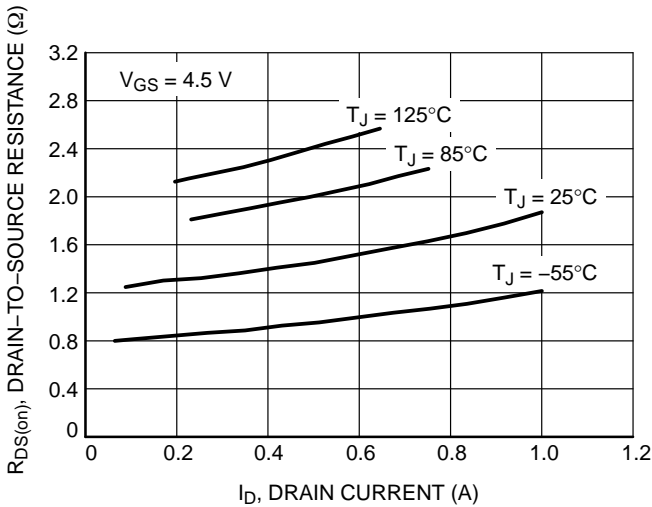

Figure 3. On-Resistance vs. Drain Current and Temperature

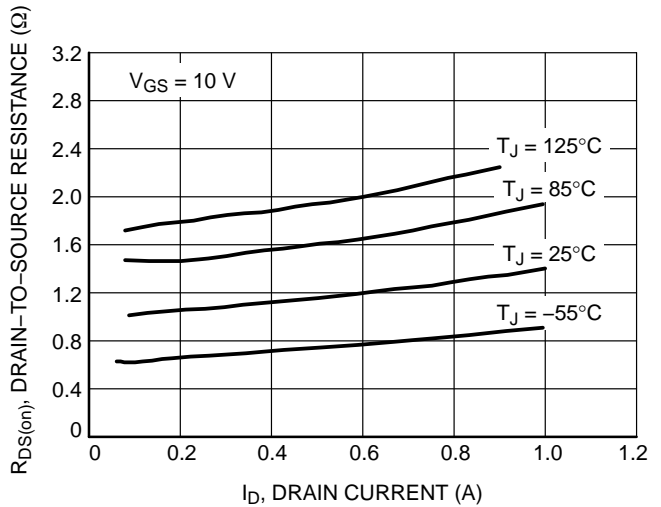

Figure 4. On-Resistance vs. Drain Current and Temperature

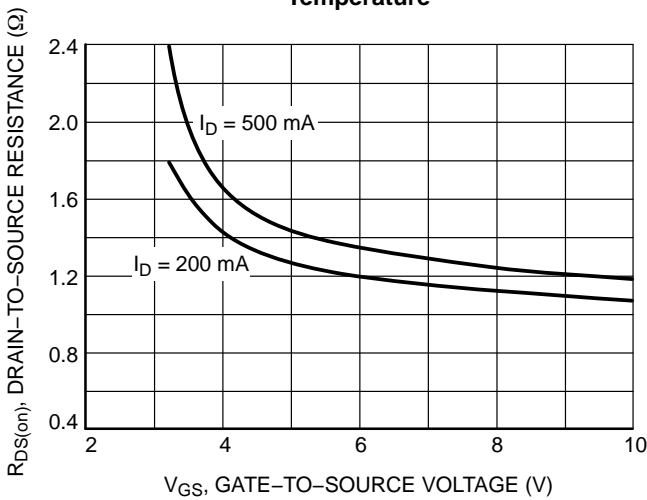

Figure 5. On-Resistance vs. Gate-to-Source Voltage

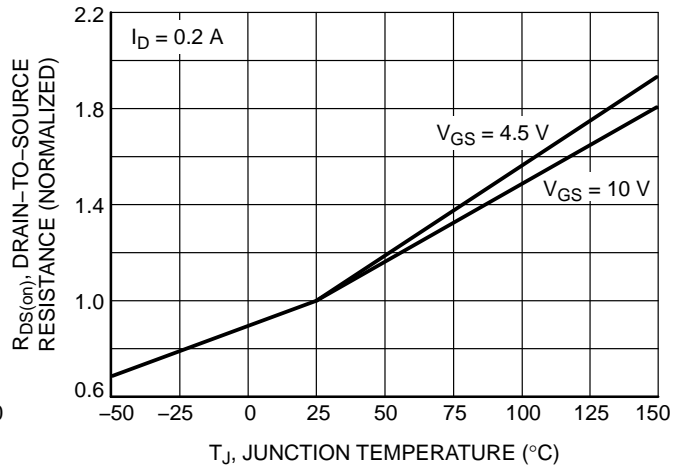

Figure 6. On-Resistance Variation with Temperature

NTZD5110N

TYPICAL CHARACTERISTICS

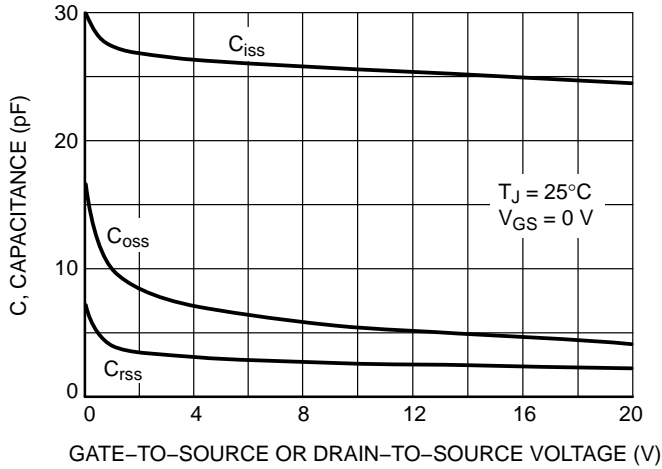

Figure 7. Capacitance Variation

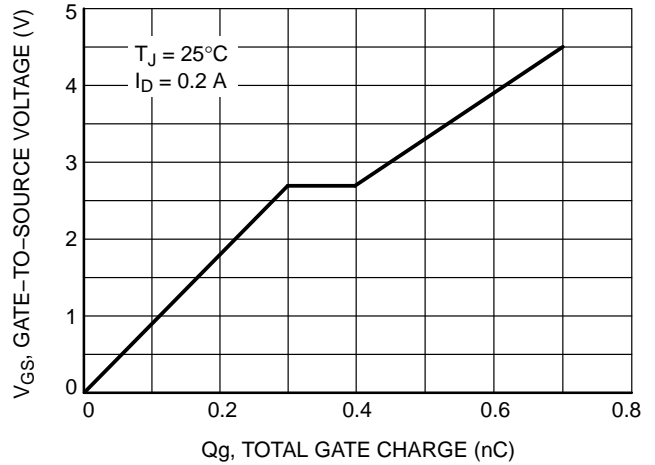

Figure 8. Gate-to-Source and Drain-to-Source Voltage vs. Total Charge

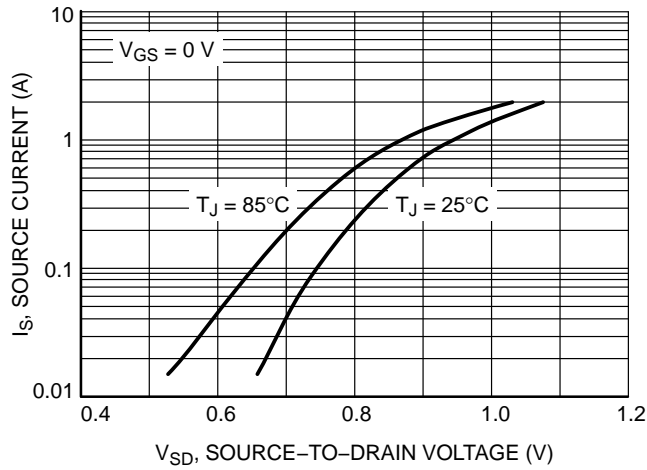

Figure 9. Diode Forward Voltage vs. Current

ORDERING INFORMATION

Device	Package	Shipping
NTZD5110NT1G	SOT-563 (Pb-Free)	4000 / Tape & Reel
NTZD5110NT5G	SOT-563 (Pb-Free)	8000 / Tape & Reel

†For information on tape and reel specifications, including part orientation and tape sizes, please refer to our Tape and Reel Packaging Specifications Brochure, BRD8011/D.

NTZD5110N

PACKAGE DIMENSIONS

SOT-563, 6 LEAD CASE 463A ISSUE F

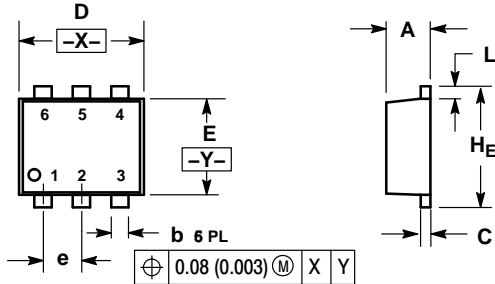

NOTES:

1. DIMENSIONING AND TOLERANCING PER ANSI Y14.5M, 1982.
2. CONTROLLING DIMENSION: MILLIMETERS
3. MAXIMUM LEAD THICKNESS INCLUDES LEAD FINISH THICKNESS. MINIMUM LEAD THICKNESS IS THE MINIMUM THICKNESS OF BASE MATERIAL.

DIM	MILLIMETERS			INCHES		
	MIN	NOM	MAX	MIN	NOM	MAX
A	0.50	0.55	0.60	0.020	0.021	0.023
b	0.17	0.22	0.27	0.007	0.009	0.011
C	0.08	0.12	0.18	0.003	0.005	0.007
D	1.50	1.60	1.70	0.059	0.062	0.066
E	1.10	1.20	1.30	0.043	0.047	0.051
e	0.5 BSC			0.02 BSC		
L	0.10	0.20	0.30	0.004	0.008	0.012
HE	1.50	1.60	1.70	0.059	0.062	0.066

SOLDERING FOOTPRINT*

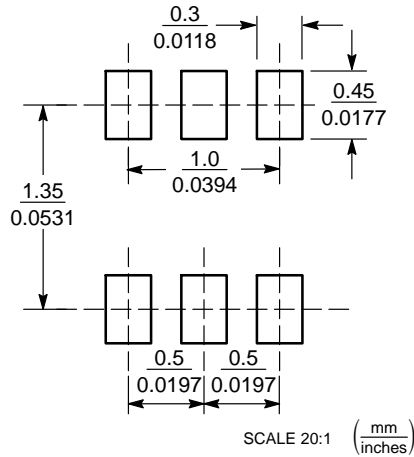

SCALE 20:1 (mm/inches)

*For additional information on our Pb-Free strategy and soldering details, please download the ON Semiconductor Soldering and Mounting Techniques Reference Manual, SOLDERRM/D.

ON Semiconductor and are registered trademarks of Semiconductor Components Industries, LLC (SCILLC). SCILLC owns the rights to a number of patents, trademarks, copyrights, trade secrets, and other intellectual property. A listing of SCILLC's product/patent coverage may be accessed at www.onsemi.com/site/pdf/Patent-Marking.pdf. SCILLC reserves the right to make changes without further notice to any products herein. SCILLC makes no warranty, representation or guarantee regarding the suitability of its products for any particular purpose, nor does SCILLC assume any liability arising out of the application or use of any product or circuit, and specifically disclaims any and all liability, including without limitation special, consequential or incidental damages. "Typical" parameters which may be provided in SCILLC data sheets and/or specifications can and do vary in different applications and actual performance may vary over time. All operating parameters, including "Typicals" must be validated for each customer application by customer's technical experts. SCILLC does not convey any license under its patent rights nor the rights of others. SCILLC products are not designed, intended, or authorized for use as components in systems intended for surgical implant into the body, or other applications intended to support or sustain life, or for any other application in which the failure of the SCILLC product could create a situation where personal injury or death may occur. Should Buyer purchase or use SCILLC products for any such unintended or unauthorized application, Buyer shall indemnify and hold SCILLC and its officers, employees, subsidiaries, affiliates, and distributors harmless against all claims, costs, damages, and expenses, and reasonable attorney fees arising out of, directly or indirectly, any claim of personal injury or death associated with such unintended or unauthorized use, even if such claim alleges that SCILLC was negligent regarding the design or manufacture of the part. SCILLC is an Equal Opportunity/Affirmative Action Employer. This literature is subject to all applicable copyright laws and is not for resale in any manner.

PUBLICATION ORDERING INFORMATION

LITERATURE FULFILLMENT:
Literature Distribution Center for ON Semiconductor
P.O. Box 5163, Denver, Colorado 80217 USA
Phone: 303-675-2175 or 800-344-3860 Toll Free USA/Canada
Fax: 303-675-2176 or 800-344-3867 Toll Free USA/Canada
Email: orderlit@onsemi.com

N. American Technical Support: 800-282-9855 Toll Free
USA/Canada
Europe, Middle East and Africa Technical Support:
Phone: 421 33 790 2910
Japan Customer Focus Center
Phone: 81-3-5817-1050

ON Semiconductor Website: www.onsemi.com
Order Literature: <http://www.onsemi.com/orderlit>
For additional information, please contact your local Sales Representative

Mouser Electronics

Authorized Distributor

Click to View Pricing, Inventory, Delivery & Lifecycle Information:

[ON Semiconductor:](#)

[NTZD5110NT1G](#)