

NUP4302MR6

Schottky Diode Array for Four Data Line ESD Protection

The NUP4302MR6 is designed to protect high speed data line interface from ESD, EFT and lightning.

Features

- Very Low Forward Voltage Drop
- Fast Switching
- PN Junction Guard Ring for Transient and ESD Protection
- ESD Rating of Class 3B (Exceeding 16 kV) per Human Body Model and Class C (Exceeding 400 V) per Machine Model
- IEC 61000-4-2 Level 4 ESD Protection
- Flammability Rating: UL 94 V-0
- Pb-Free Package is Available

Applications

- Ultra High-Speed Switching
- USB 1.1 and 2.0 Power and Data Line Protection
- Digital Video Interface (DVI)
- Monitors and Flat Panel Displays



ON Semiconductor[®]

<http://onsemi.com>

PIN CONFIGURATION AND SCHEMATIC

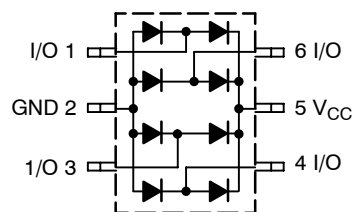

MARKING DIAGRAM



TSOP-6
CASE 318G
STYLE 12

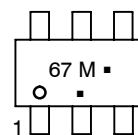

67 = Specific Device Code
M = Date Code
■ = Pb-Free Package

(Note: Microdot may be in either location)

*Date Code orientation may vary depending upon manufacturing location.

ORDERING INFORMATION

Device	Package	Shipping [†]
NUP4302MR6T1	TSOP-6	3000/Tape & Reel
NUP4302MR6T1G	TSOP-6 (Pb-Free)	3000/Tape & Reel

[†]For information on tape and reel specifications, including part orientation and tape sizes, please refer to our Tape and Reel Packaging Specifications Brochure, BRD8011/D.

NUP4302MR6

MAXIMUM RATINGS ($T_J = 25^\circ\text{C}$ unless otherwise noted)

Rating	Symbol	Value	Unit
Peak Reverse Breakdown Voltage	V_{BR}	30	V
Forward Power Dissipation ($T_A = 25^\circ\text{C}$)	P_F	225	mW
Forward Continuous Current	I_F	200	mA
Junction Operating Temperature	T_J	-55 to +125	$^\circ\text{C}$
Storage Temperature Range	T_{stg}	-55 to +150	$^\circ\text{C}$

Stresses exceeding Maximum Ratings may damage the device. Maximum Ratings are stress ratings only. Functional operation above the Recommended Operating Conditions is not implied. Extended exposure to stresses above the Recommended Operating Conditions may affect device reliability.

ELECTRICAL CHARACTERISTICS ($T_J = 25^\circ\text{C}$ unless otherwise noted)

Parameter	Symbol	Conditions	Min	Typ	Max	Unit
Reverse Breakdown Voltage	V_{BR}	$I_R = 100 \mu\text{A}$	30			V
Reverse Leakage	I_R	$V_R = 25 \text{ V}$			30	μA
Forward Voltage	V_F	$I_F = 0.1 \text{ mAdc}$			0.28	V
Forward Voltage	V_F	$I_F = 1.0 \text{ mAdc}$			0.35	V
Forward Voltage	V_F	$I_F = 10 \text{ mAdc}$			0.45	V
Forward Voltage	V_F	$I_F = 100 \text{ mAdc}$			1.00	V
Total Capacitance	C_T	$V_R = 0 \text{ V}, f = 1.0 \text{ MHz}, \text{I/O to Ground}$ $V_R = 0 \text{ V}, f = 1.0 \text{ MHz}, \text{I/O to I/O}$			28 18	pF
Reverse Recovery Time	t_{rr}	$I_F = I_R = 10 \text{ mA}, I_{R(\text{REC})} = 1.0 \text{ mA}$ (Figure 1)			5.0	ns

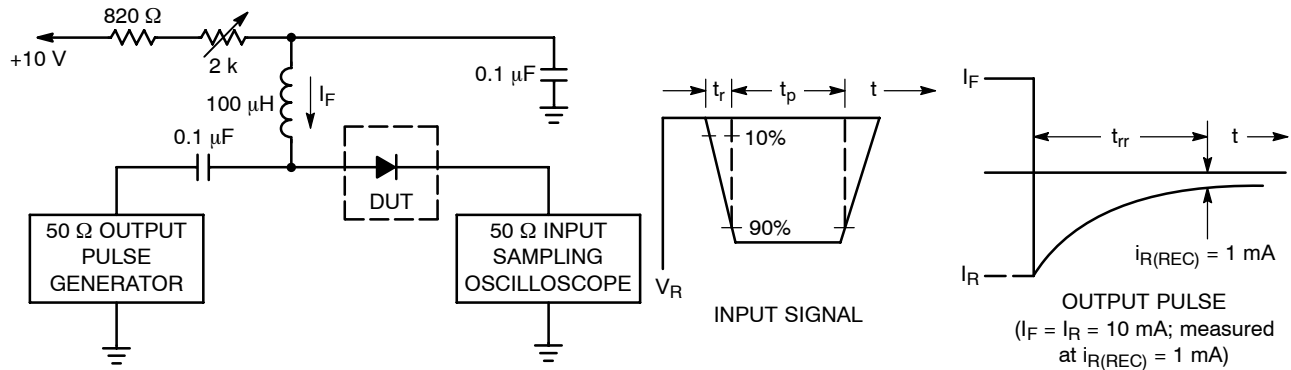

- Notes: 1. A 2.0 k Ω variable resistor adjusted for a Forward Current (I_F) of 10 mA.
 2. Input pulse is adjusted so $I_{R(\text{peak})}$ is equal to 10 mA.
 3. $t_p \gg t_{rr}$

Figure 1. Recovery Time Equivalent Test Circuit

NUP4302MR6

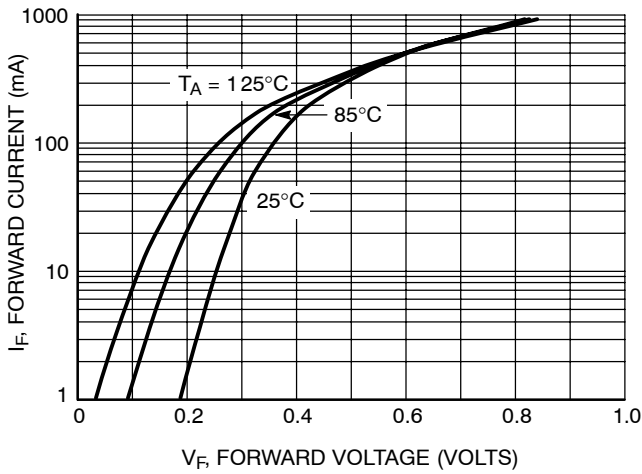

Figure 2. Forward Current as a Function of Forward Voltage; Typical Values

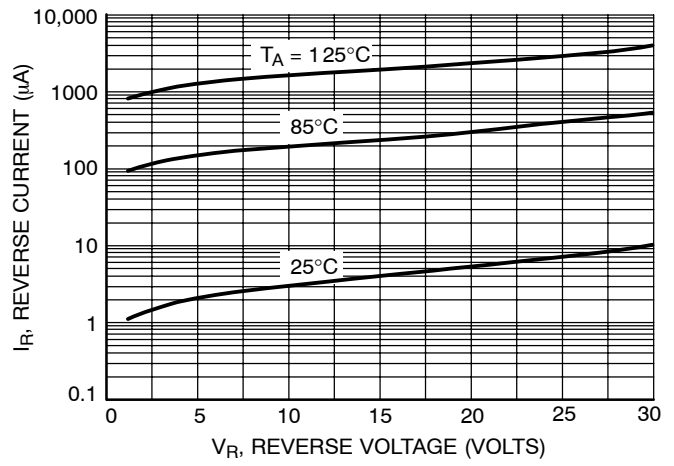

Figure 3. Reverse Current as a Function of Reverse Voltage; Typical Values

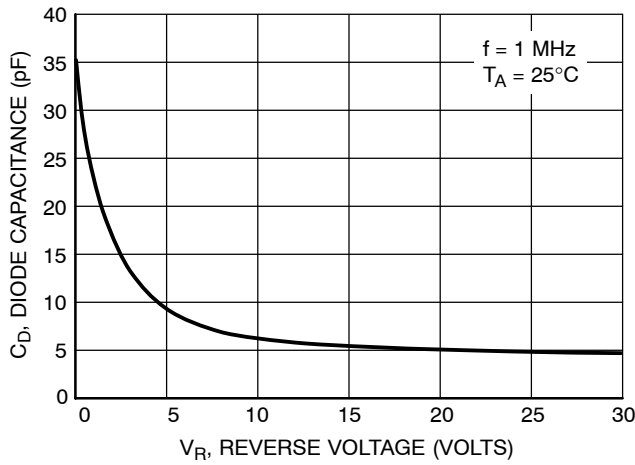
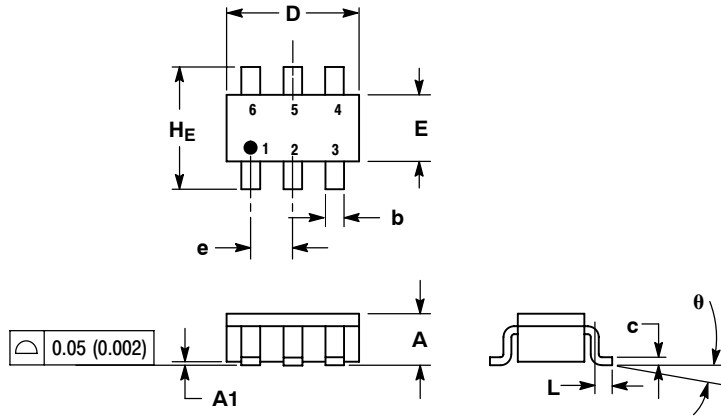

Figure 4. Diode Capacitance as a Function of Reverse Voltage; Typical Values

NUP4302MR6

PACKAGE DIMENSIONS

TSOP-6
CASE 318G-02
ISSUE P



NOTES:

1. DIMENSIONING AND TOLERANCING PER ANSI Y14.5M, 1982.
2. CONTROLLING DIMENSION: MILLIMETER.
3. MAXIMUM LEAD THICKNESS INCLUDES LEAD FINISH THICKNESS. MINIMUM LEAD THICKNESS IS THE MINIMUM THICKNESS OF BASE MATERIAL.
4. DIMENSIONS A AND B DO NOT INCLUDE MOLD FLASH, PROTRUSIONS, OR GATE BURRS.

DIM	MILLIMETERS			INCHES		
	MIN	NOM	MAX	MIN	NOM	MAX
A	0.90	1.00	1.10	0.035	0.039	0.043
A1	0.01	0.06	0.10	0.001	0.002	0.004
b	0.25	0.38	0.50	0.010	0.014	0.020
c	0.10	0.18	0.26	0.004	0.007	0.010
D	2.90	3.00	3.10	0.114	0.118	0.122
E	1.30	1.50	1.70	0.051	0.059	0.067
e	0.85	0.95	1.05	0.034	0.037	0.041
L	0.20	0.40	0.60	0.008	0.016	0.024
HE	2.50	2.75	3.00	0.099	0.108	0.118
θ	0°	-	10°	0°	-	10°

STYLE 12:

1. I/O
2. GROUND
3. I/O
4. I/O
5. VCC
6. I/O

SOLDERING FOOTPRINT*

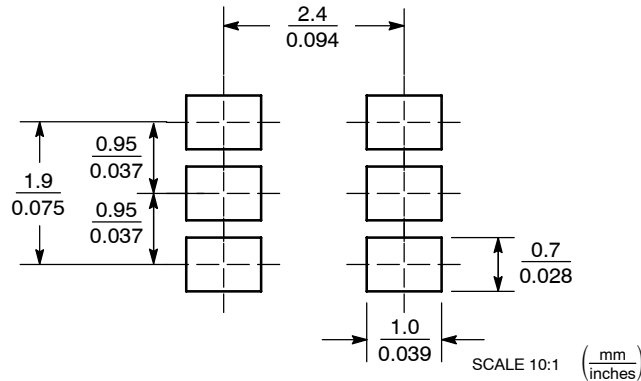

*For additional information on our Pb-Free strategy and soldering details, please download the ON Semiconductor Soldering and Mounting Techniques Reference Manual, SOLDERRM/D.

ON Semiconductor and are registered trademarks of Semiconductor Components Industries, LLC (SCILLC). SCILLC reserves the right to make changes without further notice to any products herein. SCILLC makes no warranty, representation or guarantee regarding the suitability of its products for any particular purpose, nor does SCILLC assume any liability arising out of the application or use of any product or circuit, and specifically disclaims any and all liability, including without limitation special, consequential or incidental damages. "Typical" parameters which may be provided in SCILLC data sheets and/or specifications can and do vary in different applications and actual performance may vary over time. All operating parameters, including "Typicals" must be validated for each customer application by customer's technical experts. SCILLC does not convey any license under its patent rights nor the rights of others. SCILLC products are not designed, intended, or authorized for use as components in systems intended for surgical implant into the body, or other applications intended to support or sustain life, or for any other application in which the failure of the SCILLC product could create a situation where personal injury or death may occur. Should Buyer purchase or use SCILLC products for any such unintended or unauthorized application, Buyer shall indemnify and hold SCILLC and its officers, employees, subsidiaries, affiliates, and distributors harmless against all claims, costs, damages, and expenses, and reasonable attorney fees arising out of, directly or indirectly, any claim of personal injury or death associated with such unintended or unauthorized use, even if such claim alleges that SCILLC was negligent regarding the design or manufacture of the part. SCILLC is an Equal Opportunity/Affirmative Action Employer. This literature is subject to all applicable copyright laws and is not for resale in any manner.

PUBLICATION ORDERING INFORMATION

LITERATURE FULFILLMENT:
Literature Distribution Center for ON Semiconductor
P.O. Box 61312, Phoenix, Arizona 85082-1312 USA
Phone: 480-829-7710 or 800-344-3860 Toll Free USA/Canada
Fax: 480-829-7709 or 800-344-3867 Toll Free USA/Canada
Email: orderlit@onsemi.com

N. American Technical Support: 800-282-9855 Toll Free
USA/Canada

Japan: ON Semiconductor, Japan Customer Focus Center
2-9-1 Kamimeguro, Meguro-ku, Tokyo, Japan 153-0051
Phone: 81-3-5773-3850

ON Semiconductor Website: <http://onsemi.com>

Order Literature: <http://www.onsemi.com/litorder>

For additional information, please contact your local Sales Representative.

Mouser Electronics

Authorized Distributor

Click to View Pricing, Inventory, Delivery & Lifecycle Information:

[ON Semiconductor:](#)

[NUP4302MR6T1G](#)