

# NTR4501N, NVR4501N

## Power MOSFET

20 V, 3.2 A, Single N-Channel, SOT-23



ON Semiconductor®

<http://onsemi.com>

### Features

- Leading Planar Technology for Low Gate Charge / Fast Switching
- 2.5 V Rated for Low Voltage Gate Drive
- SOT-23 Surface Mount for Small Footprint
- NVR Prefix for Automotive and Other Applications Requiring Unique Site and Control Change Requirements; AEC-Q101 Qualified and PPAP Capable
- These Devices are Pb-Free and are RoHS Compliant

### Applications

- Load/Power Switch for Portables
- Load/Power Switch for Computing
- DC-DC Conversion

### MAXIMUM RATINGS (T<sub>J</sub> = 25°C unless otherwise stated)

Parameter		Symbol	Value	Unit	
Drain-to-Source Voltage		V <sub>DSS</sub>	20	V	
Gate-to-Source Voltage		V <sub>GS</sub>	±12	V	
Continuous Drain Current (Note 1)	Steady State	I <sub>D</sub>	T <sub>A</sub> = 25°C	3.2	A
			T <sub>A</sub> = 85°C	2.4	A
Steady State Power Dissipation (Note 1)	Steady State	P <sub>D</sub>	1.25	W	
Pulsed Drain Current	t <sub>p</sub> = 10 μs	I <sub>DM</sub>	10.0	A	
Operating Junction and Storage Temperature		T <sub>J</sub> , T <sub>stg</sub>	-55 to 150	°C	
Continuous Source Current (Body Diode)		I <sub>S</sub>	1.6	A	
Lead Temperature for Soldering Purposes (1/8" from case for 10 s)		T <sub>L</sub>	260	°C	

### THERMAL RESISTANCE RATINGS

Parameter	Symbol	Max	Unit
Junction-to-Ambient (Note 1)	R <sub>θJA</sub>	100	°C/W
Junction-to-Ambient (Note 2)	R <sub>θJA</sub>	300	

Stresses exceeding Maximum Ratings may damage the device. Maximum Ratings are stress ratings only. Functional operation above the Recommended Operating Conditions is not implied. Extended exposure to stresses above the Recommended Operating Conditions may affect device reliability.

1. Surface-mounted on FR4 board using 1 in sq pad size (Cu area = 1.127 in sq [1 oz] including traces).
2. Surface-mounted on FR4 board using the minimum recommended pad size.

V <sub>(BR)DSS</sub>	R <sub>DS(on) Typ</sub>	I <sub>D Max</sub> (Note 1)
20 V	70 mΩ @ 4.5 V	3.6 A
	88 mΩ @ 2.5 V	3.1 A

### N-Channel

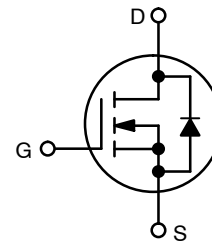

### MARKING DIAGRAM & PIN ASSIGNMENT

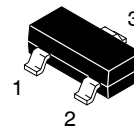

**SOT-23  
CASE 318  
STYLE 21**

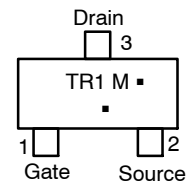

TR1 = Device Code  
M = Date Code\*  
▪ = Pb-Free Package

(Note: Microdot may be in either location)

\*Date Code orientation and/or overbar may vary depending upon manufacturing location.

### ORDERING INFORMATION

Device	Package	Shipping†
NTR4501NT1G	SOT-23 (Pb-Free)	3000 / Tape & Reel
NVR4501NT1G	SOT-23 (Pb-Free)	3000 / Tape & Reel

†For information on tape and reel specifications, including part orientation and tape sizes, please refer to our Tape and Reel Packaging Specifications Brochure, BRD8011/D.

# NTR4501N, NVR4501N

## Electrical Characteristics (T<sub>J</sub> = 25°C unless otherwise specified)

Parameter	Symbol	Test Condition	Min	Typ	Max	Units
<b>OFF CHARACTERISTICS</b>						
Drain-to-Source Breakdown Voltage (Note 3)	V <sub>(BR)DSS</sub>	V <sub>GS</sub> = 0 V, I <sub>D</sub> = 250 μA	20	24.5		V
Drain-to-Source Breakdown Voltage Temperature Coefficient	V <sub>(BR)DSS</sub> /T <sub>J</sub>			22		mV/°C
Zero Gate Voltage Drain Current	I <sub>DSS</sub>	V <sub>GS</sub> = 0 V, T <sub>J</sub> = 25°C			1.5	μA
		V <sub>DS</sub> = 16 V, T <sub>J</sub> = 85°C			10	μA
Gate-to-Source Leakage Current	I <sub>GSS</sub>	V <sub>DS</sub> = 0 V, V <sub>GS</sub> = ±12 V			±100	nA

## ON CHARACTERISTICS

Gate Threshold Voltage (Note 3)	V <sub>GS(TH)</sub>	V <sub>GS</sub> = V <sub>DS</sub> , I <sub>D</sub> = 250 μA	0.65		1.2	V
Negative Threshold Temperature Coefficient	V <sub>GS(TH)</sub> /T <sub>J</sub>			-2.3		mV/°C
Drain-to-Source On Resistance	R <sub>DS(on)</sub>	V <sub>GS</sub> = 4.5 V, I <sub>D</sub> = 3.6 A		70	80	mΩ
		V <sub>GS</sub> = 2.5 V, I <sub>D</sub> = 3.1 A		88	105	
Forward Transconductance	g <sub>FS</sub>	V <sub>DS</sub> = 5.0 V, I <sub>D</sub> = 3.6 A		9		S

## CHARGES AND CAPACITANCES

Input Capacitance	C <sub>iss</sub>	V <sub>GS</sub> = 0 V, f = 1.0 MHz, V <sub>DS</sub> = 10 V		200		pF
Output Capacitance	C <sub>oss</sub>			80		
Reverse Transfer Capacitance	C <sub>rss</sub>			50		
Total Gate Charge	Q <sub>G(TOT)</sub>	V <sub>GS</sub> = 4.5 V, V <sub>DS</sub> = 10 V, I <sub>D</sub> = 3.6 A		2.4	6.0	nC
Gate-to-Source Gate Charge	Q <sub>GS</sub>			0.5		
Gate-to-Drain Charge	Q <sub>GD</sub>			0.6		

## SWITCHING CHARACTERISTICS (Note 4)

Turn-On Delay Time	t <sub>d(on)</sub>	V <sub>GS</sub> = 4.5 V, V <sub>DS</sub> = 10 V, I <sub>D</sub> = 3.6 A, R <sub>G</sub> = 6.0 Ω		6.5	13	ns
Rise Time	t <sub>r</sub>			12	24	
Turn-Off Delay Time	t <sub>d(off)</sub>			12	24	
Fall Time	t <sub>f</sub>			3	6	

## SOURCE-DRAIN DIODE CHARACTERISTICS

Forward Diode Voltage	V <sub>SD</sub>	V <sub>GS</sub> = 0 V, I <sub>SD</sub> = 1.6 A		0.8	1.2	V
Reverse Recovery Time	t <sub>RR</sub>	V <sub>GS</sub> = 0 V, dI <sub>S</sub> /dt = 100 A/μs, I <sub>S</sub> = 1.6 A		7.1		ns
Charge Time	t <sub>a</sub>			5		
Discharge Time	t <sub>b</sub>			1.9		
Reverse Recovery Charge	Q <sub>RR</sub>			3.0		nC

3. Pulse Test: Pulse width ≤ 300 μs, duty cycle ≤ 2%.

4. Switching characteristics are independent of operating junction temperatures.

# NTR4501N, NVR4501N

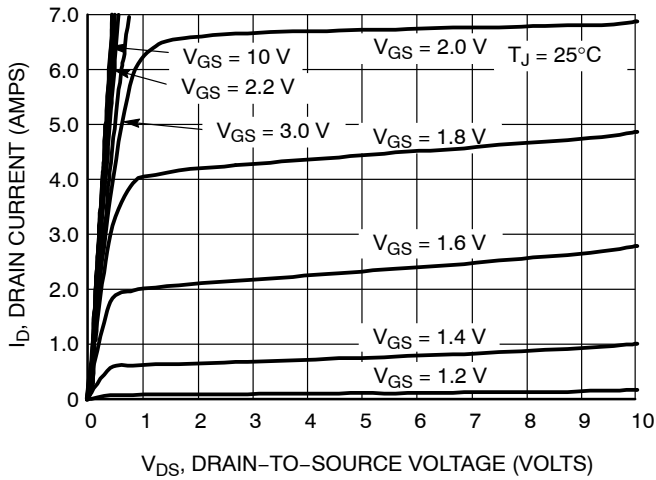

**Figure 1. On-Region Characteristics**

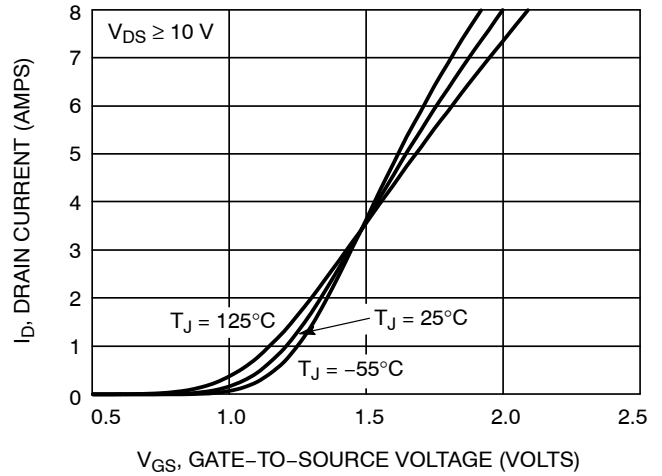

**Figure 2. Transfer Characteristics**

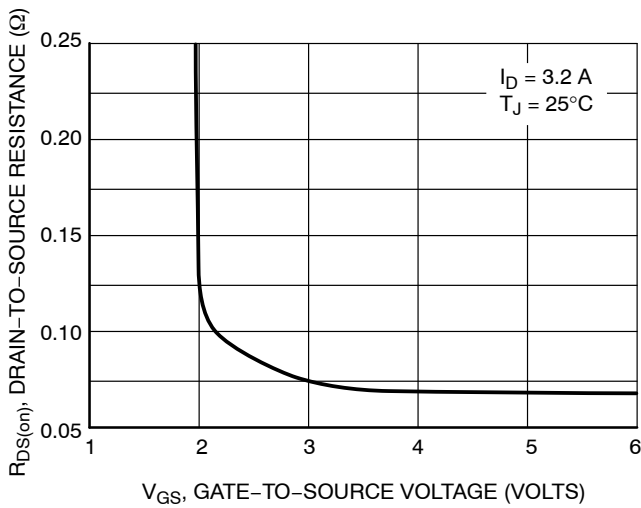

**Figure 3. On-Resistance versus Gate-to-Source Voltage**

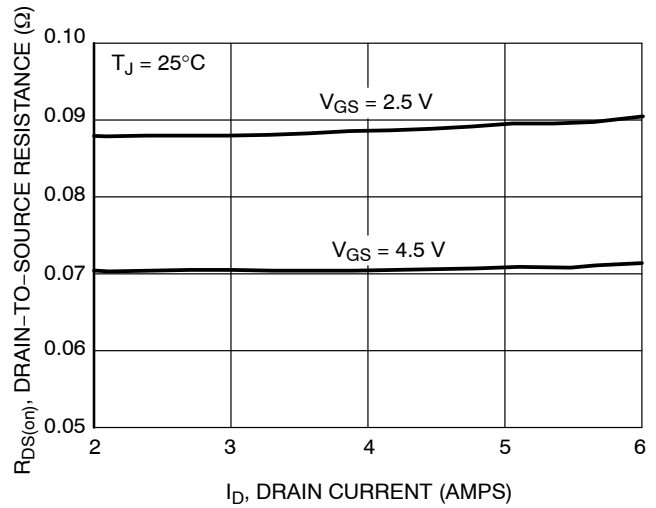

**Figure 4. On-Resistance versus Drain Current and Gate Voltage**

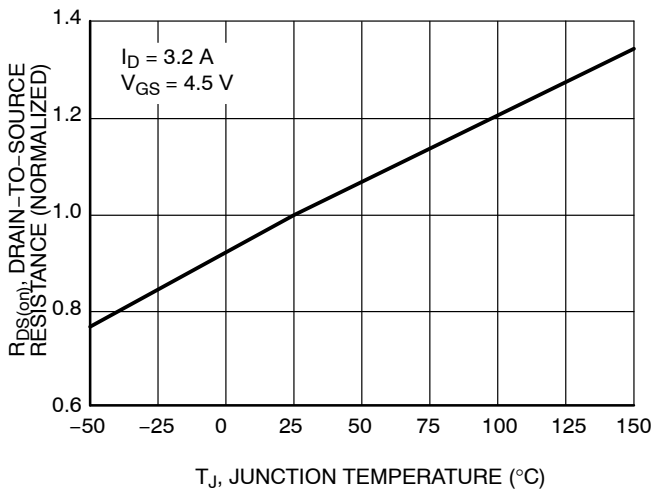

**Figure 5. On-Resistance Variation with Temperature**

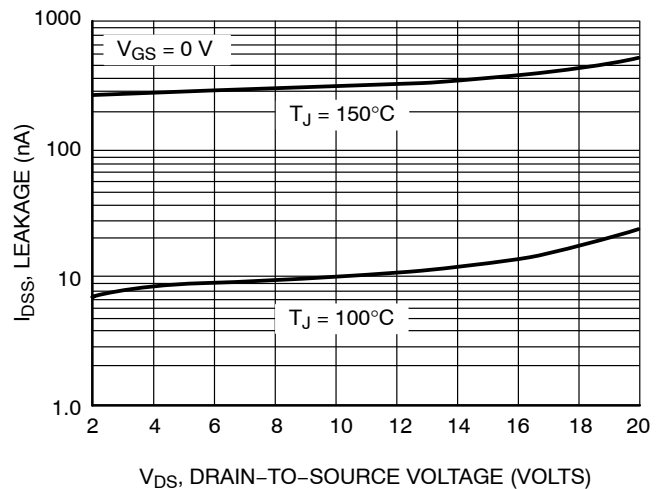

**Figure 6. Drain-to-Source Leakage Current versus Voltage**

# NTR4501N, NVR4501N

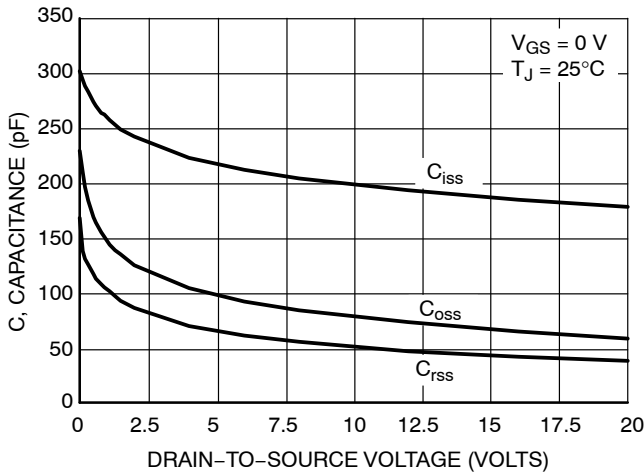

Figure 7. Capacitance Variation

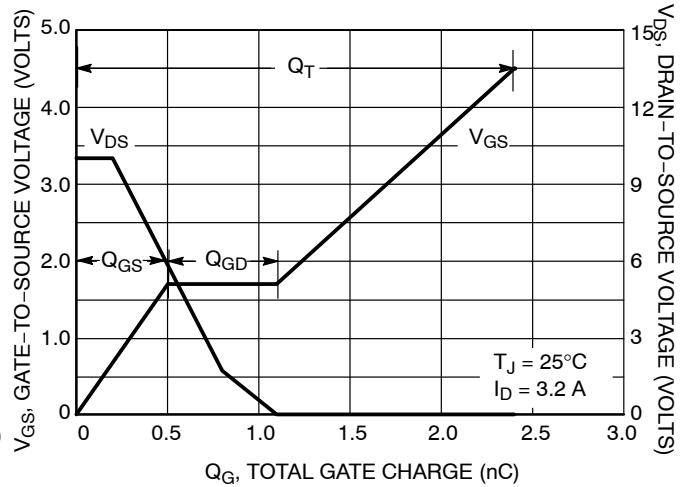

Figure 8. Gate-to-Source and Drain-to-Source Voltage versus Total Charge

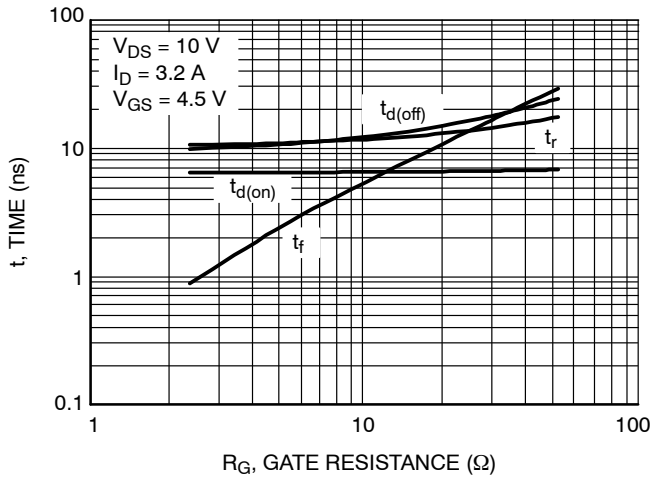

Figure 9. Resistive Switching Time Variation versus Gate Resistance

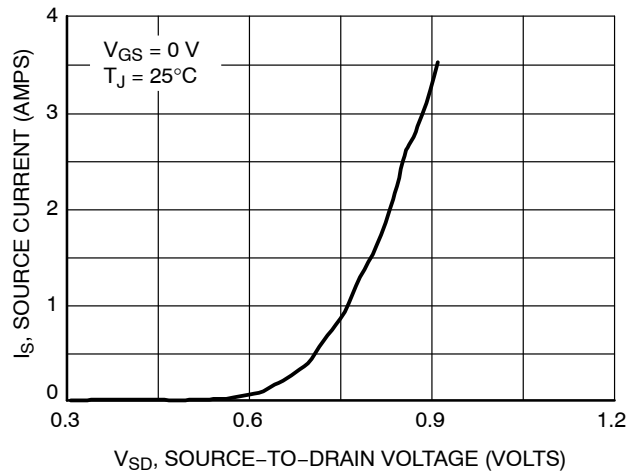

Figure 10. Diode Forward Voltage versus Current

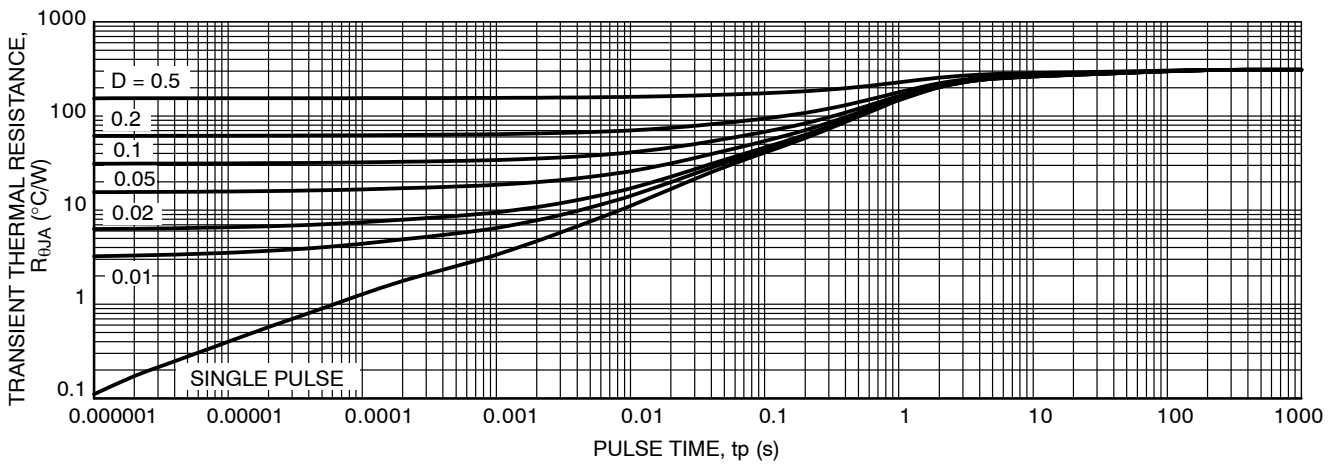
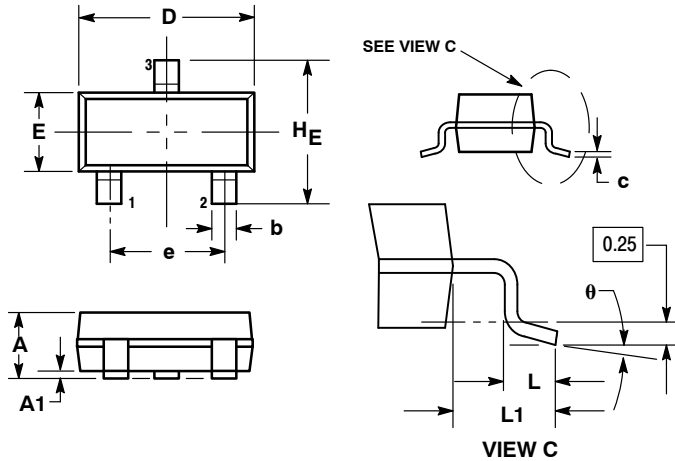

Figure 11. Thermal Response

# NTR4501N, NVR4501N

## PACKAGE DIMENSIONS

SOT-23 (TO-236)  
CASE 318-08  
ISSUE AP



NOTES:

1. DIMENSIONING AND TOLERANCING PER ANSI Y14.5M, 1982.
2. CONTROLLING DIMENSION: INCH.
3. MAXIMUM LEAD THICKNESS INCLUDES LEAD FINISH THICKNESS. MINIMUM LEAD THICKNESS IS THE MINIMUM THICKNESS OF BASE MATERIAL.
4. DIMENSIONS D AND E DO NOT INCLUDE MOLD FLASH, PROTRUSIONS, OR GATE BURRS.

DIM	MILLIMETERS			INCHES		
	MIN	NOM	MAX	MIN	NOM	MAX
A	0.89	1.00	1.11	0.035	0.040	0.044
A1	0.01	0.06	0.10	0.001	0.002	0.004
b	0.37	0.44	0.50	0.015	0.018	0.020
c	0.09	0.13	0.18	0.003	0.005	0.007
D	2.80	2.90	3.04	0.110	0.114	0.120
E	1.20	1.30	1.40	0.047	0.051	0.055
e	1.78	1.90	2.04	0.070	0.075	0.081
L	0.10	0.20	0.30	0.004	0.008	0.012
L1	0.35	0.54	0.69	0.014	0.021	0.029
HE	2.10	2.40	2.64	0.083	0.094	0.104
θ	0°	---	10°	0°	---	10°

STYLE 21:

1. GATE
2. SOURCE
3. DRAIN

### SOLDERING FOOTPRINT

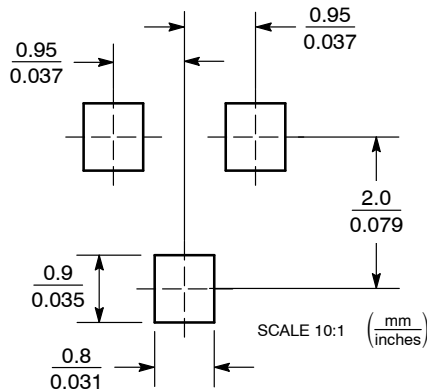

\*For additional information on our Pb-Free strategy and soldering details, please download the ON Semiconductor Soldering and Mounting Techniques Reference Manual, SOLDERRM/D.

ON Semiconductor and are registered trademarks of Semiconductor Components Industries, LLC (SCILLC). SCILLC owns the rights to a number of patents, trademarks, copyrights, trade secrets, and other intellectual property. A listing of SCILLC's product/patent coverage may be accessed at [www.onsemi.com/site/pdf/Patent-Marking.pdf](http://www.onsemi.com/site/pdf/Patent-Marking.pdf). SCILLC reserves the right to make changes without further notice to any products herein. SCILLC makes no warranty, representation or guarantee regarding the suitability of its products for any particular purpose, nor does SCILLC assume any liability arising out of the application or use of any product or circuit, and specifically disclaims any and all liability, including without limitation special, consequential or incidental damages. "Typical" parameters which may be provided in SCILLC data sheets and/or specifications can and do vary in different applications and actual performance may vary over time. All operating parameters, including "Typicals" must be validated for each customer application by customer's technical experts. SCILLC does not convey any license under its patent rights nor the rights of others. SCILLC products are not designed, intended, or authorized for use as components in systems intended for surgical implant into the body, or other applications intended to support or sustain life, or for any other application in which the failure of the SCILLC product could create a situation where personal injury or death may occur. Should Buyer purchase or use SCILLC products for any such unintended or unauthorized application, Buyer shall indemnify and hold SCILLC and its officers, employees, subsidiaries, affiliates, and distributors harmless against all claims, costs, damages, and expenses, and reasonable attorney fees arising out of, directly or indirectly, any claim of personal injury or death associated with such unintended or unauthorized use, even if such claim alleges that SCILLC was negligent regarding the design or manufacture of the part. SCILLC is an Equal Opportunity/Affirmative Action Employer. This literature is subject to all applicable copyright laws and is not for resale in any manner.

### PUBLICATION ORDERING INFORMATION

**LITERATURE FULFILLMENT:**  
Literature Distribution Center for ON Semiconductor  
P.O. Box 5163, Denver, Colorado 80217 USA  
**Phone:** 303-675-2175 or 800-344-3860 Toll Free USA/Canada  
**Fax:** 303-675-2176 or 800-344-3867 Toll Free USA/Canada  
**Email:** [orderlit@onsemi.com](mailto:orderlit@onsemi.com)

**N. American Technical Support:** 800-282-9855 Toll Free  
USA/Canada  
**Europe, Middle East and Africa Technical Support:**  
Phone: 421 33 790 2910  
**Japan Customer Focus Center**  
Phone: 81-3-5817-1050

**ON Semiconductor Website:** [www.onsemi.com](http://www.onsemi.com)  
**Order Literature:** <http://www.onsemi.com/orderlit>  
For additional information, please contact your local Sales Representative

# Mouser Electronics

Authorized Distributor

Click to View Pricing, Inventory, Delivery & Lifecycle Information:

[ON Semiconductor:](#)

[NTR4501NT1](#) [NTR4501NT1G](#) [NTR4501NT3](#) [NTR4501NT3G](#)