

## Alternator voltage regulator

### Features

- For air and liquid cooled applications
- Ambient air temperature (thermistor) compensated
- Special default compensation curve with TS-terminal open
- Compensation curve with application specific resistor on TS
- Thermal protection
- Field driver, lamp driver, relay driver, and df (field monitor) short circuit protected
- Load response control
- Single phase autostart

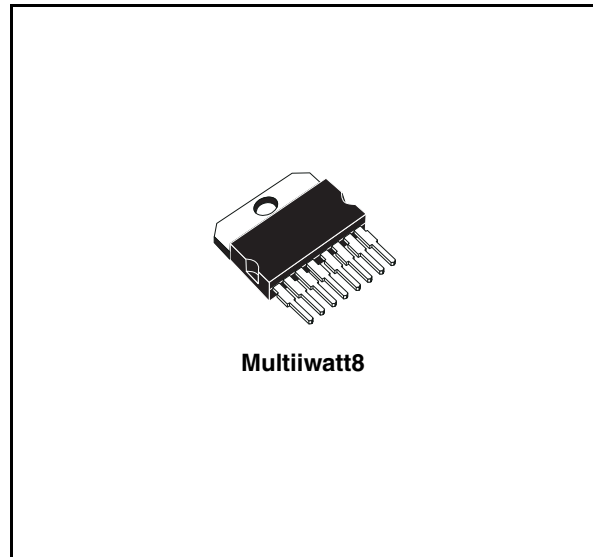

### Description

The L9484 is a monolithic multifunction alternator voltage regulator intended for use in automotive charging applications.

L9484 regulates the output of an automotive generator by controlling the field winding current by means of a variable frequency PWM high side driver.

**Table 1. Device summary**

Order code	Package	Packing
L9484	Multiwatt8	Tube

---

# Contents

<b>1</b>	<b>Pin description</b> .....	<b>3</b>
<b>2</b>	<b>Electrical specification</b> .....	<b>4</b>
2.1	Absolute maximum ratings .....	4
2.2	Thermal data .....	4
2.3	Electrical characteristics .....	4
2.4	Diagnostic .....	7
2.5	Fault indication .....	7
2.6	Regulation features .....	7
<b>3</b>	<b>Package information</b> .....	<b>9</b>
<b>4</b>	<b>Revision history</b> .....	<b>10</b>

# 1 Pin description

**Table 2. Pin description**

N #	Pin	Description
1	V <sub>GO</sub>	Generator output – voltage sense and power supply to ASVR
2	F+	Field driver - high side drive output
3	G	Ground for ASVR (must be connected for ground for ASVR)
4	TS	Thermistor sense terminal
5	Gnd	Internally connected to the tab or slug in MW-8. Shall not be used for ASVR ground, nor voltage applied to pin 5 to cause ≥ 50mV pin 5 to pin 3. May be unconnected or externally connected to pin 3.
6	DF	Inverted field monitor output
7	L	Lamp - low side driver; relay - high side driver
8	P	Phase sense input

**Figure 1. Pin connection (top view)**

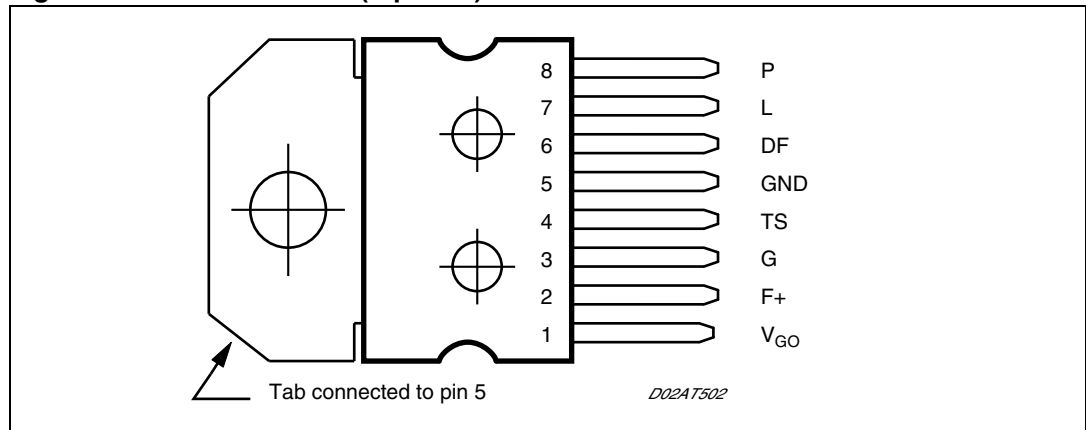

## 2 Electrical specification

### 2.1 Absolute maximum ratings

Table 3. Absolute maximum ratings

Symbol	Parameter	Value	Unit
$I_o$	Output current capability	Internally limited	A
$P_{tot}$	Power dissipation	6	W
	Short circuit protected	All terminal, to VGO and ground	

### 2.2 Thermal data

Table 4. Thermal data

Symbol	Parameter	Value	Unit
$T_j$	Junction temperature	-40 to +150	°C
$T_{stg}$	Storage temperature	-50 to +150	°C
$T_{sd}$	Thermal shut-down	175 ± 15	°C
$R_{th\ j-case}$	Thermal resistance junction to case	1.5	°C/W

### 2.3 Electrical characteristics

Table 5. Electrical characteristics

( $T_{case} = -35^{\circ}\text{C}$  to  $+150^{\circ}\text{C}$  continuous unless otherwise specified)

Symbol	Parameter	Test condition	Min.	Typ.	Max.	Unit
$V_{OS}$	Operating supply voltage	$T_{case} = +25^{\circ}\text{C}$ to $+150^{\circ}\text{C}$	8		$V_{ov}$	V
$V_{OS}$	Operating supply voltage	$T_{case} = -40^{\circ}\text{C}$ to $+25^{\circ}\text{C}$	10		$V_{ov}$	V
$I_{SB}$	Stand-by current	$V_{GO} = 12.6\text{V}$ ; $T_{case} = 25^{\circ}\text{C}$ ; $10\text{k}\Omega$ $V_{GO}$ to TS; F+, G & tab (slug) grounded; L, DF, & P unconnected; regulator not activated.			300	$\mu\text{A}$
$V_{SP}$	Regulator set-point	$10\text{k}\Omega$ between $V_{GO}$ and TS	Curve shown in <a href="#">Figure 3</a>			
$V_{SP}$	Regulator set-point	NTC thermistor with $R_{25^{\circ}\text{C}} = 10\text{k}\Omega$ ; $T_j = 90^{\circ}\text{C}$	Curves shown in <a href="#">Figure 4</a> (with MURATA NTC NTH4G39A1)			
$V_{NB}$	Generator output, no battery	No battery, $I_{OUT} = 2\text{A}$ to 50% max. load	$V_{SP} - 2$		$V_{SP} + 2$	V
$T_C$	Thermal compensation	voltage @ $V_{GO}$	Curves shown in <a href="#">Figure 3</a> and <a href="#">Figure 4</a>			

**Table 5. Electrical characteristics (continued)**  
 ( $T_{case} = -35^{\circ}C$  to  $+150^{\circ}C$  continuous unless otherwise specified)

Symbol	Parameter	Test condition	Min.	Typ.	Max.	Unit
$V_{LR}$	Load regulation	6500 grpm, 10% to 95% load			300	mV
$V_{SR}$	Speed regulation	15A load, 2000 to 20,000 grpm			100	mV
$V_{F-ON}$	Output saturation voltage	$I_F = 6A, V_{GO} = 14.0V, T_{case} = 25^{\circ}C$			750	mV
$V_{F-ON}$	Output saturation voltage	$I_F = 5A, V_{GO} = 13.5V, T_{case} = 125^{\circ}C$			850	mV
$I_{F-LIM}$	Field limit current <sup>(1)</sup>	Current F+ Terminal to Gnd. @ $T_{case} \leq 25^{\circ}C$	9.0			A
$I_{F-LIM}$	Field limit current <sup>(1)</sup>	Current F+ Terminal to Gnd. @ $T_{case} = +150^{\circ}C$	6.0			A
$I_{G-MIN}$	Min. generator current load	Current measured @ generator output	0.5			A
$V_{D-F}$	Field discharge diode	$I_F = 6A, T_{case} = 25^{\circ}C$			1.85	V
$I_{D-R}$	Diode reverse current	$V_R = 20V$			1	mA
$F_{OSC}$	oscillation frequency	During LRC operation	340	400	460	Hz
$V_{DF}$	DF saturation voltage	$I_{DF} \leq 10mA$			0.8	V
$I_{DF-LK}$	DF output leakage current	$V_{DF} < 25V$			10	$\mu A$
$F_{TURBO}$	Internal clock frequency	$V_{DF} = 32 - 35V; \text{ thru } 2.2k\Omega$		4X		Hz
$F_{TURBO}$	IRD, SS, LRC rate	$V_{DF} = 32 - 35V; \text{ thru } 2.2k\Omega$		$\div 16$		

1. The Field Drive capability shall not decrease as a function of temperature between  $25^{\circ}C$  and  $150^{\circ}C$ , at a rate faster than  $-0.024A/^{\circ}C$  (for example, Field Drive shall be capable of  $\geq 7.2A$  at  $100^{\circ}C$ ).

**Figure 2. Typical application schematic**

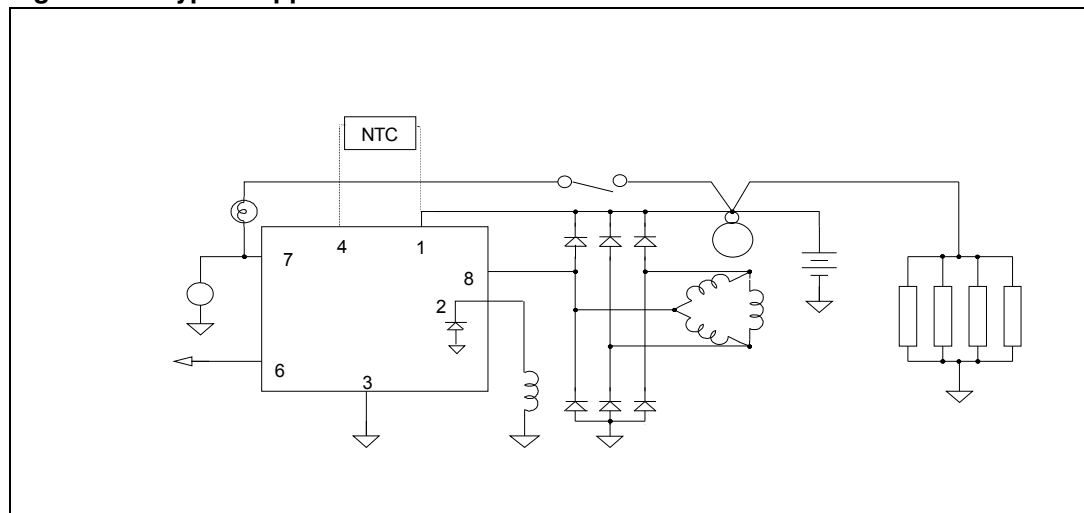

**Figure 3. Set-point voltage vs. mounting tab temperature (10kΩ between V<sub>GO</sub> & TS)**

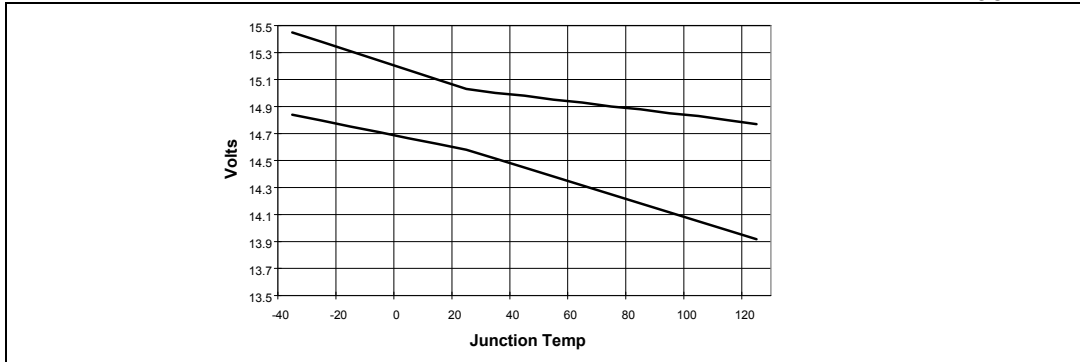

**Figure 4. Set-point voltage vs. thermistor temperature, T<sub>j</sub> = 90°C (not guaranteed by testing, depending on NTC characteristics)**

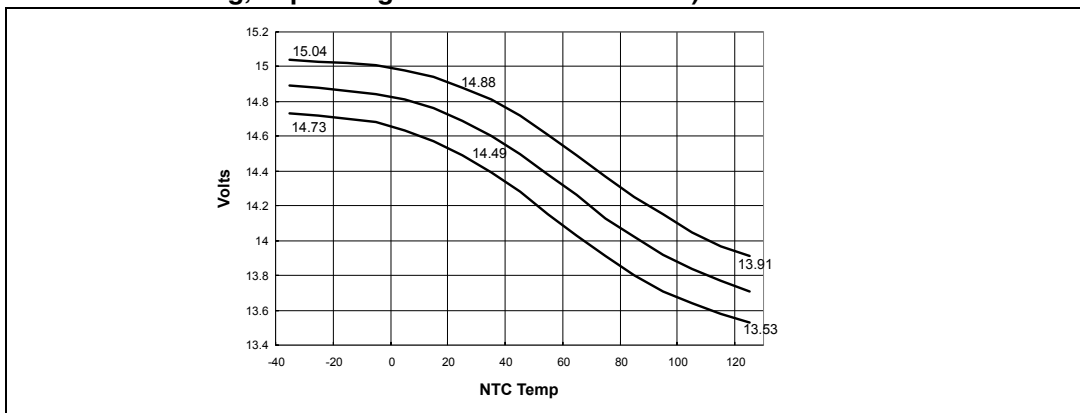

**Figure 5. Set-point voltages vs. mounting tab temperature (TS-open)**

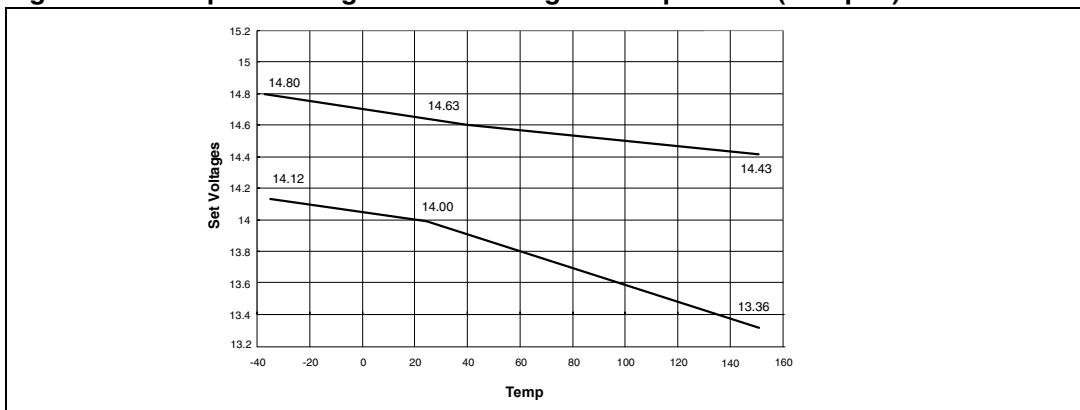

## 2.4 Diagnostic

**Table 6. Diagnostic**  
( $T_{case} = -35^{\circ}\text{C}$  to  $+150^{\circ}\text{C}$  unless otherwise specified)

Symbol	Parameter	Conditions	Min.	Typ.	Max.	Units
$V_{OV}$	Over-voltage		$V_{SP} + 1$	$V_{SP} + 1.3$	$V_{SP} + 2$	V
$V_{L-SAT}$	Lamp ON saturation voltage	$I_L = 0.5\text{A}$ (sunked by ASVR)	$>V_{L-ACT}$	1.33	1.45	V
$V_{L-SAT-BO}$	Lamp ON voltage <sup>(1)</sup>	$I_L < 0.5\text{A}$ , VGO = open; $T_{case} = -35^{\circ}\text{C}$ to $85^{\circ}\text{C}$		3.8	5	V
$V_{L-RLY}$	Lamp OFF (relay drive) saturation voltage (vs. B+)	$I_L = 750\text{mA}$ (sourced by ASVR) <sup>(2)</sup> $T_{case} < 125^{\circ}\text{C}$			1.85	V
$T_{DELAY}$	Fault indication delay time	Delay before lamp ON	0.9	1.1	1.3	s

1. This condition can happen when the connection between the battery and VGO or the output terminal of the generator is broken. The 1.1 second delay is not required, and current is sunked by ASVR.
2. When no fault is detected the Lamp terminal is pulled up by ASVR.

## 2.5 Fault indication

**Table 7. Fault indication table**

Conditions	$T_{Delay}$ ?
Initial KEY-ON Bulb and wiring check (lamp ON for 1 sec $\pm$ 15% after initial KEY-ON)	No
$V_{GO} > V_{OV}$	Yes
$V_P < V_{P-F}$ AND $V_{GO} < V_{SP}$	Yes
$F_P < F_{P-TR}$ @ $V_{P-TR}$	Yes
No connection between battery and $V_{GO}$	No
At start: lamp ON until $F_P > F_{P-IR}$ AND $V_P > V_{P-F}$ i.e. until $V_P$ reaches 8V.	No

## 2.6 Regulation features

**Table 8. Regulation features**

Symbol	Parameter	Conditions	Min.	Typ.	Max.	Unit
$V_{L-PD}$	L terminal regulator activate threshold	VGO=12.6V	0.8	1	1.15	V
$I_{L-PD}$	L terminal pull down current	$V_L = V_{L-ACT}$ VGO=12.6V	0.09		0.78	mA
$V_{P-IR}$	Initiate regulation phase voltage threshold	Regulator activated	1.1	1.3	1.5	V
$V_{P-TR}$	Terminate regulation phase voltage threshold	Regulator activated	1.1	1.3	1.5	V

**Table 8. Regulation features (continued)**

Symbol	Parameter	Conditions	Min.	Typ.	Max.	Unit
$V_{P-F}$	Phase input voltage low fault threshold		7.0	8	9.0	V
$I_P$	Phase terminal current sink	$V_P > 1.5V$ and $< 12.6V$ $V_{GO} = 12.6V$	0.3		3.5	mA
$F_{P-IR}$	Initiate regulation phase frequency		123	145	167	Hz
$F_{P-TR}$	Terminate regulation phase frequency		59	72	86	Hz
IRD	Initiate regulation delay	Regulator activated, $V_{P-IR}$ AND $F_{P-IR}$ conditions met first time.	1.7	2	2.3	s
FSDC	Field strobe duty cycle	Regulator activated and (regulation terminated or regulation not initiated)	16	18.75	22	%
LRC	Load response control rate	Field drive duty cycle increase	34	40	46	%/s
$F_{P-LRC}$	LRC transition frequency	LRC enabled if $F_P < F_{P-LRC}$	255	300	345	Hz
SS	Soft-start	LRC enabled until $V_{SP}$ reached regardless other conditions	34	40	46	%/s



### 3 Package information

In order to meet environmental requirements, ST (also) offers these devices in ECOPACK® packages. ECOPACK® packages are lead-free. The category of second Level Interconnect is marked on the package and on the inner box label, in compliance with JEDEC Standard JESD97. The maximum ratings related to soldering conditions are also marked on the inner box label.

ECOPACK is an ST trademark. ECOPACK specifications are available at: [www.st.com](http://www.st.com).

**Figure 6. Multiwatt8 mechanical data and package dimensions**

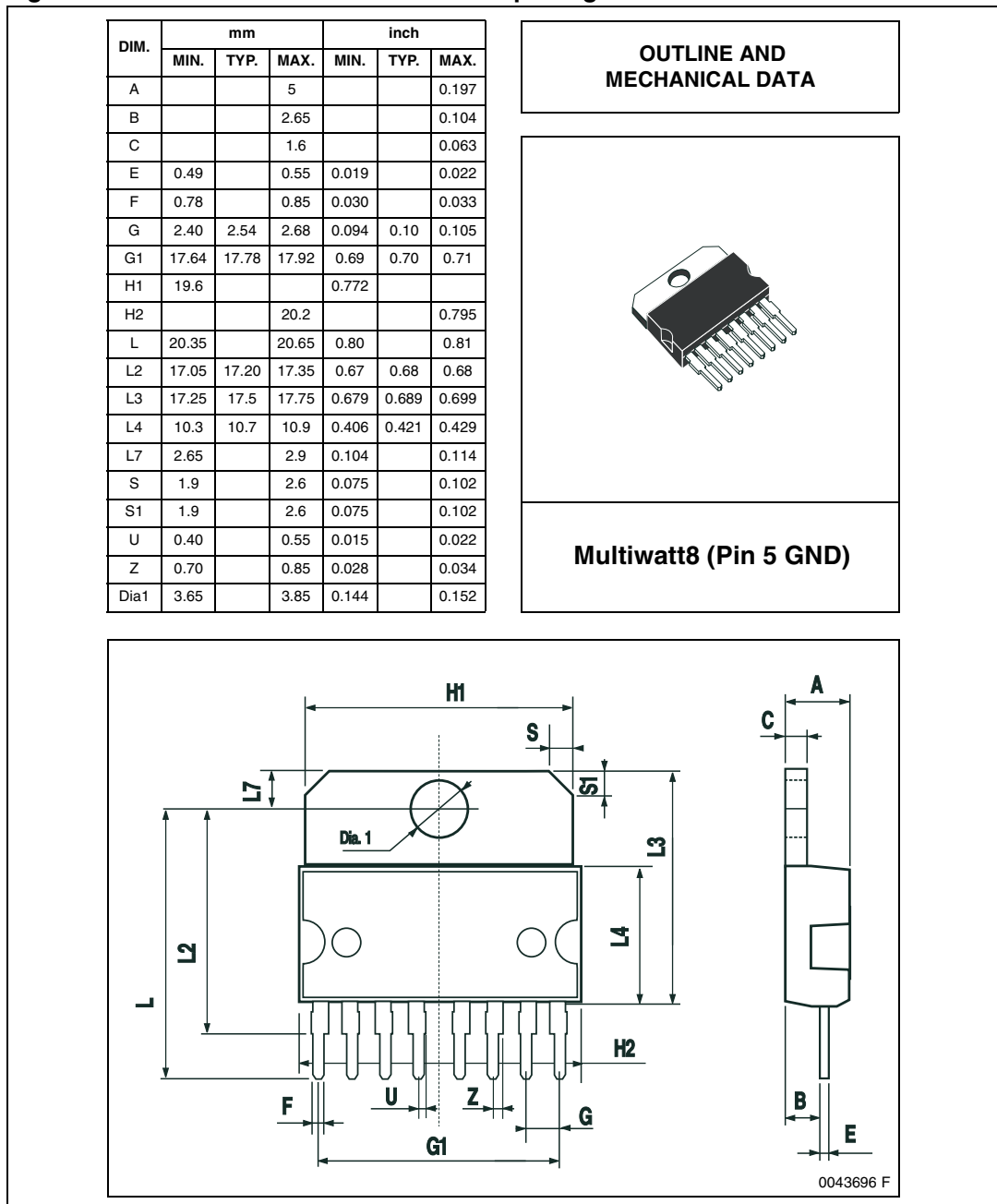

## 4 Revision history

**Table 9. Document revision history**

Date	Revision	Changes
15-Feb-2003	1	Initial release.
09-Sept-2004	2	Update
18-Nov-2008	3	Document reformatted. Document promoted from “product preview” to “datasheet”. Added <a href="#">Table 1: Device summary on page 1</a> . Added ECOPACK text in <a href="#">Section 3: Package information</a> .
19-Sep-2013	4	Updated Disclaimer.

**Please Read Carefully:**

Information in this document is provided solely in connection with ST products. STMicroelectronics NV and its subsidiaries ("ST") reserve the right to make changes, corrections, modifications or improvements, to this document, and the products and services described herein at any time, without notice.

All ST products are sold pursuant to ST's terms and conditions of sale.

Purchasers are solely responsible for the choice, selection and use of the ST products and services described herein, and ST assumes no liability whatsoever relating to the choice, selection or use of the ST products and services described herein.

No license, express or implied, by estoppel or otherwise, to any intellectual property rights is granted under this document. If any part of this document refers to any third party products or services it shall not be deemed a license grant by ST for the use of such third party products or services, or any intellectual property contained therein or considered as a warranty covering the use in any manner whatsoever of such third party products or services or any intellectual property contained therein.

**UNLESS OTHERWISE SET FORTH IN ST'S TERMS AND CONDITIONS OF SALE ST DISCLAIMS ANY EXPRESS OR IMPLIED WARRANTY WITH RESPECT TO THE USE AND/OR SALE OF ST PRODUCTS INCLUDING WITHOUT LIMITATION IMPLIED WARRANTIES OF MERCHANTABILITY, FITNESS FOR A PARTICULAR PURPOSE (AND THEIR EQUIVALENTS UNDER THE LAWS OF ANY JURISDICTION), OR INFRINGEMENT OF ANY PATENT, COPYRIGHT OR OTHER INTELLECTUAL PROPERTY RIGHT.**

**ST PRODUCTS ARE NOT DESIGNED OR AUTHORIZED FOR USE IN: (A) SAFETY CRITICAL APPLICATIONS SUCH AS LIFE SUPPORTING, ACTIVE IMPLANTED DEVICES OR SYSTEMS WITH PRODUCT FUNCTIONAL SAFETY REQUIREMENTS; (B) AERONAUTIC APPLICATIONS; (C) AUTOMOTIVE APPLICATIONS OR ENVIRONMENTS, AND/OR (D) AEROSPACE APPLICATIONS OR ENVIRONMENTS. WHERE ST PRODUCTS ARE NOT DESIGNED FOR SUCH USE, THE PURCHASER SHALL USE PRODUCTS AT PURCHASER'S SOLE RISK, EVEN IF ST HAS BEEN INFORMED IN WRITING OF SUCH USAGE, UNLESS A PRODUCT IS EXPRESSLY DESIGNATED BY ST AS BEING INTENDED FOR "AUTOMOTIVE, AUTOMOTIVE SAFETY OR MEDICAL" INDUSTRY DOMAINS ACCORDING TO ST PRODUCT DESIGN SPECIFICATIONS. PRODUCTS FORMALLY ESCC, QML OR JAN QUALIFIED ARE DEEMED SUITABLE FOR USE IN AEROSPACE BY THE CORRESPONDING GOVERNMENTAL AGENCY.**

Resale of ST products with provisions different from the statements and/or technical features set forth in this document shall immediately void any warranty granted by ST for the ST product or service described herein and shall not create or extend in any manner whatsoever, any liability of ST.

ST and the ST logo are trademarks or registered trademarks of ST in various countries.

Information in this document supersedes and replaces all information previously supplied.

The ST logo is a registered trademark of STMicroelectronics. All other names are the property of their respective owners.

© 2013 STMicroelectronics - All rights reserved

STMicroelectronics group of companies

Australia - Belgium - Brazil - Canada - China - Czech Republic - Finland - France - Germany - Hong Kong - India - Israel - Italy - Japan - Malaysia - Malta - Morocco - Philippines - Singapore - Spain - Sweden - Switzerland - United Kingdom - United States of America

[www.st.com](http://www.st.com)

# Mouser Electronics

Authorized Distributor

Click to View Pricing, Inventory, Delivery & Lifecycle Information:

[STMicroelectronics:](#)

[L9484](#)