

## 300 mA very low quiescent current linear regulator IC with the automatic green mode

Datasheet - production data

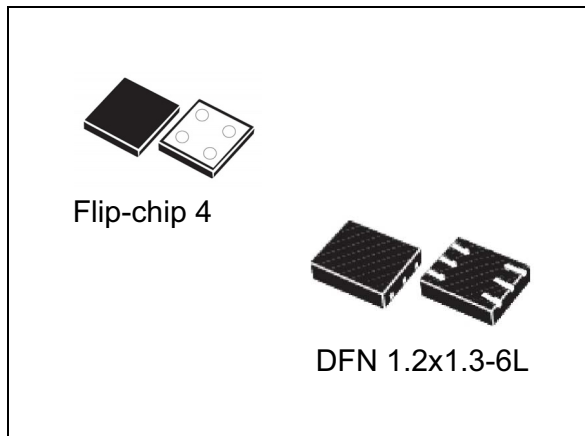

### Features

- Input voltage from 1.4 to 5.5 V
- Ultra low dropout voltage (300 mV typ. at 300 mA load)
- Automatic green mode
- Very low quiescent current (1  $\mu$ A in green mode, 45  $\mu$ A in normal mode and 0.1  $\mu$ A typ. in off mode)
- Output voltage tolerance:  $\pm 1.0\%$  at 25  $^{\circ}$ C
- 300 mA guaranteed output current
- Wide range of output voltages available on request: adjustable from 0.8 V, fixed up to 4.0 V in 100 mV step
- Logic-controlled electronic shutdown
- Internal soft-start
- Compatible with ceramic capacitor  
 $C_{OUT} = 330$  nF
- Internal current foldback and thermal protections
- Available in DFN6 1.2x1.3 mm and Flip-chip 4 bumps 0.69 x 0.69 mm. 0.4 pitch
- Operating temperature range: -40  $^{\circ}$ C to 125  $^{\circ}$ C

### Applications

- Mobile phones
- Personal digital assistants (PDAs)
- Digital still cameras (DSC)
- Cordless phones and similar battery-powered systems
- Portable media players

### Description

The LD39130S is a high accuracy voltage regulator that provides 300 mA maximum current from an input voltage ranging from 1.4 V to 5.5 V, with a typical dropout voltage of 300 mV.

It is available in DFN6 1.2x1.3 mm package and in ultra small CSP 4 bumps package, allowing the maximum space saving.

The device is stabilized with a ceramic capacitor on the output. The ultra low drop voltage, low quiescent current and low noise features make it suitable for low power battery-operated applications. It integrates an internal logic circuitry, which allows the regulator to be in ultra low consumption mode (green mode), when the output current required is very low. The normal working mode, with fast transient response, is restored when the load current increases.

The enable logic control function puts the LD39130S in shutdown mode allowing a total current consumption lower than 0.1  $\mu$ A. The current foldback and thermal protection are provided.

# Contents

<b>1</b>	<b>Diagram</b> .....	<b>3</b>
<b>2</b>	<b>Pin configuration</b> .....	<b>4</b>
<b>3</b>	<b>Typical characteristics</b> .....	<b>5</b>
<b>4</b>	<b>Maximum ratings</b> .....	<b>6</b>
<b>5</b>	<b>Application information</b> .....	<b>11</b>
5.1	Soft-start function .....	11
5.2	Auto green mode function .....	11
5.3	Input and output capacitors .....	11
5.3.1	Input capacitor .....	11
5.3.2	Output capacitor .....	11
<b>6</b>	<b>Typical characteristics</b> .....	<b>12</b>
<b>7</b>	<b>Package mechanical data</b> .....	<b>20</b>
7.1	Flip-chip 4 .....	21
7.2	DFN6 1.2x1.3 mm .....	23
<b>8</b>	<b>Order codes</b> .....	<b>25</b>
<b>9</b>	<b>Revision history</b> .....	<b>26</b>

# 1 Diagram

Figure 1. Block diagram (adjustable version)

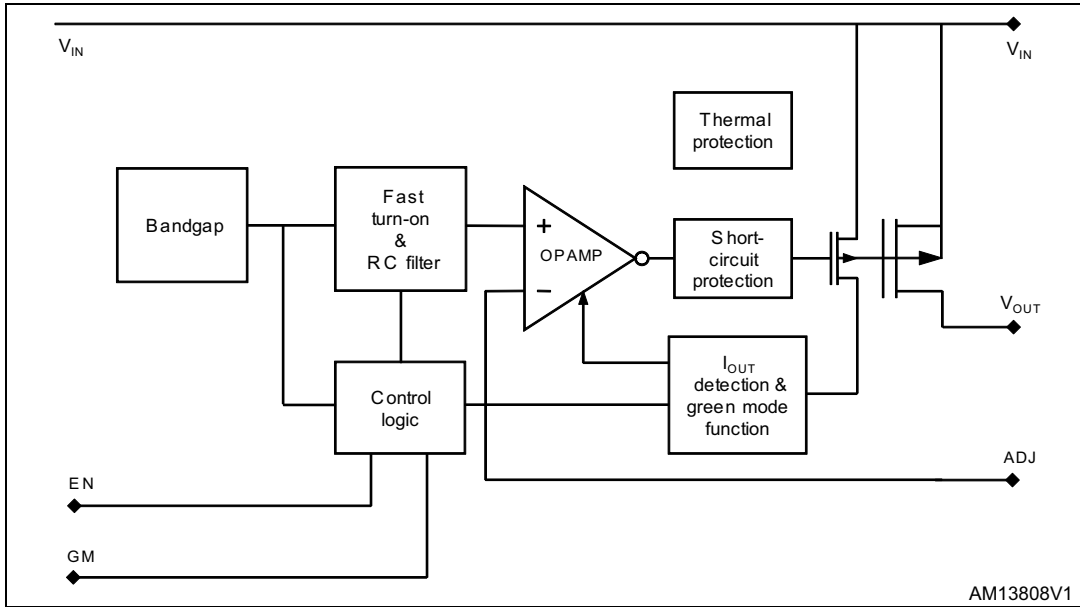
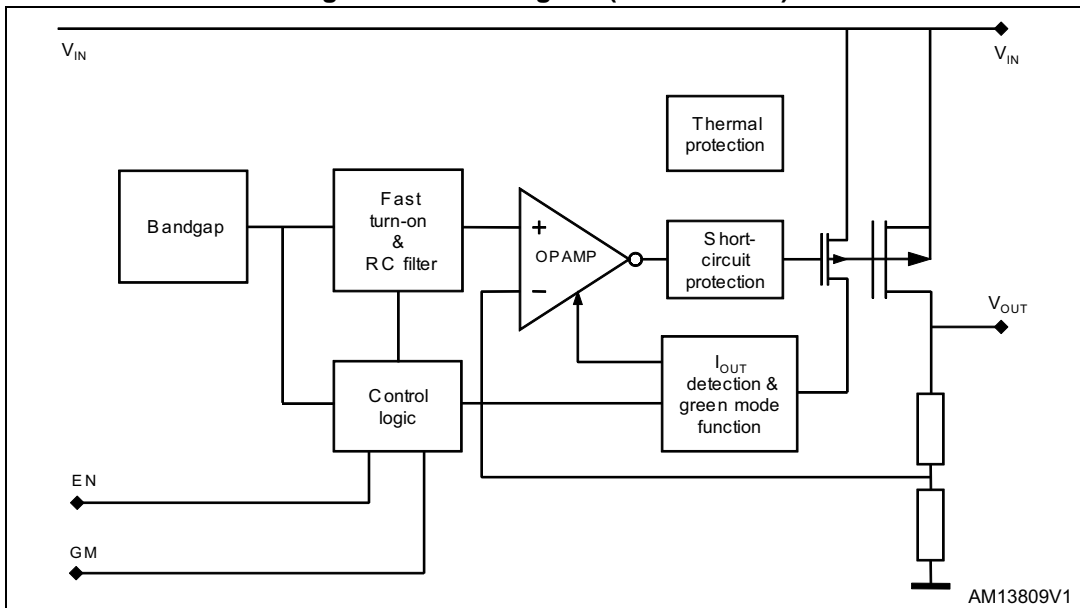

Figure 2. Block diagram (fixed version)



## 2 Pin configuration

Figure 3. Pin connection (top view)

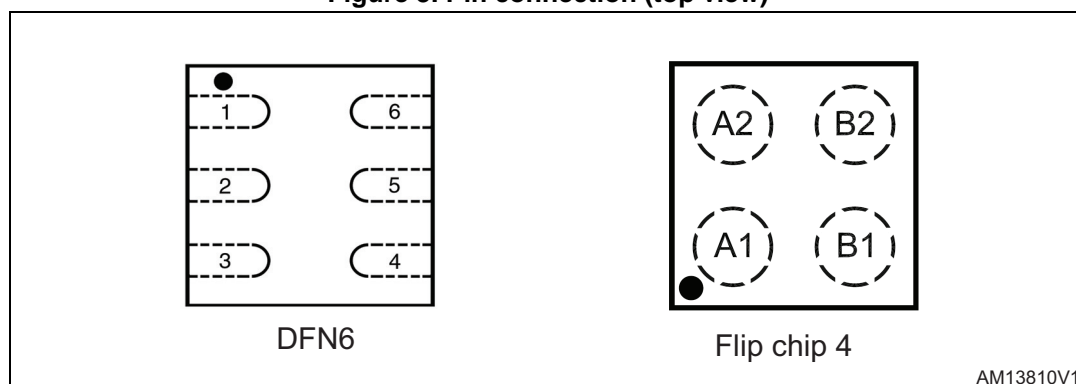

Table 1. Pin description

Pin n°		Symbol	Function
DFN6	Flip chip		
1		GM	Auto green mode selection: low = active, high = disabled
2	B2	GND	Common ground
3	B1	EN	Enable pin logic input: low = shutdown, high = active
4	A1	IN	Input voltage
5		ADJ/NC <sup>(1)</sup>	Adjust pin
6	A2	OUT	Output voltage

1. Not connected in the fixed output voltage version.

### 3 Typical characteristics

Figure 4. Typical application circuits

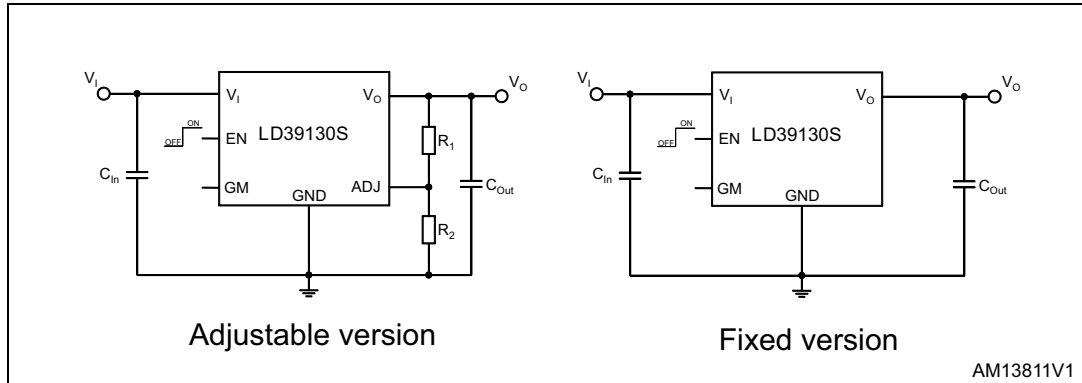

Note: GM and ADJ pins are available on the DFN6 package only.

## 4 Maximum ratings

**Table 2. Absolute maximum ratings**

Symbol	Parameter	Value	Unit
$V_{IN}$	DC input voltage	- 0.3 to 7	V
$V_{OUT}$	DC output voltage	- 0.3 to $V_I + 0.3$	V
$V_{EN}$	Enable input voltage	- 0.3 to $V_I + 0.3$	V
$V_{GM}$	Auto green mode input voltage	- 0.3 to $V_I + 0.3$	V
$V_{ADJ}$	Adjust pin voltage	- 0.3 to 2	V
$I_{OUT}$	Output current	Internally limited	mA
$P_D$	Power dissipation	Internally limited	mW
$T_{STG}$	Storage temperature range	- 65 to 150	°C
$T_{OP}$	Operating junction temperature range	- 40 to 125	°C

*Note:* Absolute maximum ratings are those values beyond which damage to the device may occur. Functional operation under these conditions is not implied. All values are referred to GND.

**Table 3. Thermal data**

Symbol	Parameter	Value		Unit
		DFN6	Flip chip 4	
$R_{thJA}$	Thermal resistance junction-ambient	237	130	°C/W
$R_{thJC}$	Thermal resistance junction-case	104		°C/W

**Table 4. ESD performance**

Symbol	Parameter	Test conditions	Value	Unit
ESD	ESD protection voltage	HBM	2	kV
		CDM(DFN version)	200	V
		CDM(CSP version)	300	V

$T_J = 25\text{ °C}$ ,  $V_{IN} = V_{OUT(NOM)} + 1\text{ V}$ ,  $C_{IN} = C_{OUT} = 1\text{ }\mu\text{F}$ ,  $I_{OUT} = 1\text{ mA}$ ,  $V_{EN} = V_{IN}$ , unless otherwise specified.

**Table 5. LD39130S/LD39130SJ electrical characteristics (fixed versions)**

Symbol	Parameter	Test conditions	Min.	Typ.	Max.	Unit
$V_{IN}$	Operating input voltage		1.4		5.5	V
$V_{OUT}$	$V_{OUT}$ accuracy (normal mode)	$V_{OUT} > 2\text{ V}$ , $I_{OUT} = 10\text{ mA}$ , $T_J = 25\text{ °C}$	-1.0		1.0	%
		$V_{OUT} > 2\text{ V}$ , $I_{OUT} = 10\text{ mA}$ , $-40\text{ °C} < T_J < 125\text{ °C}$	-2		2	%
		$V_{OUT} \leq 2\text{ V}$ , $I_{OUT} = 10\text{ mA}$ , $T_J = 25\text{ °C}$	-20		20	mV
		$V_{OUT} \leq 2\text{ V}$ , $I_{OUT} = 10\text{ mA}$ , $-40\text{ °C} < T_J < 125\text{ °C}$	-30		30	mV
	$V_{OUT}$ accuracy (green mode)	$V_{OUT} > 2\text{ V}$ , $I_{OUT} = 1\text{ mA}$ , $T_J = 25\text{ °C}$	-1.0		1.0	%
		$V_{OUT} > 2\text{ V}$ , $I_{OUT} = 1\text{ mA}$ , $-40\text{ °C} < T_J < 125\text{ °C}$	-2		2	%
		$V_{OUT} \leq 2\text{ V}$ , $I_{OUT} = 1\text{ mA}$ , $T_J = 25\text{ °C}$	-20		20	mV
		$V_{OUT} \leq 2\text{ V}$ , $I_{OUT} = 1\text{ mA}$ , $-40\text{ °C} < T_J < 125\text{ °C}$	-30		30	mV
$\Delta V_{OUT}$	Static line regulation (normal mode)	$V_{OUT} + 0.5\text{ V} \leq V_{IN} \leq 5.5\text{ V}$ , $I_{OUT} = 10\text{ mA}$ $V_{IN} > 1.4\text{ V}$		0.02	0.20	%/V
	Static line regulation (green mode)	$V_{OUT} + 0.5\text{ V} \leq V_{IN} \leq 5.5\text{ V}$ , $I_{OUT} = 1\text{ mA}$ $V_{IN} > 1.4\text{ V}$			0.50	%/V
$\Delta V_{OUT}$	Static load regulation	$V_{OUT} > 2\text{ V}$ , $I_{OUT} = 1\text{ mA}$ to $12\text{ mA}$	-1.5		1.5	%
		$12\text{ mA}$ to $300\text{ mA}$ (normal mode)		0.004		%/mA
$V_{DROP}$	Dropout voltage <sup>(1)</sup>	$I_{OUT} = 300\text{ mA}$ , $V_{OUT} > 2\text{ V}$ $-40\text{ °C} < T_J < 125\text{ °C}$		300		mV
$e_N$	Output noise voltage	10 Hz to 100 kHz, $I_{OUT} = 1\text{ mA}$		100		$\mu\text{V}_{RMS}$
		10 Hz to 100 kHz, $I_{OUT} = 15\text{ mA}$		38		
SVR	Supply voltage rejection $V_{OUT} = 1.5\text{ V}$ (normal mode)	$V_{IN} = V_{OUTNOM} + 1\text{ V} + / - V_{RIPPLE}$ $V_{RIPPLE} = 0.1\text{ V}$ , freq. = 1 kHz $I_{OUT} = 30\text{ mA}$		70		dB
		$V_{IN} = V_{OUTNOM} + 0.5\text{ V} + / - V_{RIPPLE}$ $V_{RIPPLE} = 0.1\text{ V}$ , freq. = 10 kHz $I_{OUT} = 30\text{ mA}$		65		
$I_Q$	Quiescent current (normal mode)	$I_{OUT} = 10\text{ mA}$		45		$\mu\text{A}$
	Quiescent current (Green mode)	$I_{OUT} = 0\text{ mA}$		1	4	$\mu\text{A}$
$I_{Standby}$	Standby current	$V_{IN}$ input current in off mode: $V_{EN} = \text{GND}$		0.1	1	$\mu\text{A}$
$I_{SC}$	Short-circuit current	$R_L = 0$ (current foldback protection)		50		mA

Table 5. LD39130S/LD39130SJ electrical characteristics (fixed versions) (continued)

Symbol	Parameter	Test conditions	Min.	Typ.	Max.	Unit
$I_{OUT}$	Output current		300			mA
$V_{EN}$	Enable input logic low	$V_{IN} = 1.4 \text{ V to } 5.5 \text{ V, } -40 \text{ }^\circ\text{C} < T_J < 125 \text{ }^\circ\text{C}$			0.4	V
	Enable input logic high	$V_{IN} = 1.4 \text{ V to } 5.5 \text{ V, } -40 \text{ }^\circ\text{C} < T_J < 125 \text{ }^\circ\text{C}$	1			
$I_{EN}$	Enable pin input current	$V_{SHDN} = V_{IN}$			100	nA
$I_{GH}$	Normal mode switch threshold	Change from light load to normal load $V_{GM} = \text{GND}^{(2)}$			10	mA
$I_{GL}$	Green mode switch threshold	Change from normal load to light load $V_{GM} = \text{GND}^{(2)}$	1	2		
$V_{GM}^{(2)}$	Green mode input logic low	$V_{IN} = 1.4 \text{ V to } 5.5 \text{ V, } -40 \text{ }^\circ\text{C} < T_J < 125 \text{ }^\circ\text{C}$			0.4	V
	Green mode input logic high	$V_{IN} = 1.4 \text{ V to } 5.5 \text{ V, } -40 \text{ }^\circ\text{C} < T_J < 125 \text{ }^\circ\text{C}$	1			
$I_{GM}^{(2)}$	Green mode pin current				100	nA
$T_{ON}^{(3)}$	Turn-on time			100		$\mu\text{s}$
$T_{SHDN}$	Thermal shutdown			160		$^\circ\text{C}$
	Hysteresis			20		
$C_{OUT}$	Output capacitor	Capacitance (see <a href="#">Section 6: Typical characteristics</a> )	0.33		22	$\mu\text{F}$

1. Dropout voltage is the input-to-output voltage difference at which the output voltage is 100 mV below its nominal value.
2. On DFN6 package version only.
3. Turn-on time is time measured between the enable input just exceeding  $V_{EN}$  high value and the output voltage just reaching 95% of its nominal value.



$T_J = 25\text{ °C}$ ,  $V_{IN} = V_{OUT(NOM)} + 1\text{ V}$ ,  $C_{IN} = C_{OUT} = 1\text{ }\mu\text{F}$ ,  $I_{OUT} = 1\text{ mA}$ ,  $V_{EN} = V_{IN}$ , unless otherwise specified.

**Table 6. LD39130S electrical characteristics (adjustable version)**

Symbol	Parameter	Test conditions	Min.	Typ.	Max.	Unit
$V_{IN}$	Operating input voltage		1.4		5.5	V
$V_{ADJ}$	$V_{ADJ}$ accuracy (fixed normal mode)	$I_{OUT} = 5\text{ mA}$ , $T_J = 25\text{ °C}$	780	800	820	mV
		$I_{OUT} = 5\text{ mA}$ , $V_{GM} = V_{IN}$ , $-40\text{ °C} < T_J < 125\text{ °C}$	770	800	830	mV
$\Delta V_{OUT}$	Static line regulation (normal mode)	$V_{OUT} + 0.5\text{ V} \leq V_{IN} \leq 5.5\text{ V}$ , $I_{OUT} = 10\text{ mA}$ $V_{IN} > 1.4\text{ V}$		0.02	0.20	%/V
	Static line regulation (green mode)	$V_{OUT} + 0.5\text{ V} \leq V_{IN} \leq 5.5\text{ V}$ , $I_{OUT} = 1\text{ mA}$ $V_{IN} > 1.4\text{ V}$			0.20	%/V
$\Delta V_{OUT}$	Static load regulation	$V_{OUT} > 2\text{ V}$ , $I_{OUT} = 1\text{ mA}$ to $12\text{ mA}$	-1.5		1.5	%
		$10\text{ mA}$ to $300\text{ mA}$ (normal mode)		0.004		%/mA
$V_{DROP}$	Dropout voltage <sup>(1)</sup>	$I_{OUT} = 300\text{ mA}$ , $V_{OUT} > 2\text{ V}$ $-40\text{ °C} < T_J < 125\text{ °C}$		300		mV
$e_N$	Output noise voltage	10 Hz to 100 kHz, $I_{OUT} = 1\text{ mA}$		97		$\mu\text{V}_{RMS}$
		10 Hz to 100 kHz, $I_{OUT} = 15\text{ mA}$		41		
SVR	Supply voltage rejection $V_{OUT} = 1.5\text{ V}$ (normal mode)	$V_{IN} = V_{OUTNOM} + 1\text{ V} + / - V_{RIPPLE}$ $V_{RIPPLE} = 0.1\text{ V}$ freq. = 1 kHz $I_{OUT} = 30\text{ mA}$		70		dB
		$V_{IN} = V_{OUTNOM} + 0.5\text{ V} + / - V_{RIPPLE}$ $V_{RIPPLE} = 0.1\text{ V}$ , Freq. = 10 kHz $I_{OUT} = 30\text{ mA}$		65		
$I_Q$	Quiescent current (normal mode)	$I_{OUT} = 10\text{ mA}$		45		$\mu\text{A}$
	Quiescent current (Green mode)	$I_{OUT} = 0\text{ mA}$		0.8	4	$\mu\text{A}$
$I_{Standby}$	Standby current	$V_{IN}$ input current in OFF MODE: $V_{EN} = \text{GND}$		0.1	1	$\mu\text{A}$
$I_{ADJ}$	Adjust pin current				1	$\mu\text{A}$
$I_{SC}$	Short-circuit current	$R_L = 0$ (current foldback protection)		50		mA
$I_{OUT}$	Output current		300			mA
$V_{EN}$	Enable input logic low	$V_{IN} = 1.4\text{ V}$ to $5.5\text{ V}$ , $-40\text{ °C} < T_J < 125\text{ °C}$			0.4	V
	Enable input logic high	$V_{IN} = 1.4\text{ V}$ to $5.5\text{ V}$ , $-40\text{ °C} < T_J < 125\text{ °C}$	1			
$I_{EN}$	Enable pin input current	$V_{SHDN} = V_{IN}$			100	nA
$I_{GH}$	Normal mode switch threshold	Change from light load to normal load $V_{GM} = \text{GND}$			10	mA
$I_{GL}$	Green mode switch threshold	Change from normal load to light load $V_{GM} = \text{GND}$	1	2		

Table 6. LD39130S electrical characteristics (adjustable version) (continued)

Symbol	Parameter	Test conditions	Min.	Typ.	Max.	Unit
V <sub>GM</sub>	Green mode input logic low	V <sub>IN</sub> = 1.4 V to 5.5 V, -40 °C < T <sub>J</sub> < 125 °C			0.4	V
	Green mode input logic high	V <sub>IN</sub> = 1.4 V to 5.5 V, -40 °C < T <sub>J</sub> < 125 °C	1			
I <sub>GM</sub>	Green mode pin current				100	nA
T <sub>ON</sub> ( <sup>2</sup> )	Turn on time			100		μs
T <sub>SHDN</sub>	Thermal shutdown			160		°C
	Hysteresis			20		
C <sub>OUT</sub>	Output capacitor	Capacitance (see <a href="#">Section 6: Typical characteristics</a> )	0.33		22	μF

- Dropout voltage is the input-to-output voltage difference at which the output voltage is 100 mV below its nominal value.
- Turn-on time is time measured between the enable input just exceeding V<sub>EN</sub> high value and the output voltage just reaching 95% of its nominal value

## 5 Application information

### 5.1 Soft-start function

The LD39130S has an internal soft-start circuit. By increasing the startup time up to 100  $\mu\text{s}$ , without the need of any external soft-start capacitor, this feature keeps the regulator inrush current at startup under control.

### 5.2 Auto green mode function

The LD39130S integrates an internal logic circuitry, which allows the regulator to be in ultra low consumption mode (green mode), when the output current required is very low.

When the auto green mode is enabled, the regulator automatically selects its operating mode, switching from a very low consumption operation at light loads, to a very fast transient response mode when the load current increases.

In the LD39130S, in DFN6 package, this function can be disabled by the user, by means of an external logic pin (GM). When the GM pin is set at high logic level, the device always operates in normal mode (fast transient response), while if the GM pin is set low, the auto green mode is enabled.

The LD39130SJ (CSP version) always operates in auto green mode.

### 5.3 Input and output capacitors

The LD39130S requires external capacitors to ensure the regulator control loop stability. These capacitors must be selected to meet the requirements of minimum capacitance and equivalent series resistance (see [Figure 32](#)). Locating the input/output capacitors as close as possible to the relative pins, is suggested.

#### 5.3.1 Input capacitor

A capacitor with a minimum value of 1  $\mu\text{F}$  is required at the input voltage of the LD39130S. This capacitor must be located as close as possible to the input pin of the device and returned to a clean analog ground. Any good quality ceramic capacitor can be used.

#### 5.3.2 Output capacitor

The control loop of the LD39130S is designed to work with ceramic capacitors at the output.

The output capacitor must meet the requirements for the minimum amount of capacitance and E.S.R. (equivalent series resistance) as shown in [Figure 32](#).

The suggested value of 1  $\mu\text{F}$  is a good choice to guarantee the stability of the regulator and to provide the optimum transient response. The output capacitor must maintain its ESR and capacitance in the stable region, over the full operating temperature range, to assure stability.

## 6 Typical characteristics

( $C_{IN} = C_{OUT} = 1 \mu\text{F}$ ,  $V_{EN} = V_{IN} = 1.8 \text{ V}$ ,  $V_{OUT} = V_{ADJ}$ ,  $T_j = 25 \text{ }^\circ\text{C}$  unless otherwise specified)

**Figure 5. Output voltage vs. temperature**  
( $V_{IN} = 1.8 \text{ V}$ ,  $I_{OUT} = 5 \text{ mA}$ , normal mode)

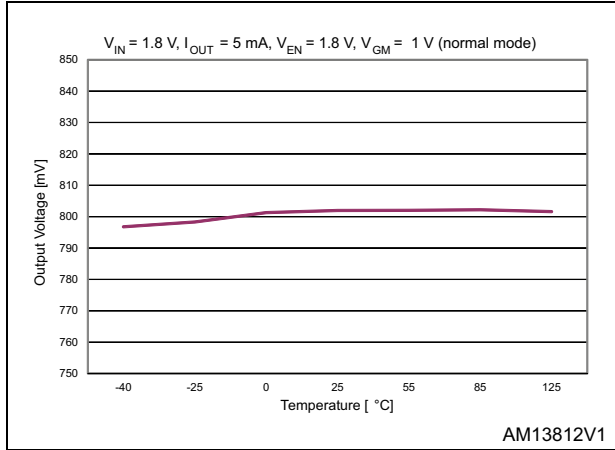

**Figure 6. Output voltage vs. temperature**  
( $V_{IN} = 1.8 \text{ V}$ ,  $I_{OUT} = 300 \text{ mA}$ , normal mode)

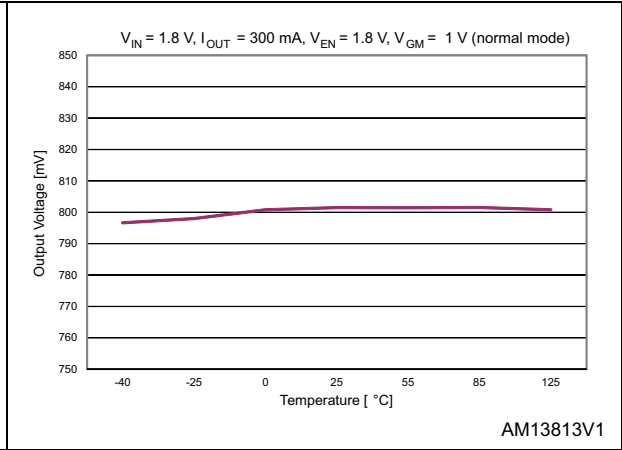

**Figure 7. Output voltage vs. temperature**  
( $V_{IN} = 1.4 \text{ V}$ ,  $I_{OUT} = 1 \text{ mA}$ , auto green mode)

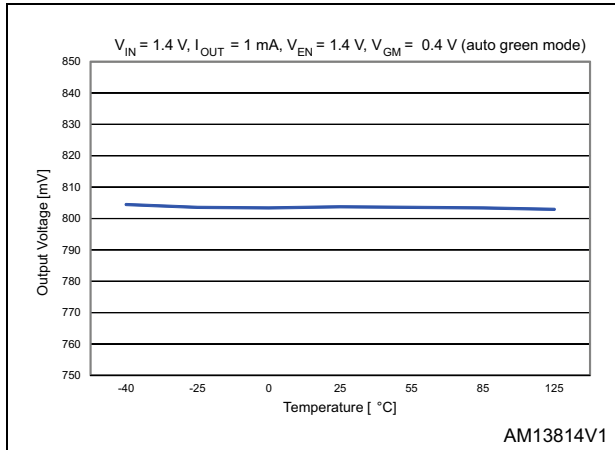

**Figure 8. Output voltage vs. temperature**  
( $V_{IN} = 5.5 \text{ V}$ ,  $I_{OUT} = 1 \text{ mA}$ , auto green mode)

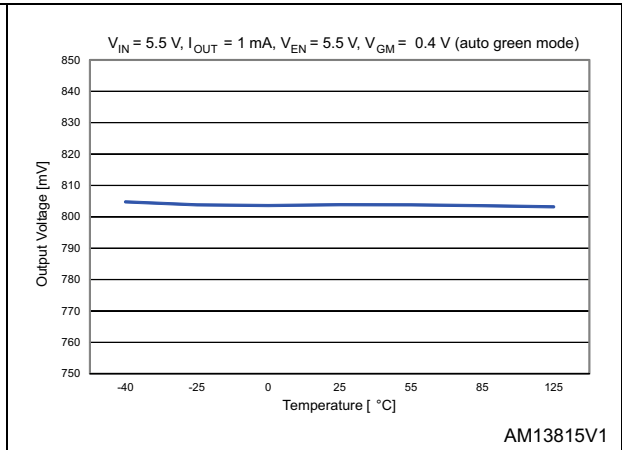

**Figure 9. Line regulation vs. temperature (normal mode)**

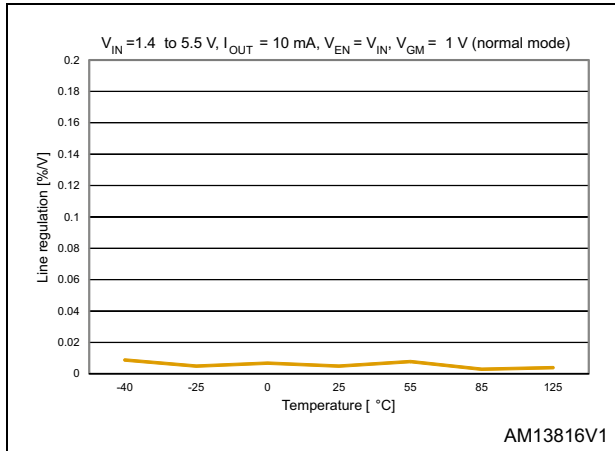

**Figure 10. Line regulation vs. temperature (auto green mode)**

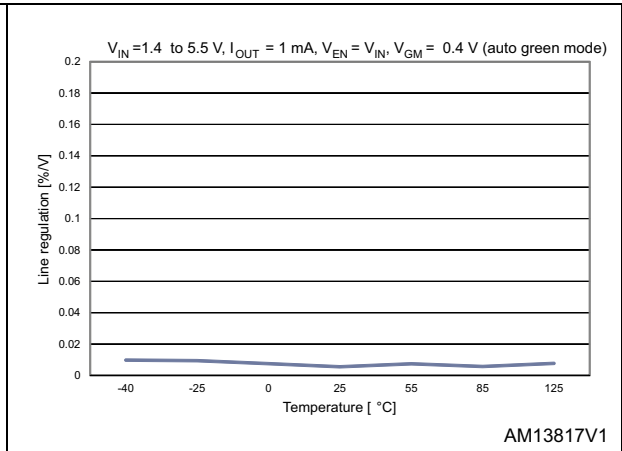

**Figure 11. Load regulation vs. temperature ( $I_{OUT} = 1$  to 10 mA, normal mode)**

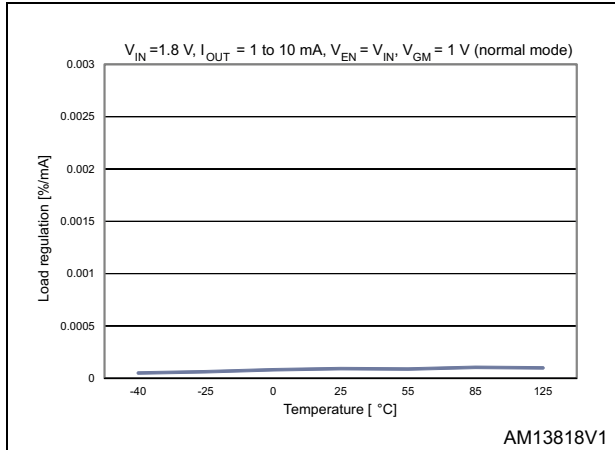

**Figure 12. Load regulation vs. temperature ( $I_{OUT} = 10$  to 300 mA, normal mode)**

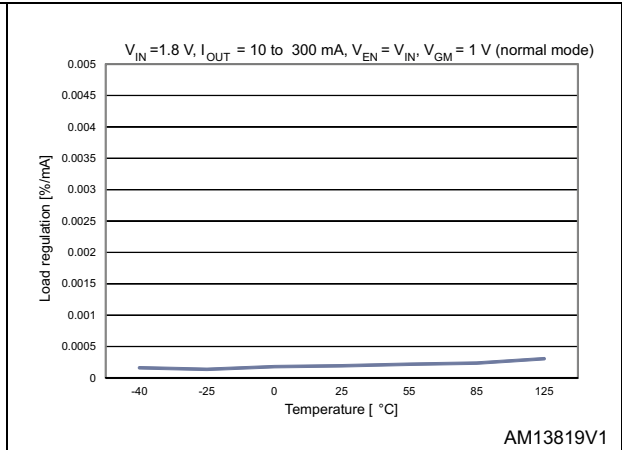

**Figure 13. Load regulation vs. temperature ( $I_{OUT} = 1$  to 12 mA, auto green mode)**

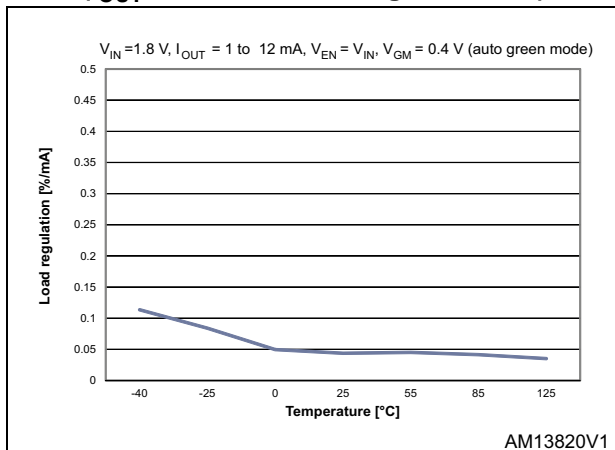

**Figure 14. Mode change thresholds vs. temperature**

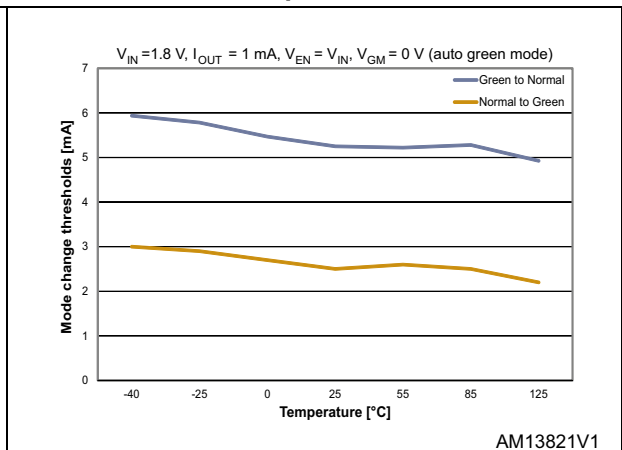

Figure 15. Quiescent current vs. temperature ( $I_{OUT} = 10 \text{ mA}$ , normal mode)

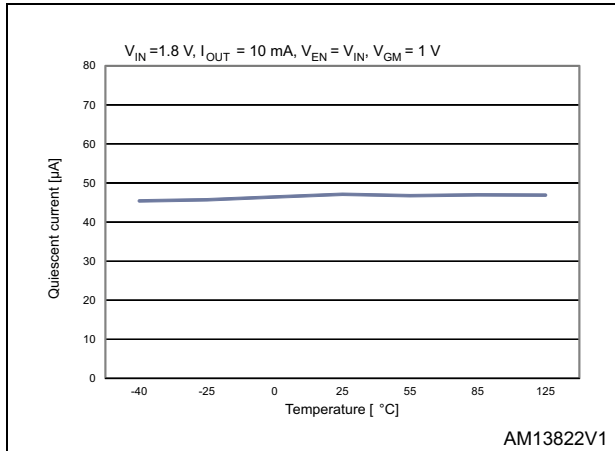

Figure 16. Quiescent current vs. temperature ( $I_{OUT} = 300 \text{ mA}$ , normal mode)

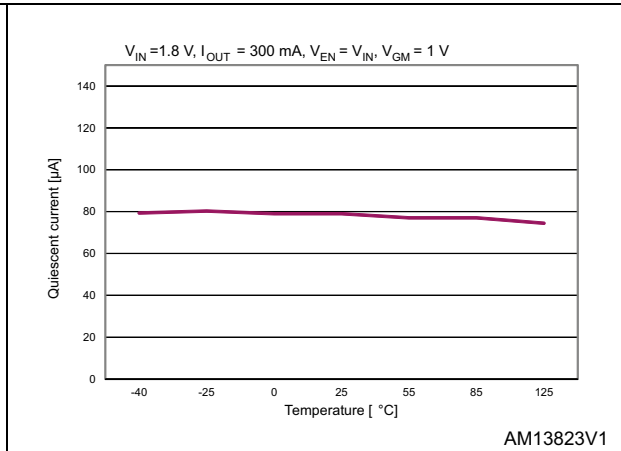

Figure 17. Quiescent current vs. temperature (no load, auto green mode)

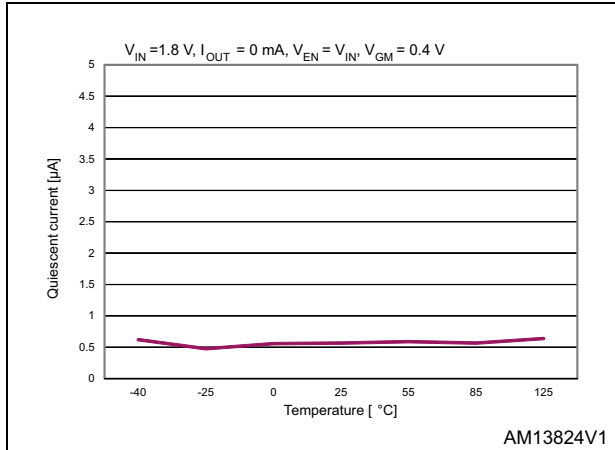

Figure 18. Shutdown current vs. temperature

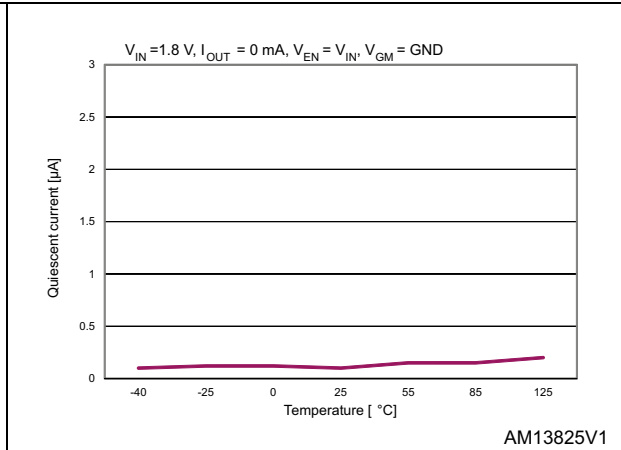

Figure 19. Quiescent current vs. input voltage (auto green mode)

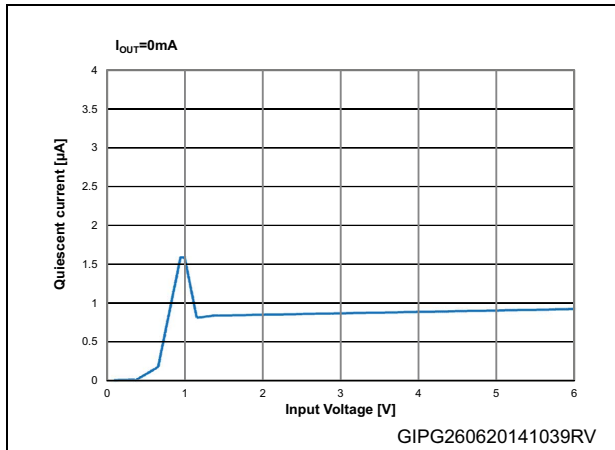

Figure 20. Quiescent current vs. input voltage (normal mode)

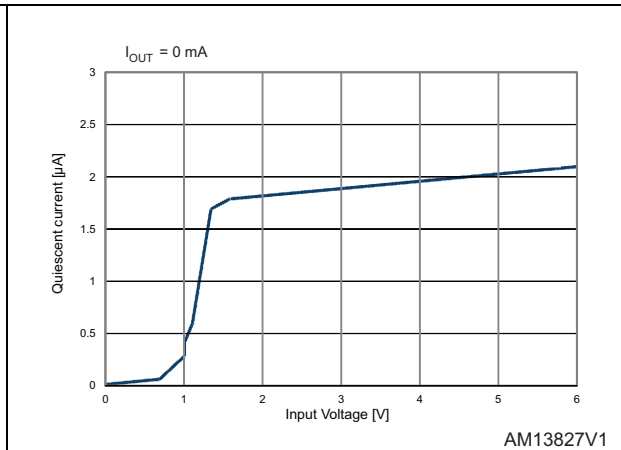

Figure 21. Quiescent current vs. output current (auto green mode)

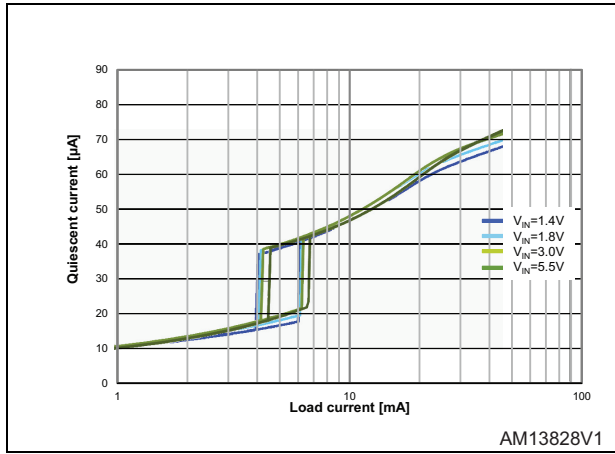

Figure 22. Quiescent current vs. load current (normal mode)

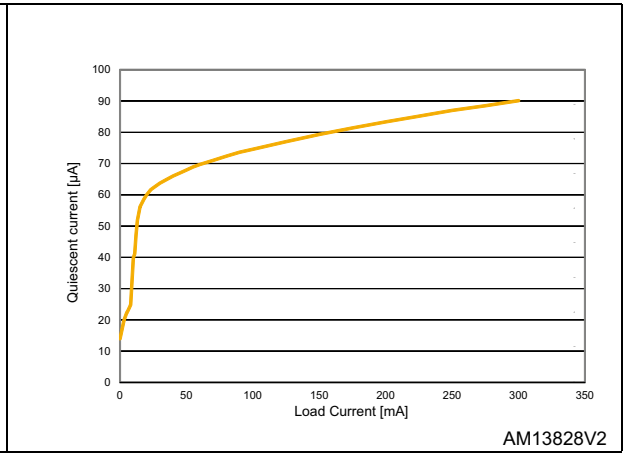

Figure 23. Quiescent current vs. load current (light load)

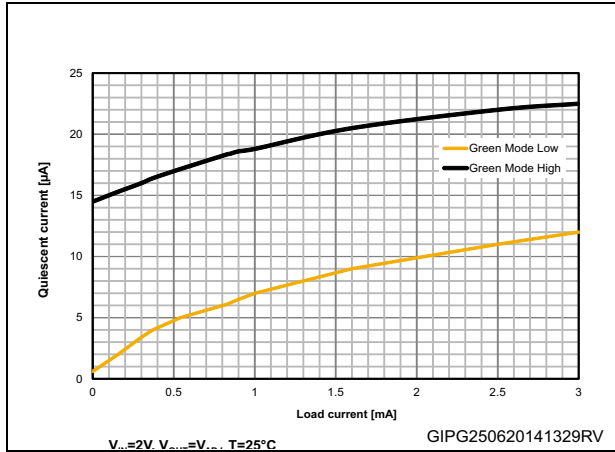

Figure 24. Short-circuit current vs. output voltage

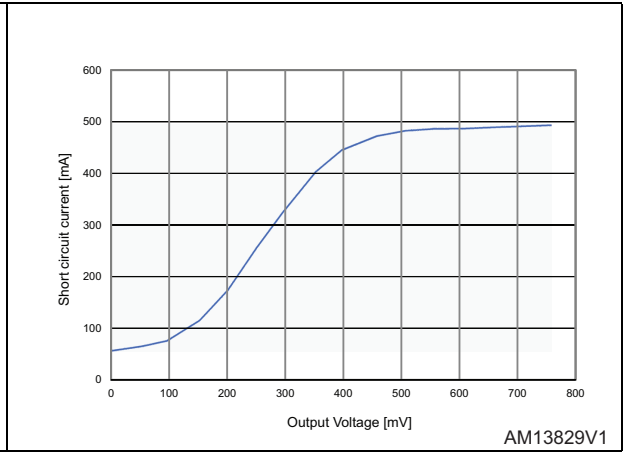

Figure 25. Foldback current vs. temperature

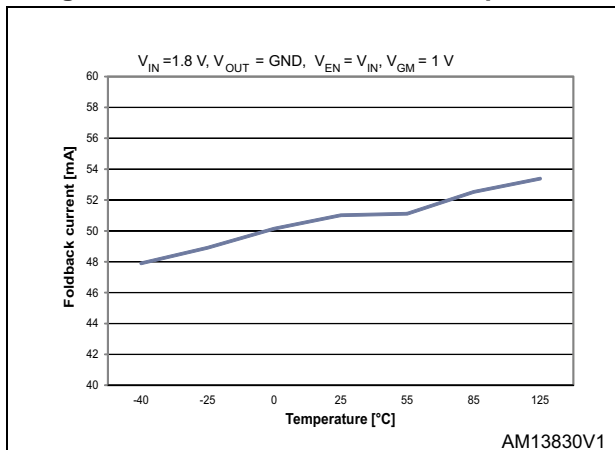

Figure 26. Dropout voltage vs. temperature

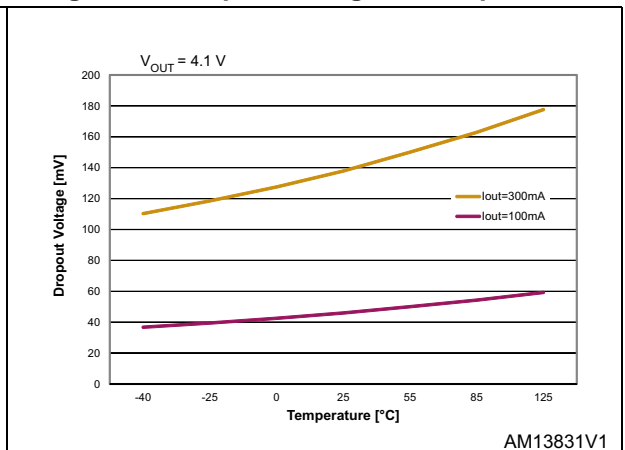

Figure 27. Dropout voltage vs. output current

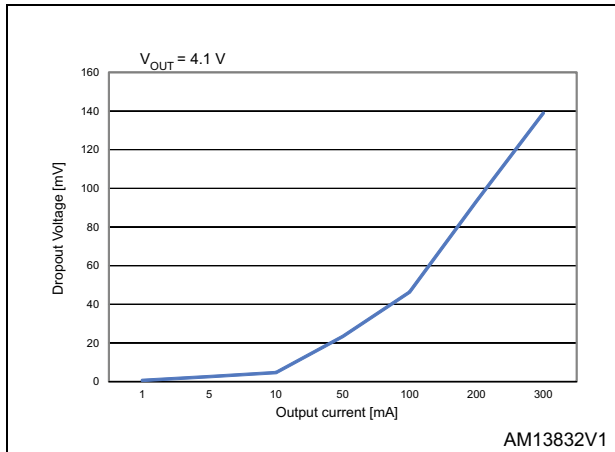

Figure 28. S.V.R. vs. frequency (normal mode)

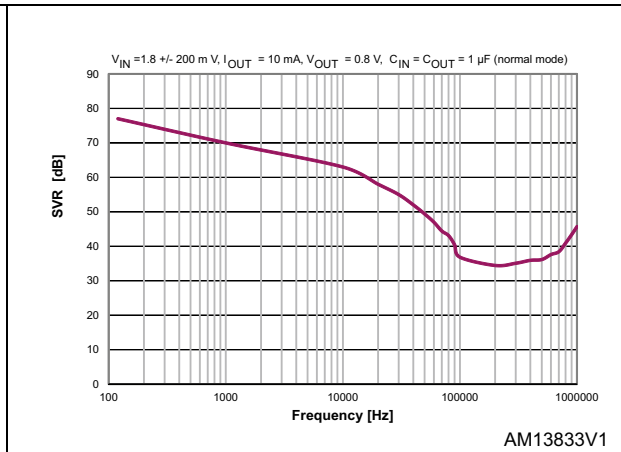

Figure 29. S.V.R. vs. frequency (green mode)

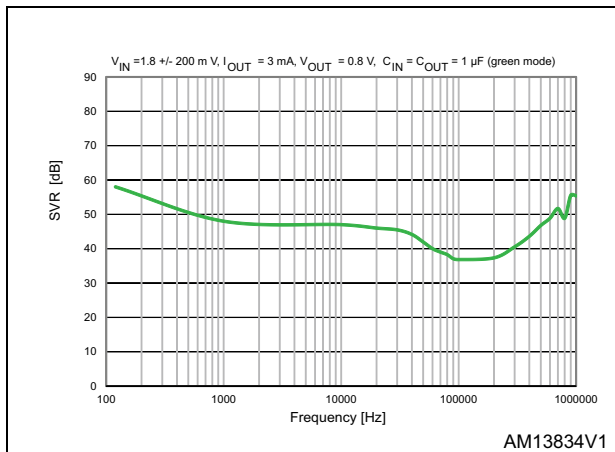

Figure 30. Noise spectrum vs. frequency ( $V_{OUT} = V_{ADJ}$ )

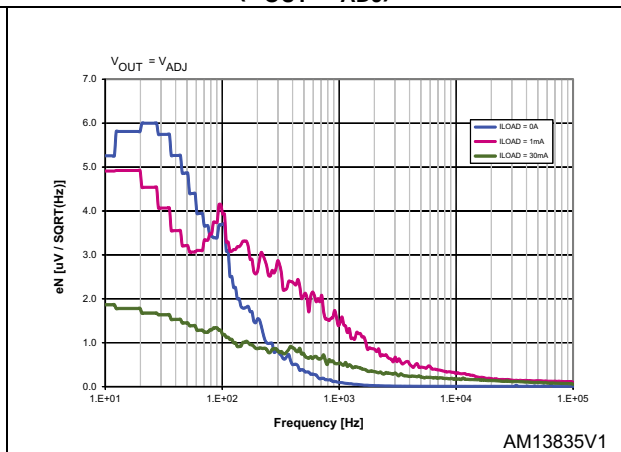

Figure 31. Noise spectrum vs. frequency ( $V_{OUT} = 4.1\text{ V}$ )

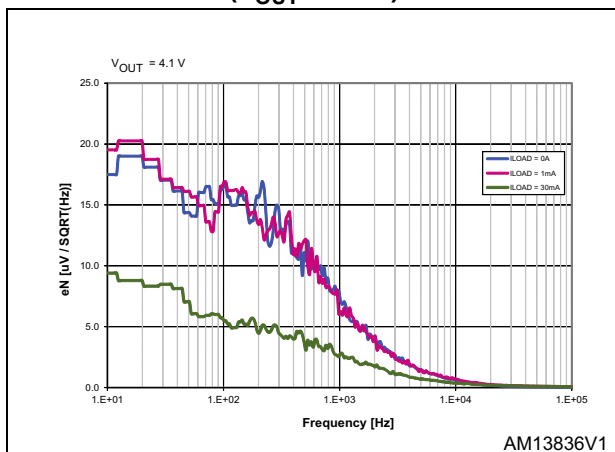

Figure 32. Stability plan vs. ( $C_{OUT}$ , ESR)

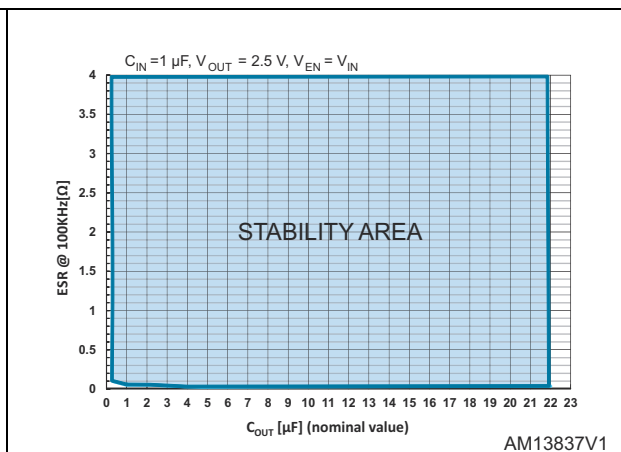



Figure 33. Startup by enable ( $I_{OUT} = 0 \text{ mA}$ , auto green mode)

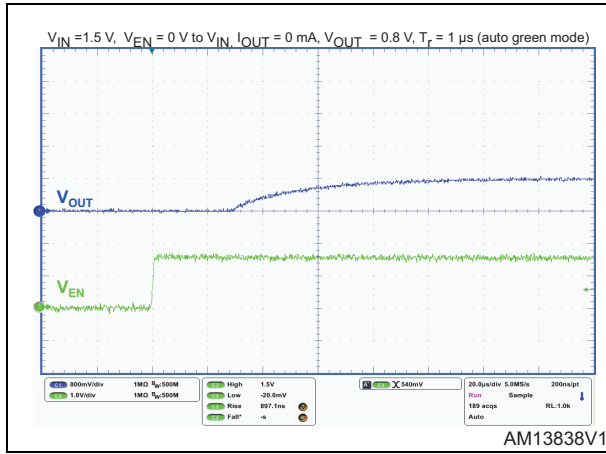

Figure 34. Turn-off by enable ( $I_{OUT} = 0 \text{ mA}$ , auto green mode)

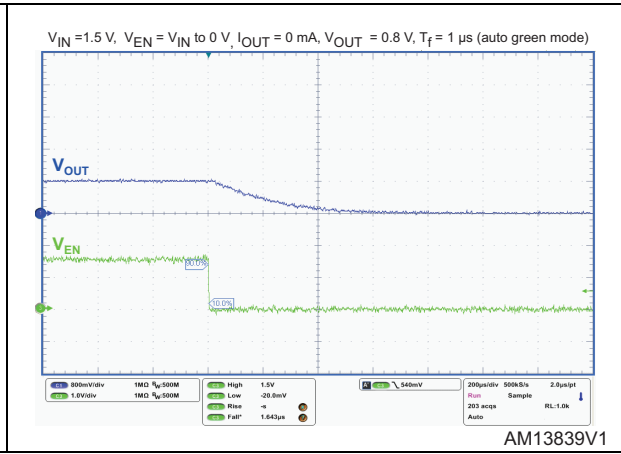

Figure 35. Startup by enable ( $I_{OUT} = 300 \text{ mA}$ , auto green mode)

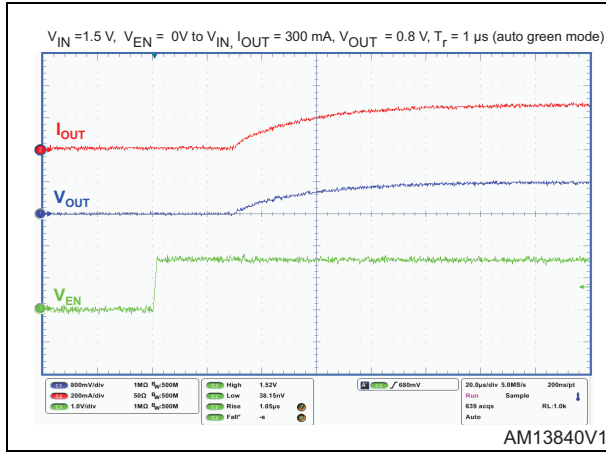

Figure 36. Turn-off by enable ( $I_{OUT} = 300 \text{ mA}$ , auto green mode)

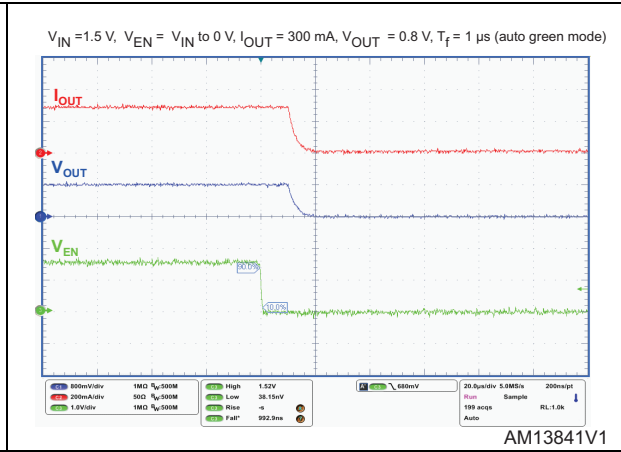

Figure 37. Startup by enable ( $I_{OUT} = 300 \text{ mA}$ , normal mode)

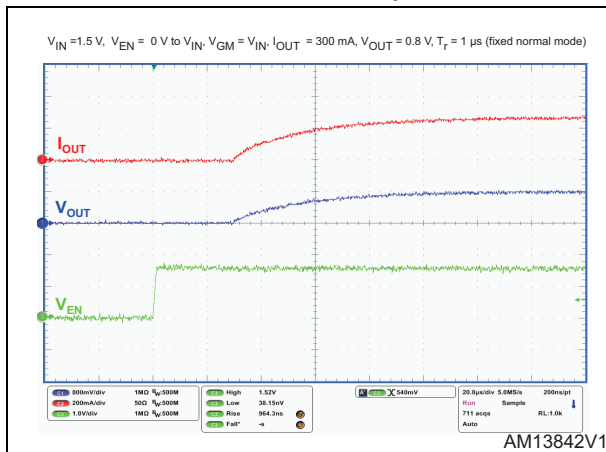

Figure 38. Turn-off by enable ( $I_{OUT} = 300 \text{ mA}$ , normal mode)

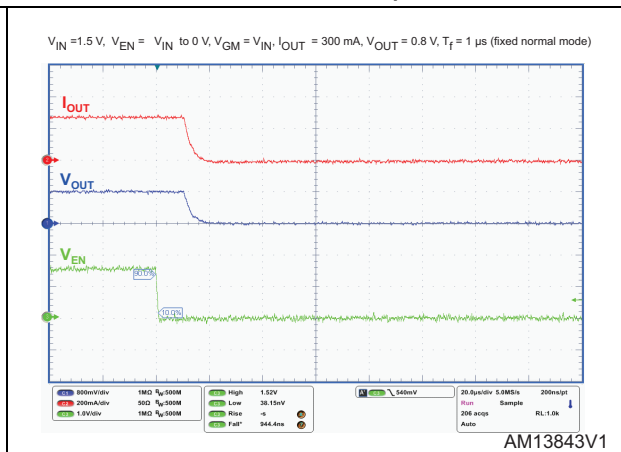

Figure 39. Turn-on time

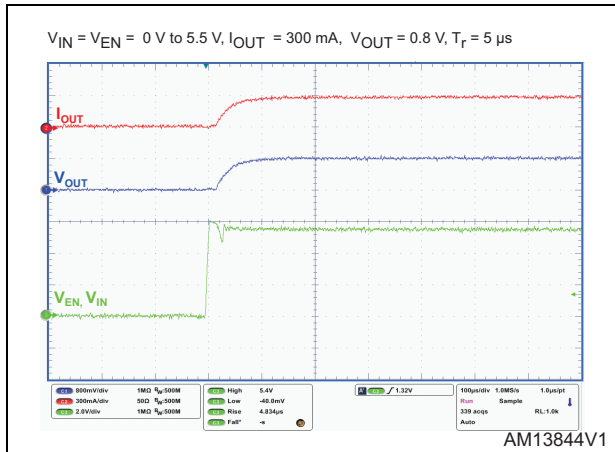

Figure 40. Turn-off time

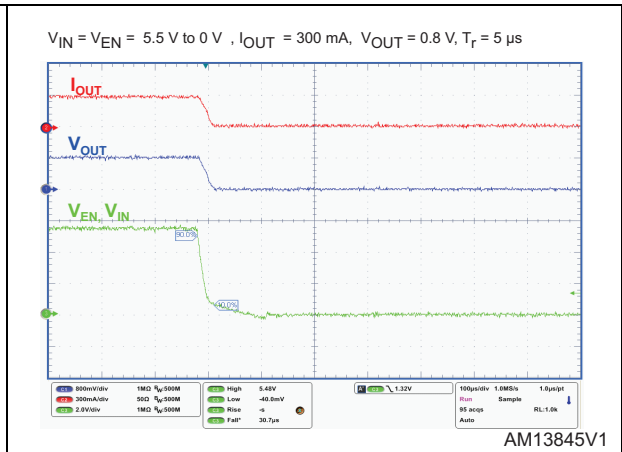

Figure 41. Line transient (auto green mode)

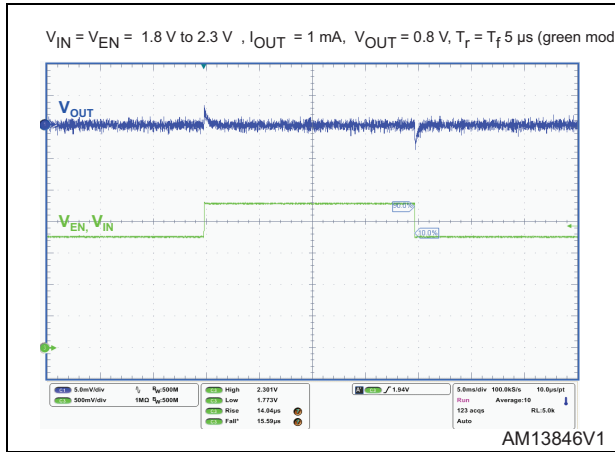

Figure 42. Line transient (normal mode)

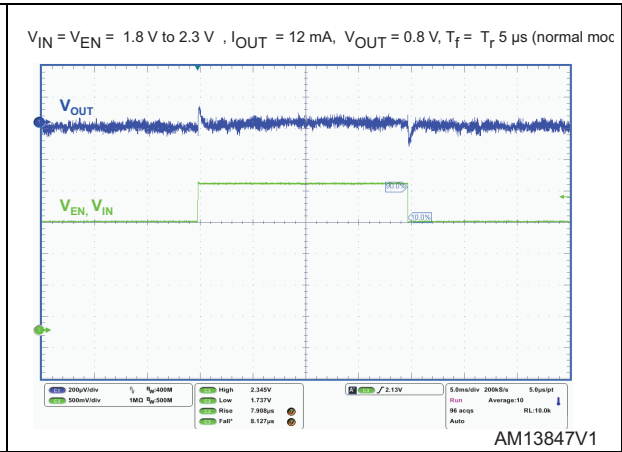

Figure 43. Load transient ( $I_{OUT} = 1$  to  $30\text{ mA}$ , auto green mode)

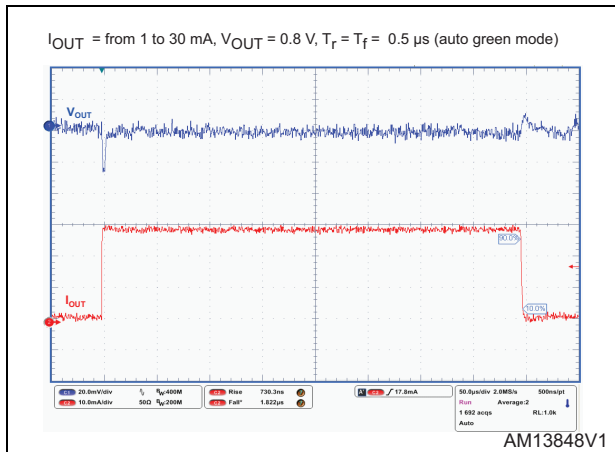

Figure 44. Load transient ( $I_{OUT} = 0$  to  $300\text{ mA}$ , auto green mode)

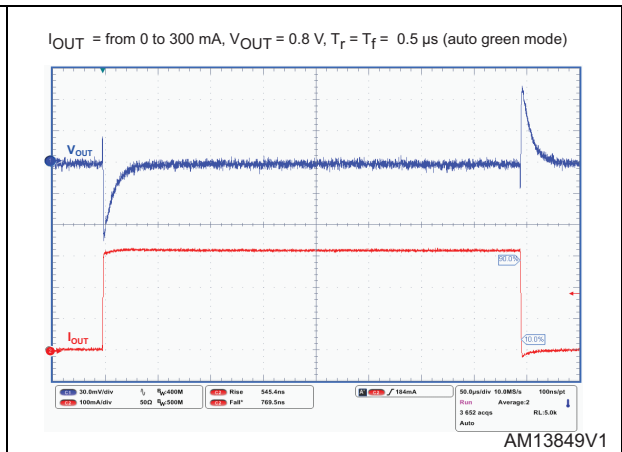

Figure 45. Load transient ( $I_{OUT} = 1$  to  $300$  mA, normal mode)

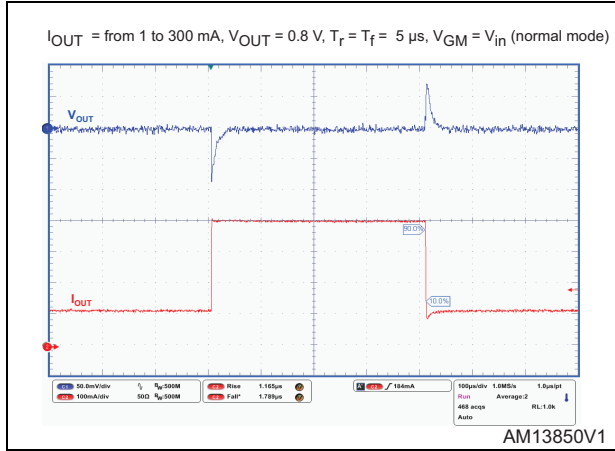
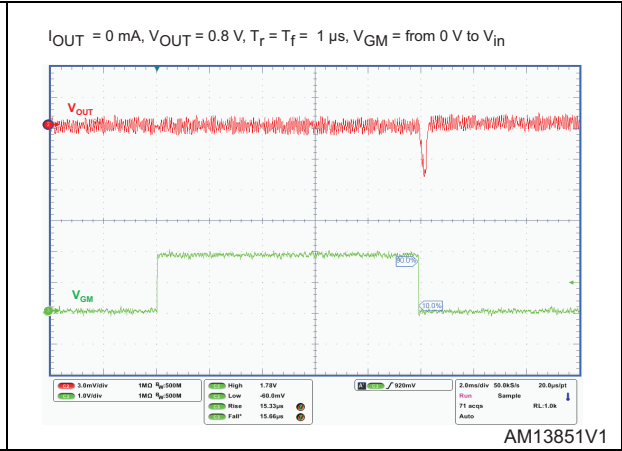

Figure 46. Green mode transient



## 7 Package mechanical data

In order to meet environmental requirements, ST offers these devices in different grades of ECOPACK<sup>®</sup> packages, depending on their level of environmental compliance. ECOPACK<sup>®</sup> specifications, grade definitions and product status are available at: [www.st.com](http://www.st.com). ECOPACK<sup>®</sup> is an ST trademark.

### 7.1 Flip-chip 4

Figure 47. Flip-chip 4 drawing

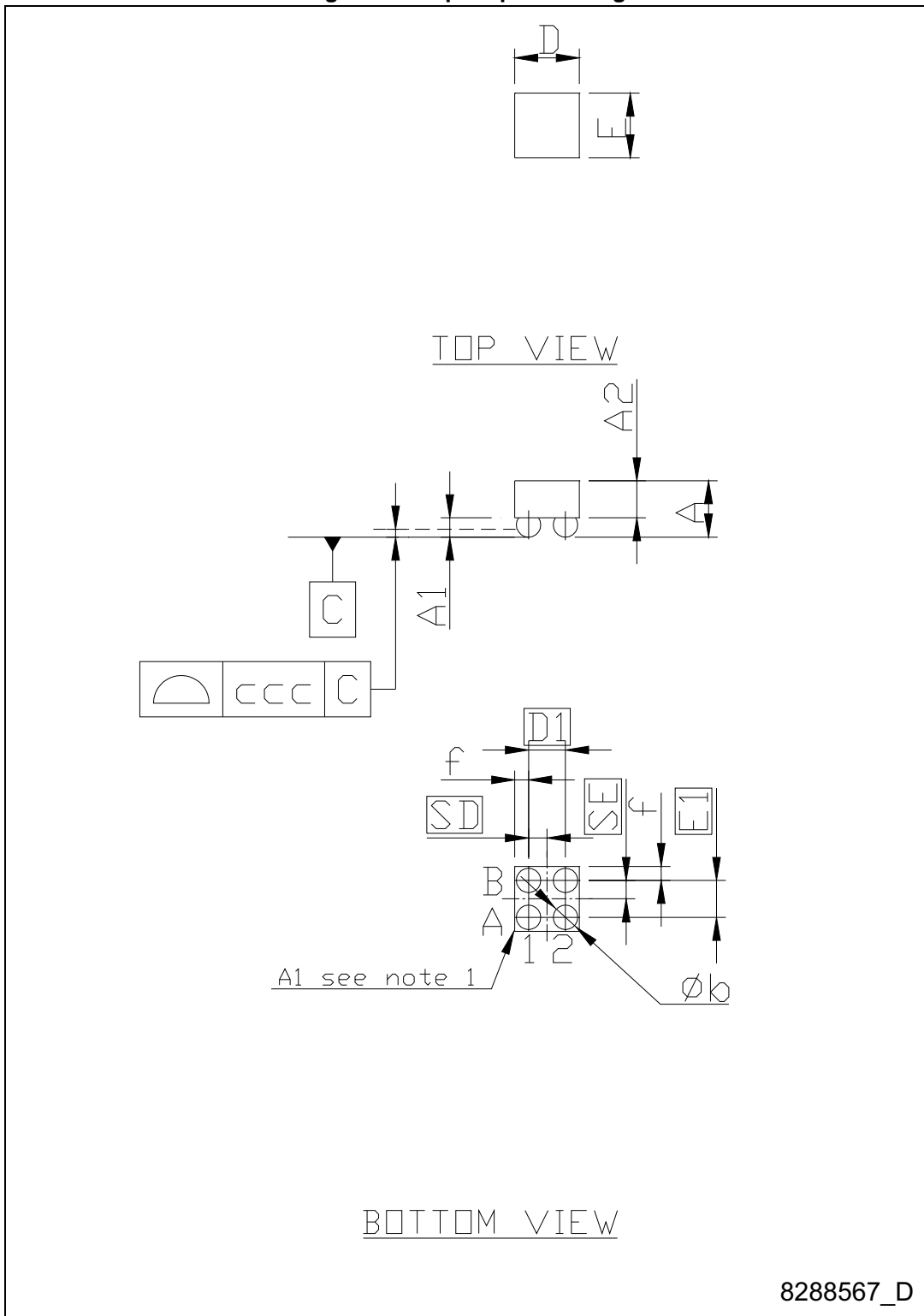

8288567\_D

Table 7. Flip-chip 4 mechanical data

Dim.	mm		
	Min.	Typ.	Max.
A	0.445	0.48	0.515
A1	0.065	0.08	0.095
A2	0.38	0.40	0.42
b	0.12	0.16	0.2
D	0.66	0.69	0.72
D1		0.40	
E	0.66	0.69	0.72
E1		0.40	
f	0.135	0.145	0.155
SD/SE		0.20	
ccc			0.02

Figure 48. Flip-chip 4 footprint

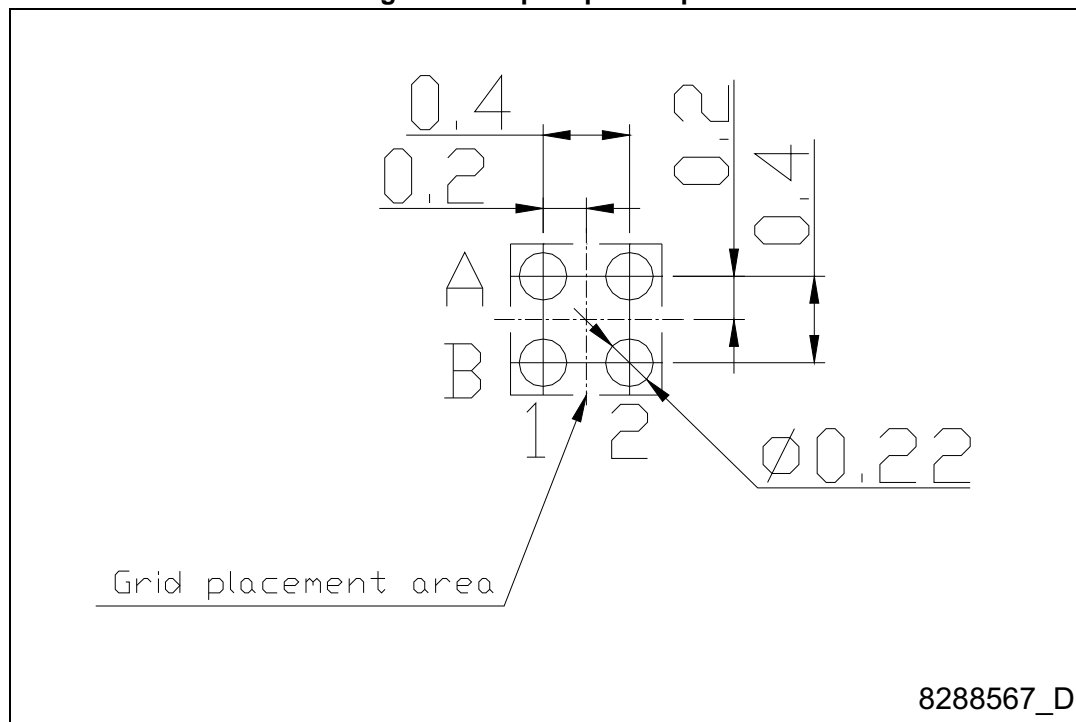

8288567\_D

### 7.2 DFN6 1.2x1.3 mm

Figure 49. DFN6 1.2x1.3 mm drawing

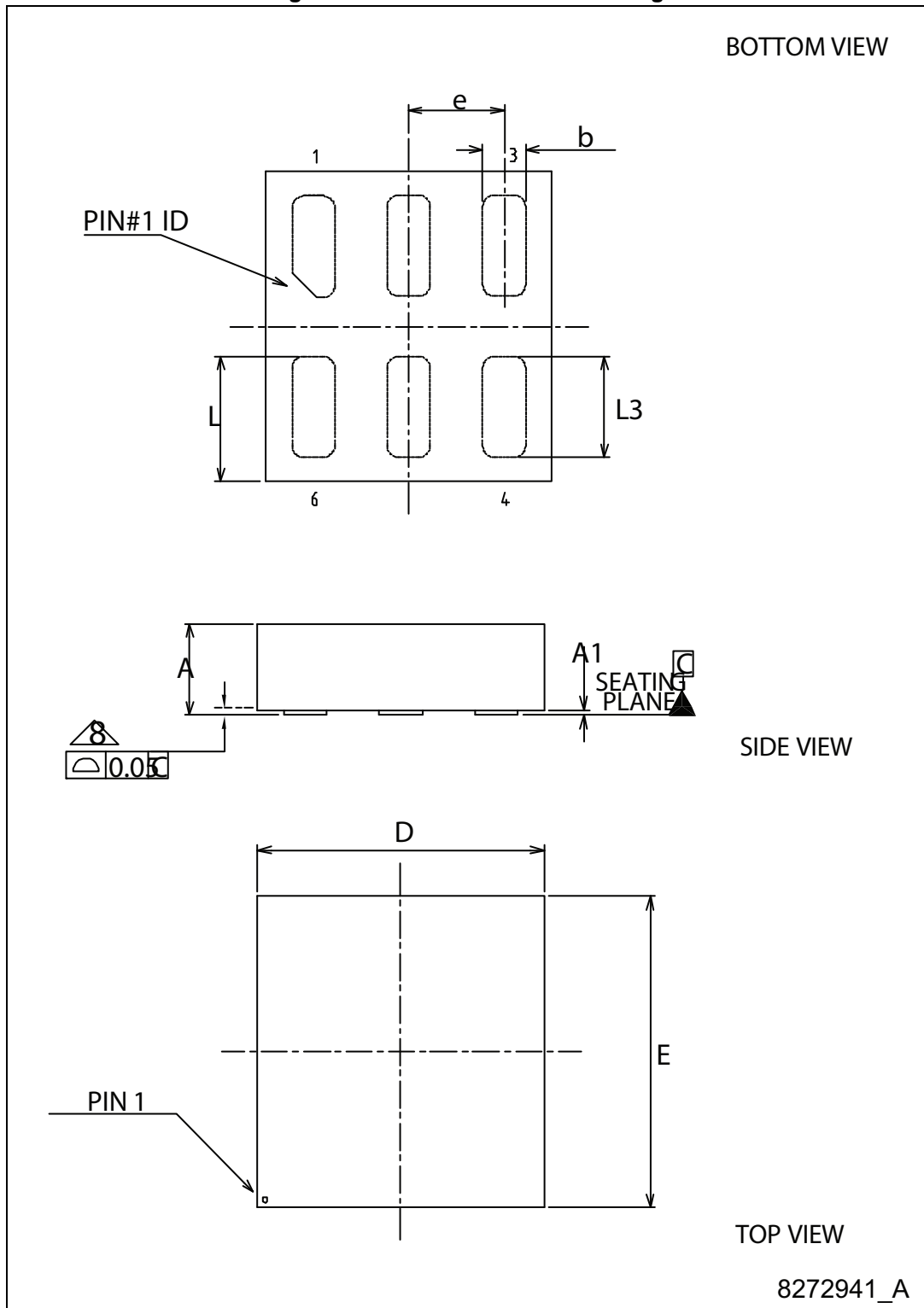
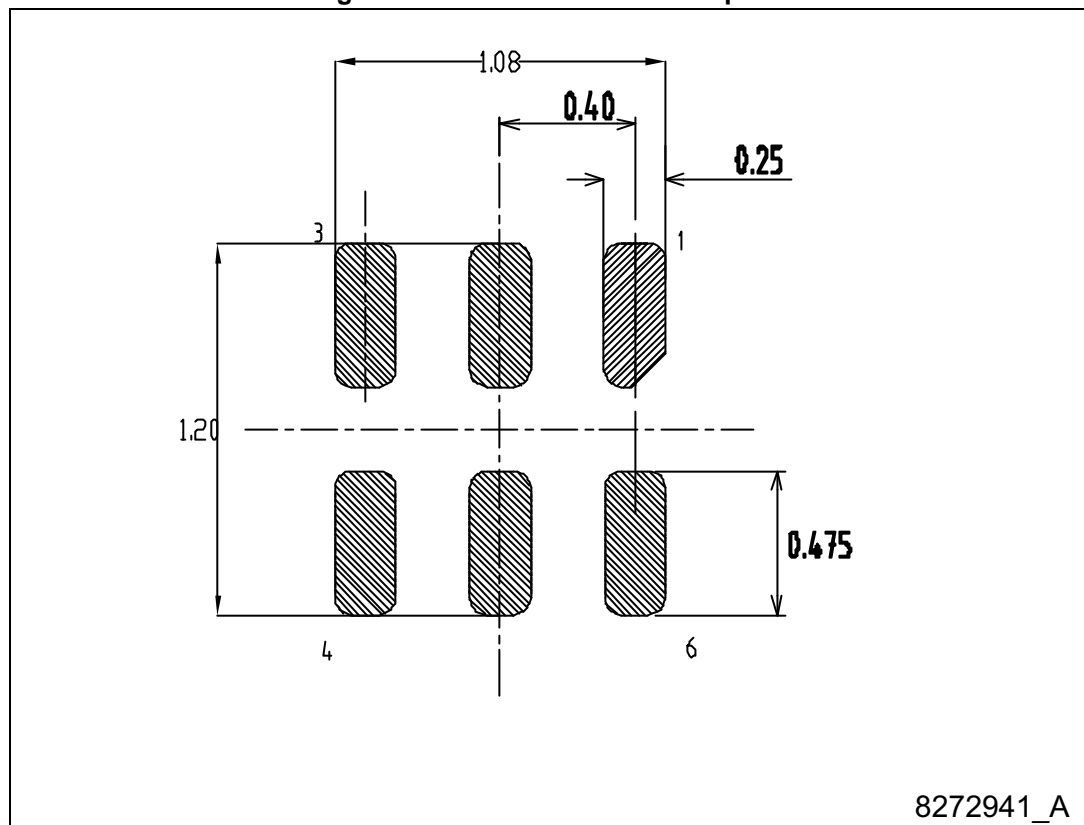

Table 8. DFN6 1.2x1.3 mm mechanical data

Dim.	mm		
	Min.	Typ.	Max.
A	0.31	0.38	0.40
A1	0	0.02	0.05
b	0.15	0.18	0.25
c		0.05	
D		1.20	
E		1.30	
e		0.40	
L	0.475	0.525	0.575
L3	0.375	0.425	0.475

Figure 50. DFN6 1.2x1.3 mm footprint





## 8 Order codes

Table 9. Order codes

Order codes		Output voltages (V)
DFN6 1.2x1.3 mm	Flip-chip 4	
LD39130SPUR		Adjustable
	LD39130SJ10R	1.0
	LD39130SJ12R	1.2
	LD39130SJ18R	1.8
	LD39130SJ25R	2.5
	LD39130SJ29R	2.9
	LD39130SJ30R	3.0
	LD39130SJ33R	3.3
	LD39130SJ41R	4.1

*Note:* Other output voltage versions available on request.

## 9 Revision history

**Table 10. Document revision history**

Date	Revision	Changes
08-Oct-2013	1	Initial release.
20-Jan-2015	2	Updated <i>Figure 19: Quiescent current vs. input voltage (auto green mode)</i> and <i>Figure 23: Quiescent current vs. load current (light load)</i> Updated <i>Table 3: Thermal data</i> , <i>Table 4: ESD performance</i> , <i>Table 5: LD39130S/LD39130SJ electrical characteristics (fixed versions)</i> , <i>Table 6: LD39130S electrical characteristics (adjustable version)</i> , <i>Figure 19: Quiescent current vs. input voltage (auto green mode)</i> , <i>Figure 23: Quiescent current vs. load current (light load)</i> , <i>Figure 39: Turn-on time</i> and <i>Figure 41: Line transient (auto green mode)</i> . Minor text changes.

**IMPORTANT NOTICE – PLEASE READ CAREFULLY**

STMicroelectronics NV and its subsidiaries ("ST") reserve the right to make changes, corrections, enhancements, modifications, and improvements to ST products and/or to this document at any time without notice. Purchasers should obtain the latest relevant information on ST products before placing orders. ST products are sold pursuant to ST's terms and conditions of sale in place at the time of order acknowledgement.

Purchasers are solely responsible for the choice, selection, and use of ST products and ST assumes no liability for application assistance or the design of Purchasers' products.

No license, express or implied, to any intellectual property right is granted by ST herein.

Resale of ST products with provisions different from the information set forth herein shall void any warranty granted by ST for such product.

ST and the ST logo are trademarks of ST. All other product or service names are the property of their respective owners.

Information in this document supersedes and replaces information previously supplied in any prior versions of this document.

© 2015 STMicroelectronics – All rights reserved

# Mouser Electronics

Authorized Distributor

Click to View Pricing, Inventory, Delivery & Lifecycle Information:

## STMicroelectronics:

[LD39130SJ33R](#) [LD39130SJ12R](#) [LD39130SJ29R](#) [LD39130SJ41R](#) [LD39130SJ10R](#) [LD39130SJ25R](#)  
[LD39130SJ18R](#) [LD39130SJ30R](#) [LD39130SPUR](#)