

N-channel 500 V, 0.24 Ω typ., 13 A MDmesh™ M2 Power MOSFETs in DPAK, TO-220FP and TO-220 packages

Datasheet - production data

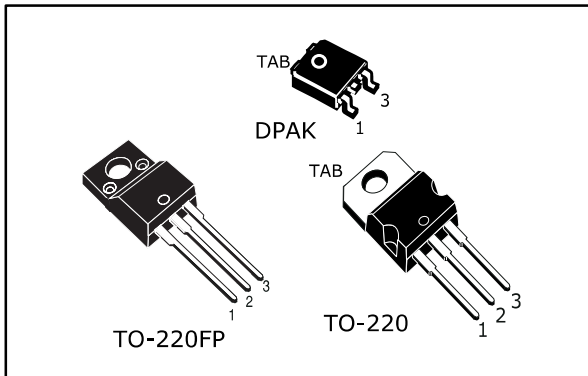
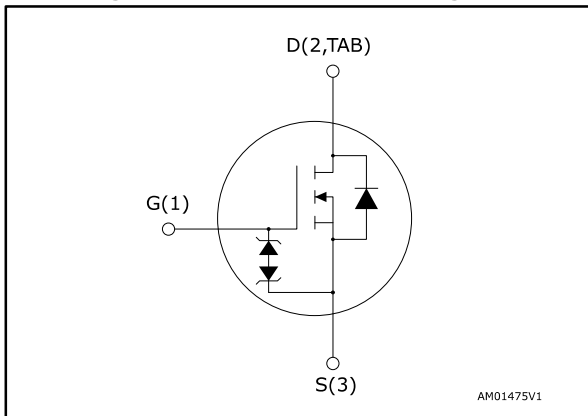

Figure 1: Internal schematic diagram



Features

Order code	V _{DS} @ T _{Jmax}	R _{DS(on)} max.	I _D
STD16N50M2	550 V	0.28 Ω	13 A
STF16N50M2			
STP16N50M2			

- Extremely low gate charge
- Excellent output capacitance (C_{oss}) profile
- 100% avalanche tested
- Zener-protected

Applications

- Switching applications

Description

These devices are N-channel Power MOSFETs developed using MDmesh™ M2 technology. Thanks to their strip layout and improved vertical structure, these devices exhibit low on-resistance and optimized switching characteristics, rendering them suitable for the most demanding high efficiency converters.

Table 1: Device summary

Order code	Marking	Package	Packing
STD16N50M2	16N60M2	DPAK	Tape and reel
STF16N50M2		TO-220FP	
STP16N50M2		TO-220	Tube

Contents

1	Electrical ratings	3
2	Electrical characteristics	4
	2.1 Electrical characteristics (curves).....	6
3	Test circuits	9
4	Package mechanical data	10
	4.1 DPAK (TO-252) type A2 package information.....	11
	4.2 DPAK (TO-252) packing information.....	14
	4.3 TO-220FP package information	16
	4.4 TO-220 type A package information.....	18
5	Revision history	20

1 Electrical ratings

Table 2: Absolute maximum ratings

Symbol	Parameter	Value			Unit
		DPAK	TO-220	TO-220FP	
V _{GS}	Gate-source voltage	± 25			V
I _D	Drain current (continuous) at T _C = 25 °C	13			A
I _D	Drain current (continuous) at T _C = 100 °C	8			A
I _{DM} ⁽¹⁾	Drain current (pulsed)	52			A
P _{TOT}	Total dissipation at T _C = 25 °C	110		25	W
dv/dt ⁽²⁾	Peak diode recovery voltage slope	15			V/ns
dv/dt ⁽³⁾	MOSFET dv/dt ruggedness	50			V/ns
V _{ISO}	Insulation withstand voltage (RMS) from all three leads to external heat sink (t = 1 s, T _C = 25 °C)			2500	V
T _{stg}	Storage temperature range	- 55 to 150			°C
T _j	Operating junction temperature range				

Notes:

- (1) Pulse width limited by safe operating area.
- (2) I_{SD} ≤ 13 A, di/dt ≤ 400 A/μs; V_{DS peak} < V_{(BR)DSS}, V_{DD} = 80% V_{(BR)DSS}
- (3) V_{DS} ≤ 400 V

Table 3: Thermal data

Symbol	Parameter	Value			Unit
		DPAK	TO-220	TO-220FP	
R _{thj-case}	Thermal resistance junction-case max.	1.14		5	°C/W
R _{thj-amb}	Thermal resistance junction-ambient max.		62.5		
R _{thj-pcb} ⁽¹⁾	Thermal resistance junction-pcb max.	50			

Notes:

- (1)When mounted on 1 inch² FR-4, 2 Oz copper board.

Table 4: Avalanche characteristics

Symbol	Parameter	Value	Unit
I _{AR}	Avalanche current, repetitive or not repetitive (pulse width limited by T _{jmax})	4	A
E _{AS}	Single pulse avalanche energy (starting T _j = 25 °C, I _D = I _{AR} , V _{DD} = 50 V)	215	mJ

2 Electrical characteristics

(T_C = 25 °C unless otherwise specified).

Table 5: On /off states

Symbol	Parameter	Test conditions	Min.	Typ.	Max.	Unit
V _{(BR)DSS}	Drain-source breakdown voltage	V _{GS} = 0 V, I _D = 1 mA	500			V
I _{DSS}	Zero gate voltage drain current	V _{GS} = 0 V, V _{DS} = 500 V			1	μA
		V _{GS} = 0 V, V _{DS} = 500 V, T _C = 125 °C ⁽¹⁾			100	μA
I _{GSS}	Gate-body leakage current	V _{DS} = 0 V, V _{GS} = ±25 V			±10	μA
V _{GS(th)}	Gate threshold voltage	V _{DS} = V _{GS} , I _D = 250 μA	2	3	4	V
R _{DS(on)}	Static drain-source on-resistance	V _{GS} = 10 V, I _D = 6.5 A		0.24	0.28	Ω

Notes:

⁽¹⁾Defined by design, not subject to production test.

Table 6: Dynamic

Symbol	Parameter	Test conditions	Min.	Typ.	Max.	Unit
C _{iss}	Input capacitance	V _{DS} = 100 V, f = 1 MHz, V _{GS} = 0 V	-	710	-	pF
C _{oss}	Output capacitance		-	44	-	pF
C _{rss}	Reverse transfer capacitance		-	1.35	-	pF
C _{oss eq.} ⁽¹⁾	Equivalent output capacitance	V _{DS} = 0 V to 400 V, V _{GS} = 0 V	-	192	-	pF
R _G	Intrinsic gate resistance	f = 1 MHz, I _D = 0 A	-	5.2	-	Ω
Q _g	Total gate charge	V _{DD} = 400 V, I _D = 13 A, V _{GS} = 10 V (see Figure 19: "Test circuit for gate charge behavior")	-	19.5	-	nC
Q _{gs}	Gate-source charge		-	4	-	nC
Q _{gd}	Gate-drain charge		-	8	-	nC

Notes:

⁽¹⁾ C_{oss eq.} is defined as a constant equivalent capacitance giving the same charging time as C_{oss} when V_{DS} increases from 0 to 80% V_{DSS}.

Table 7: Switching times

Symbol	Parameter	Test conditions	Min.	Typ.	Max.	Unit
t _{d(on)}	Turn-on delay time	V _{DD} = 250 V, I _D = 6.5 A R _G = 4.7 Ω, V _{GS} = 10 V (see Figure 18: "Test circuit for resistive load switching times" and Figure 23: "Switching time waveform")	-	9.6	-	ns
t _r	Rise time		-	7.6	-	ns
t _{d(off)}	Turn-off-delay time		-	32	-	ns
t _f	Fall time		-	10	-	ns

Table 8: Source-drain diode

Symbol	Parameter	Test conditions	Min.	Typ.	Max.	Unit
I_{SD}	Source-drain current		-		13	A
$I_{SDM}^{(1)}$	Source-drain current (pulsed)		-		52	A
$V_{SD}^{(2)}$	Forward on voltage	$V_{GS} = 0\text{ V}$, $I_{SD} = 13\text{ A}$	-		1.6	V
t_{rr}	Reverse recovery time	$I_{SD} = 13\text{ A}$, $di/dt = 100\text{ A}/\mu\text{s}$, $V_{DD} = 60\text{ V}$ (see Figure 20: "Test circuit for inductive load switching and diode recovery times")	-	280		ns
Q_{rr}	Reverse recovery charge		-	2.85		μC
I_{RRM}	Reverse recovery current		-	20.5		A
t_{rr}	Reverse recovery time	$I_{SD} = 13\text{ A}$, $di/dt = 100\text{ A}/\mu\text{s}$, $V_{DD} = 60\text{ V}$, $T_j = 150\text{ }^\circ\text{C}$ (see Figure 20: "Test circuit for inductive load switching and diode recovery times")	-	388		ns
Q_{rr}	Reverse recovery charge		-	4.5		μC
I_{RRM}	Reverse recovery current		-	21		A

Notes:

(1)Pulse width is limited by safe operating area.

(2)Pulse test: pulse duration = 300 μs , duty cycle 1.5%.

2.2 Electrical characteristics (curves)

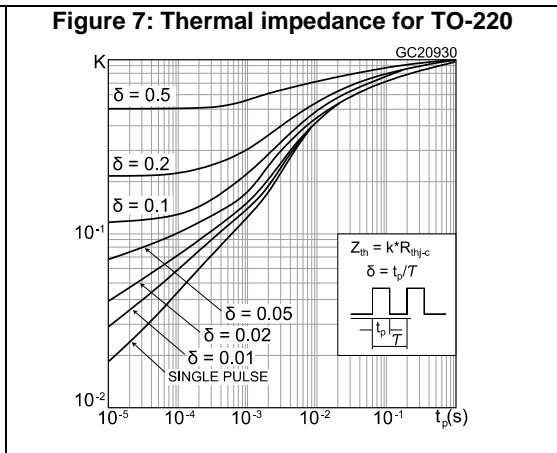
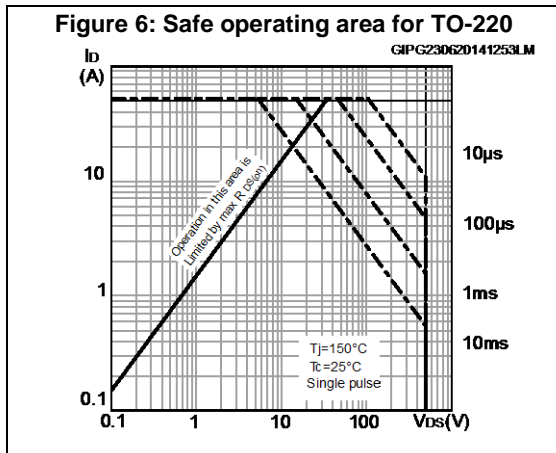
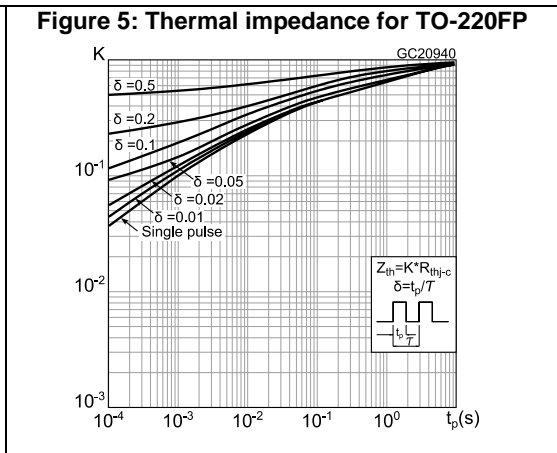
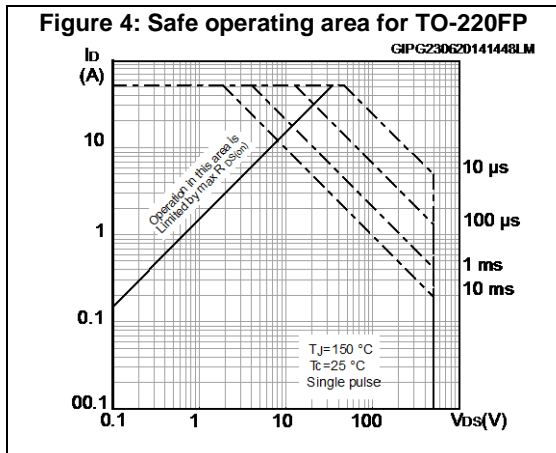
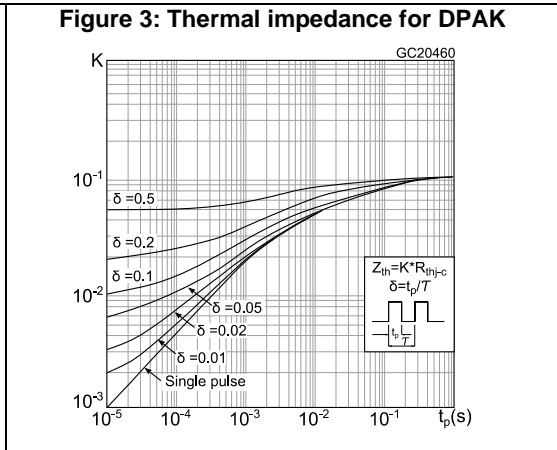
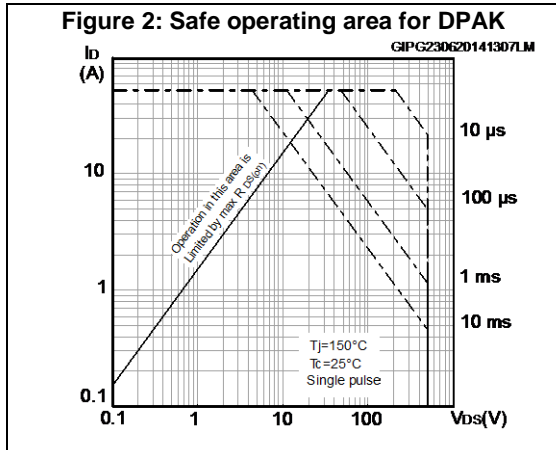

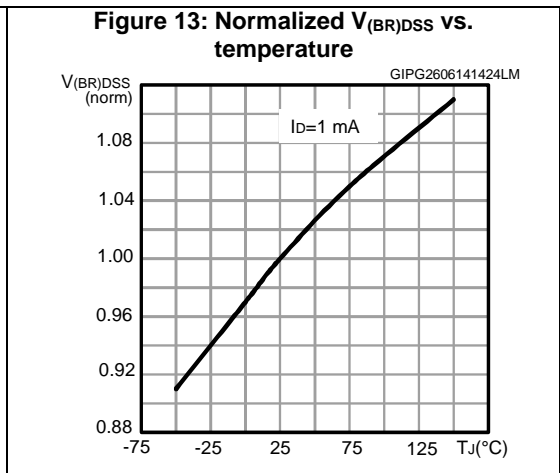
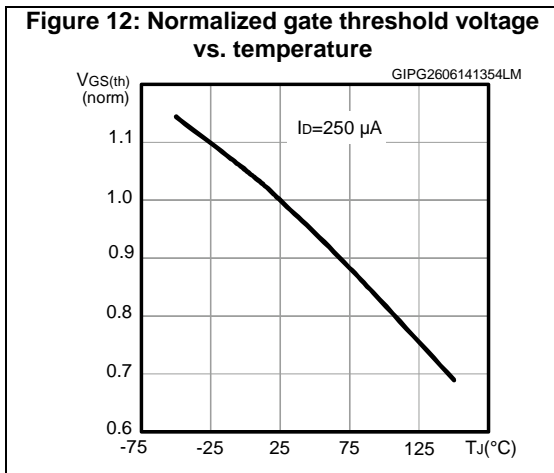
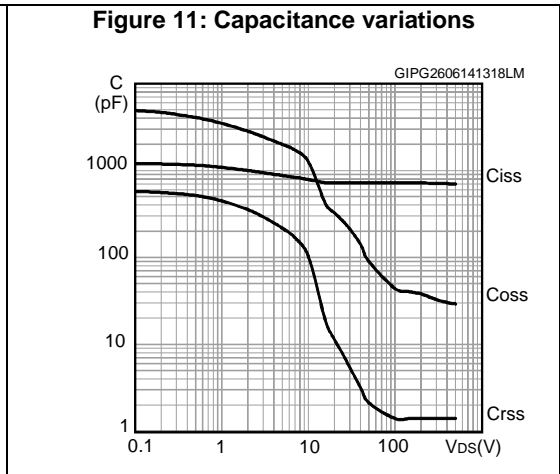
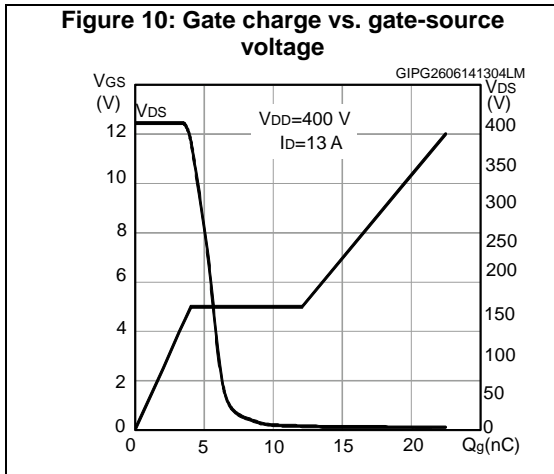
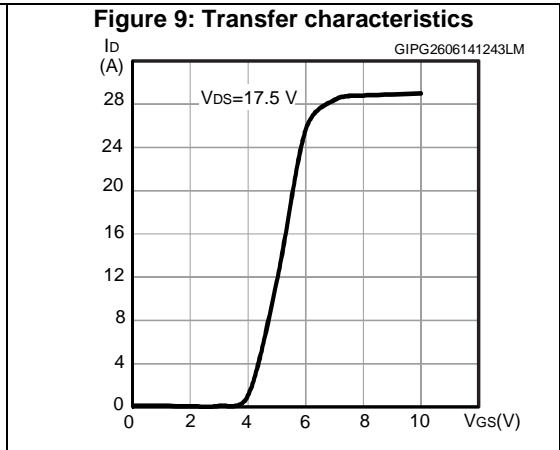
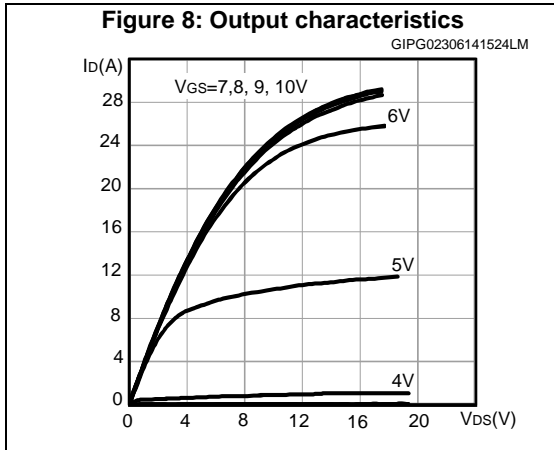

Figure 14: Static drain-source on-resistance

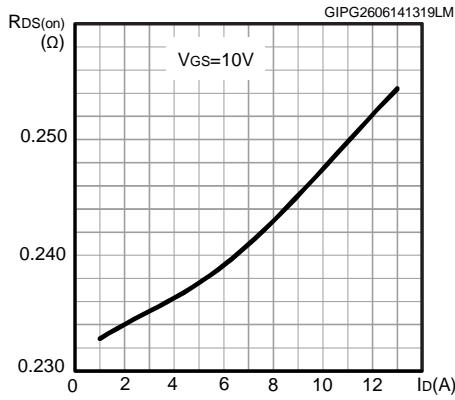

Figure 15: Normalized on-resistance vs. temperature

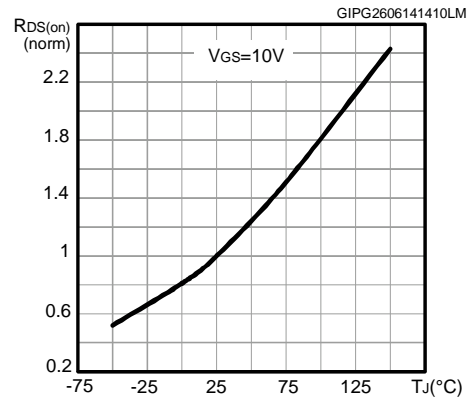

Figure 16: Output capacitance stored energy

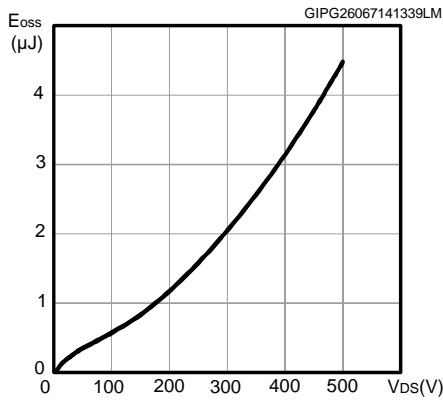
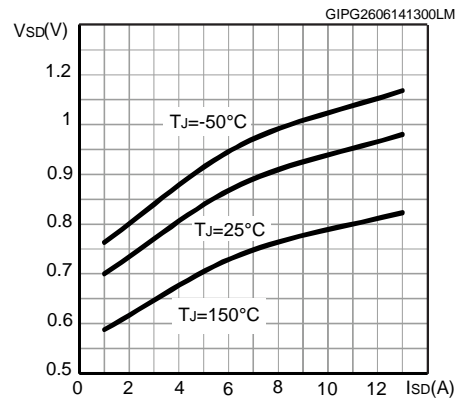
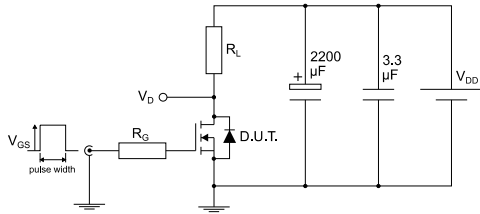

Figure 17: Source-drain diode forward characteristics



3 Test circuits

Figure 18: Test circuit for resistive load switching times



AM01468v1

Figure 19: Test circuit for gate charge behavior



AM01469v1

Figure 20: Test circuit for inductive load switching and diode recovery times

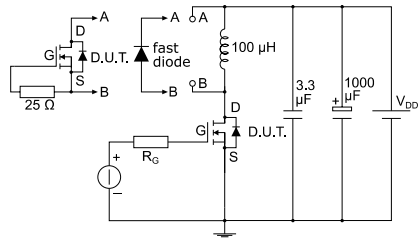

AM01470v1

Figure 21: Unclamped inductive load test circuit

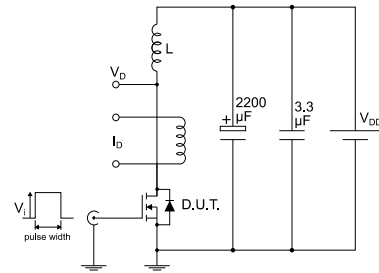

AM01471v1

Figure 22: Unclamped inductive waveform

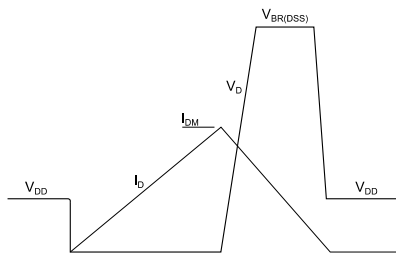

AM01472v1

Figure 23: Switching time waveform

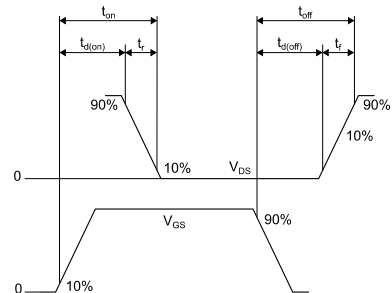

AM01473v1

4 Package mechanical data

In order to meet environmental requirements, ST offers these devices in different grades of ECOPACK® packages, depending on their level of environmental compliance. ECOPACK® specifications, grade definitions and product status are available at: www.st.com. ECOPACK® is an ST trademark.

4.1 DPAK (TO-252) type A2 package information

Figure 24: DPAK (TO-252) type A2 package outline

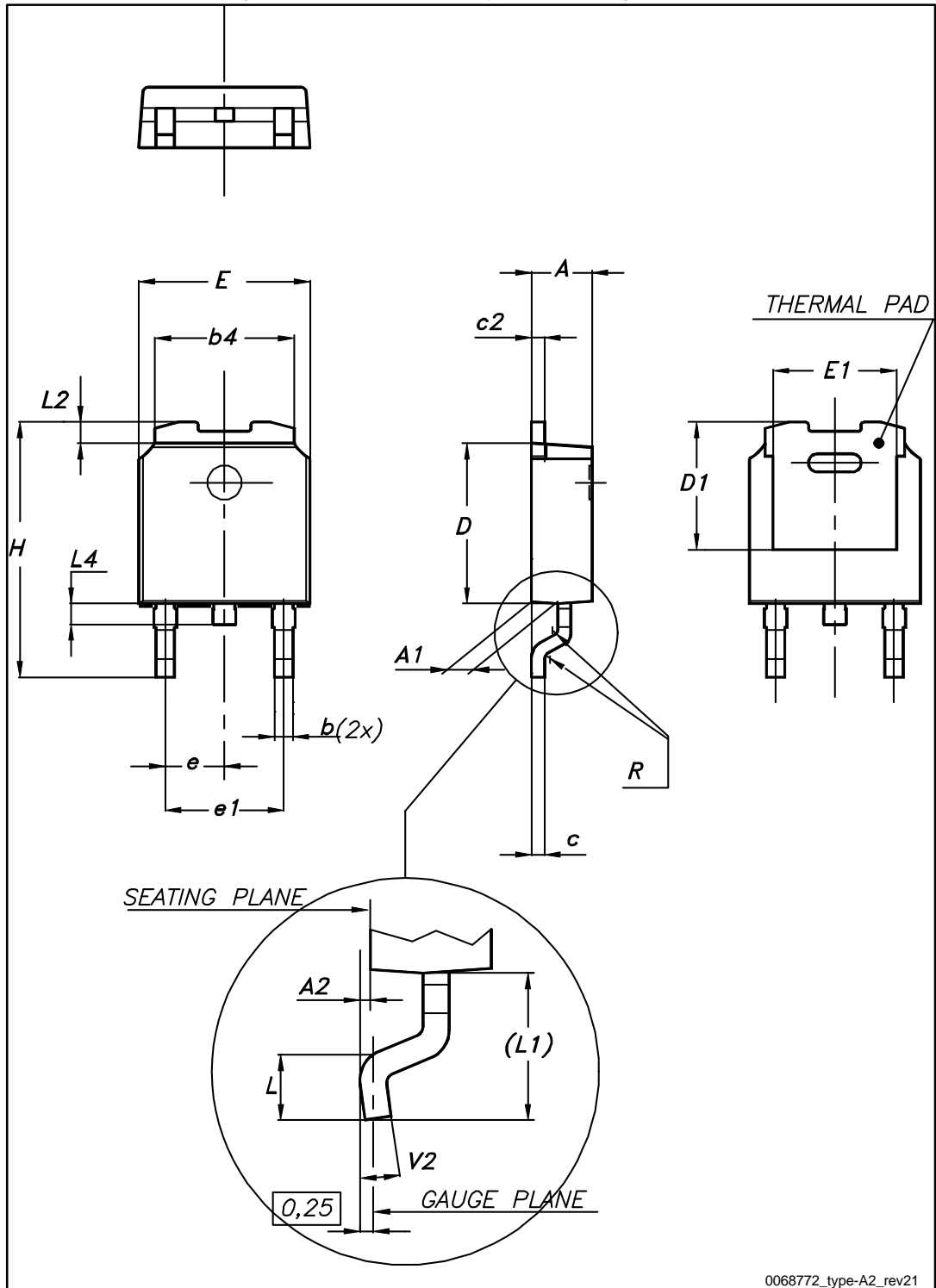
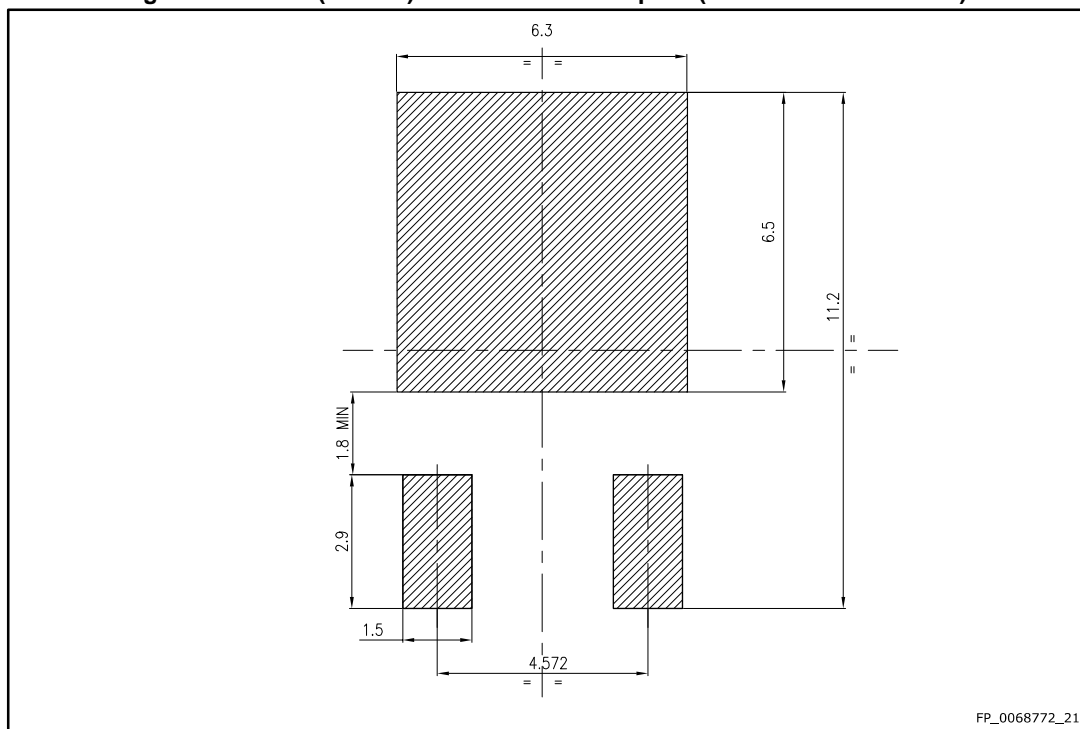

Table 9: DPAK (TO-252) type A2 mechanical data

Dim.	mm		
	Min.	Typ.	Max.
A	2.20		2.40
A1	0.90		1.10
A2	0.03		0.23
b	0.64		0.90
b4	5.20		5.40
c	0.45		0.60
c2	0.48		0.60
D	6.00		6.20
D1	4.95	5.10	5.25
E	6.40		6.60
E1	5.10	5.20	5.30
e	2.16	2.28	2.40
e1	4.40		4.60
H	9.35		10.10
L	1.00		1.50
L1	2.60	2.80	3.00
L2	0.65	0.80	0.95
L4	0.60		1.00
R		0.20	
V2	0°		8°

Figure 25: DPAK (TO-252) recommended footprint (dimensions are in mm)



4.2 DPAK (TO-252) packing information

Figure 26: DPAK (TO-252) tape outline

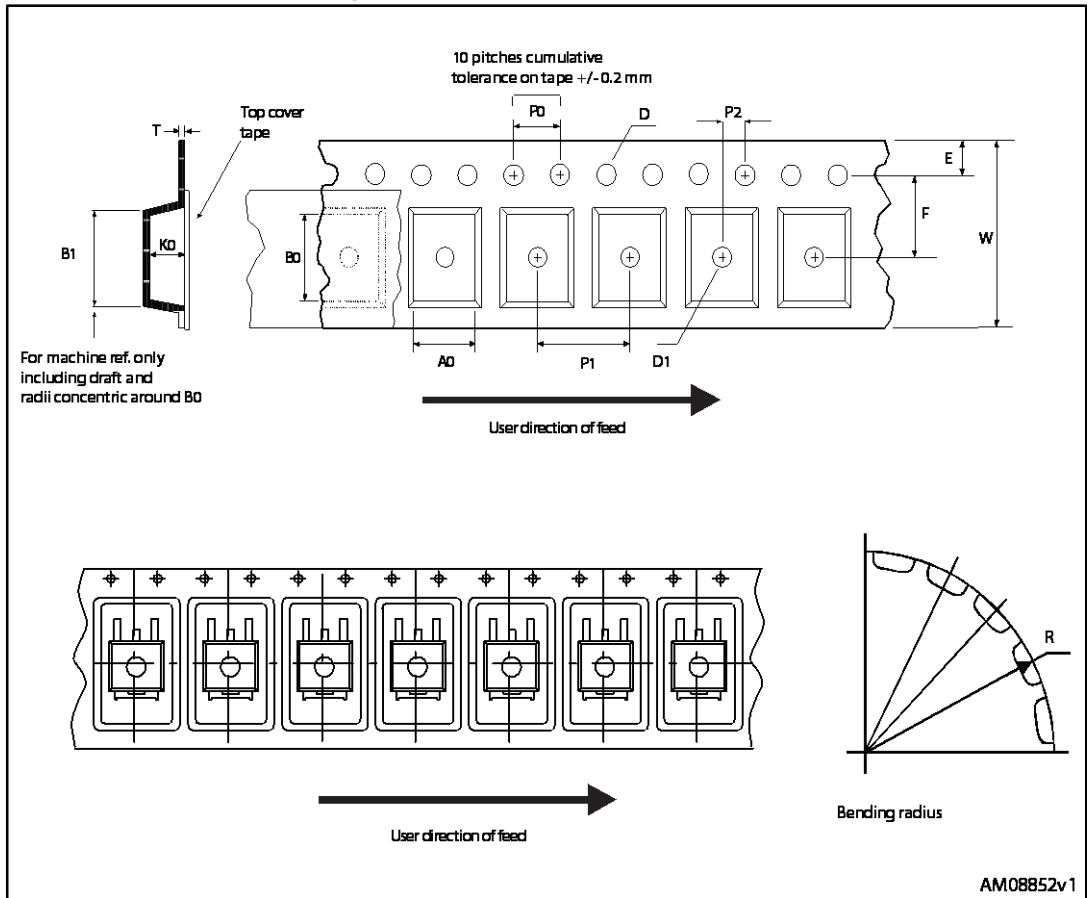
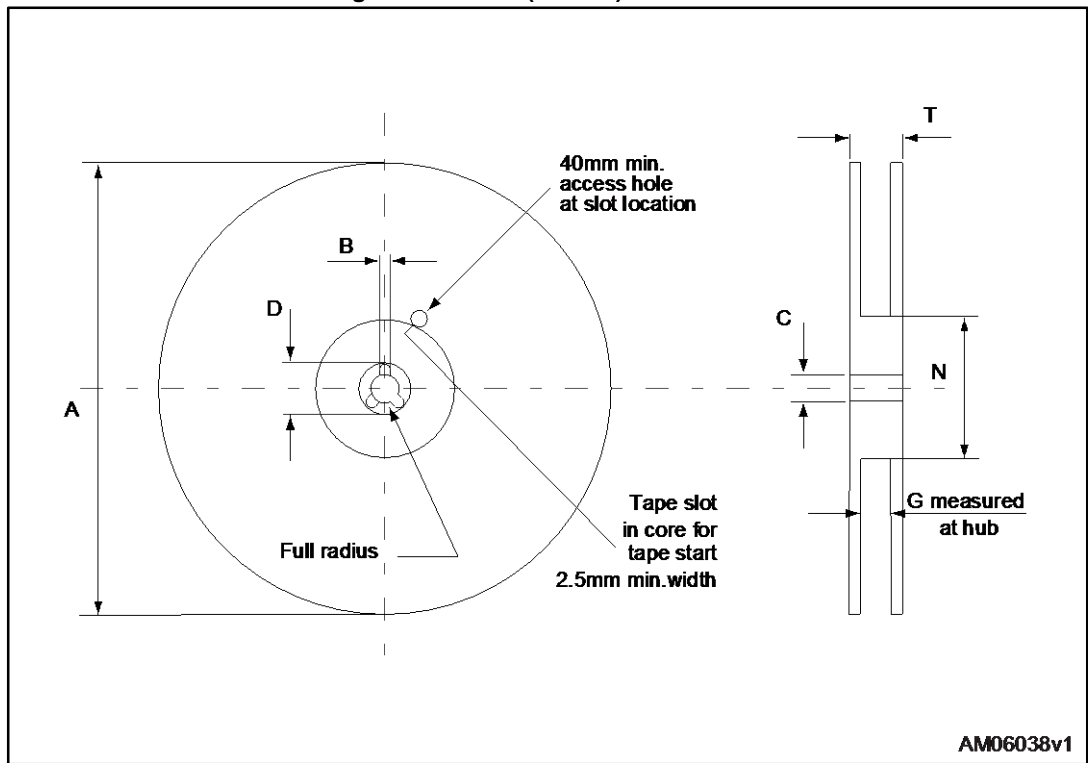

Figure 27: DPAK (TO-252) reel outline



AM06038v1

Table 10: DPAK (TO-252) tape and reel mechanical data

Tape			Reel		
Dim.	mm		Dim.	mm	
	Min.	Max.		Min.	Max.
A0	6.8	7	A		330
B0	10.4	10.6	B	1.5	
B1		12.1	C	12.8	13.2
D	1.5	1.6	D	20.2	
D1	1.5		G	16.4	18.4
E	1.65	1.85	N	50	
F	7.4	7.6	T		22.4
K0	2.55	2.75			
P0	3.9	4.1	Base qty.		2500
P1	7.9	8.1	Bulk qty.		2500
P2	1.9	2.1			
R	40				
T	0.25	0.35			
W	15.7	16.3			

4.3 TO-220FP package information

Figure 28: TO-220FP package outline

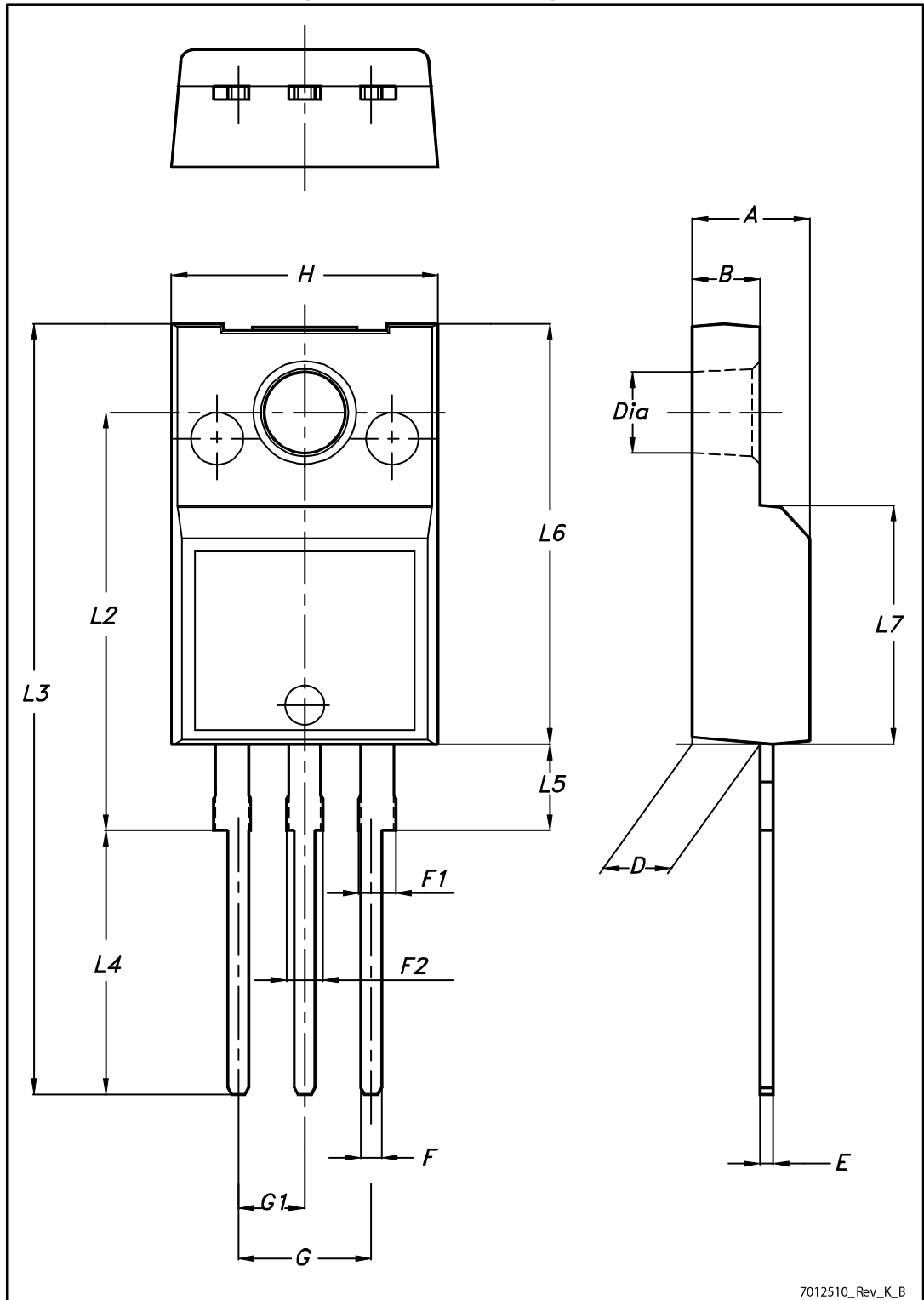

7012510_Rev_K_B

Table 11: TO-220FP package mechanical data

Dim.	mm		
	Min.	Typ.	Max.
A	4.4		4.6
B	2.5		2.7
D	2.5		2.75
E	0.45		0.7
F	0.75		1
F1	1.15		1.70
F2	1.15		1.70
G	4.95		5.2
G1	2.4		2.7
H	10		10.4
L2		16	
L3	28.6		30.6
L4	9.8		10.6
L5	2.9		3.6
L6	15.9		16.4
L7	9		9.3
Dia	3		3.2

4.4 TO-220 type A package information

Figure 29: TO-220 type A package outline

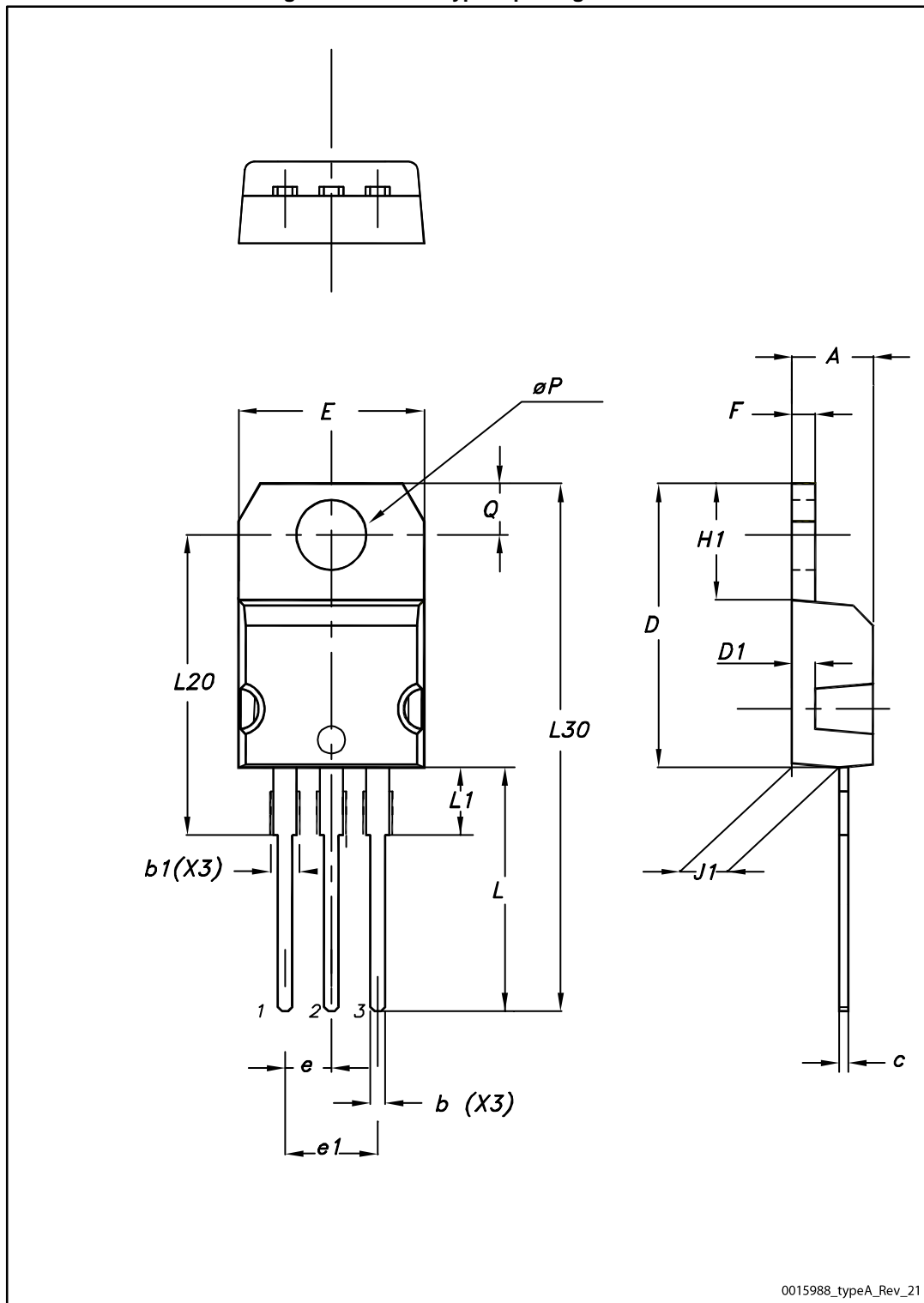

Table 12: TO-220 type A mechanical data

Dim.	mm		
	Min.	Typ.	Max.
A	4.40		4.60
b	0.61		0.88
b1	1.14		1.55
c	0.48		0.70
D	15.25		15.75
D1		1.27	
E	10.00		10.40
e	2.40		2.70
e1	4.95		5.15
F	1.23		1.32
H1	6.20		6.60
J1	2.40		2.72
L	13.00		14.00
L1	3.50		3.93
L20		16.40	
L30		28.90	
øP	3.75		3.85
Q	2.65		2.95

5 Revision history

Table 13: Document revision history

Date	Revision	Changes
04-Jul-2014	1	Initial release.
18-Jul-2014	2	Updated <i>Figure 9</i> .
31-Jul-2014	3	Updated <i>Figure 2</i> and <i>Figure 4</i> .
25-Aug-2016	4	Datasheet promoted from preliminary data to production data Changed: Section 4.1: "DPAK (TO-252) type A2 package information" Minor text changes

IMPORTANT NOTICE – PLEASE READ CAREFULLY

STMicroelectronics NV and its subsidiaries ("ST") reserve the right to make changes, corrections, enhancements, modifications, and improvements to ST products and/or to this document at any time without notice. Purchasers should obtain the latest relevant information on ST products before placing orders. ST products are sold pursuant to ST's terms and conditions of sale in place at the time of order acknowledgement.

Purchasers are solely responsible for the choice, selection, and use of ST products and ST assumes no liability for application assistance or the design of Purchasers' products.

No license, express or implied, to any intellectual property right is granted by ST herein.

Resale of ST products with provisions different from the information set forth herein shall void any warranty granted by ST for such product.

ST and the ST logo are trademarks of ST. All other product or service names are the property of their respective owners.

Information in this document supersedes and replaces information previously supplied in any prior versions of this document.

© 2016 STMicroelectronics – All rights reserved

Mouser Electronics

Authorized Distributor

Click to View Pricing, Inventory, Delivery & Lifecycle Information:

[STMicroelectronics:](#)

[STD16N50M2](#) [STF16N50M2](#) [STP16N50M2](#)