



# STD35NF06L

## N-channel 60 V, 0.014 $\Omega$ , 35 A STripFET™ II Power MOSFET in a DPAK package

Datasheet — production data

### Features

Order code	V <sub>DSS</sub>	R <sub>DS(on)</sub>	I <sub>D</sub>
STD35NF06LT4	60V	<0.017 $\Omega$	35A

- Low threshold drive
- Gate charge minimized

### Applications

- Switching application

### Description

This Power MOSFET has been developed using STMicroelectronics' unique STripFET process, which is specifically designed to minimize input capacitance and gate charge. This renders the device suitable for use as primary switch in advanced high-efficiency isolated DC-DC converters for telecom and computer applications, and applications with low gate charge driving requirements.

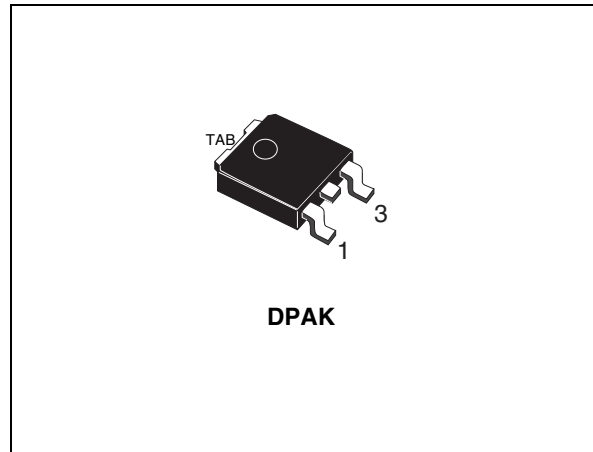

Figure 1. Internal schematic diagram

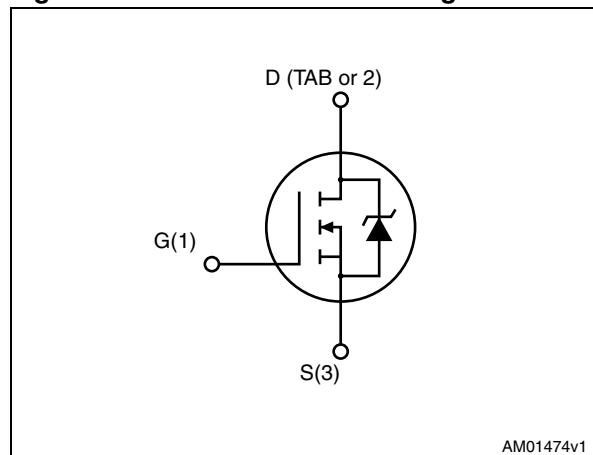

Table 1. Device summary

Order code	Marking	Package	Packaging
STD35NF06LT4	D35NF06L	DPAK	Tape and reel

# Contents

<b>1</b>	<b>Electrical ratings</b> .....	<b>3</b>
<b>2</b>	<b>Electrical characteristics</b> .....	<b>4</b>
	2.1 Electrical characteristics (curves) .....	6
<b>3</b>	<b>Test circuit</b> .....	<b>8</b>
<b>4</b>	<b>Package mechanical data</b> .....	<b>9</b>
<b>5</b>	<b>Packing mechanical data</b> .....	<b>11</b>
<b>6</b>	<b>Revision history</b> .....	<b>13</b>

# 1 Electrical ratings

**Table 2. Absolute maximum ratings**

Symbol	Parameter	Value	Unit
$V_{DS}$	Drain-source voltage	60	V
$V_{DGR}$	Drain-gate voltage ( $R_{GS} = 20\text{ k}\Omega$ )	60	V
$V_{GS}$	Gate- source voltage	$\pm 16$	V
$I_D$	Drain current (continuous) at $T_C = 25\text{ }^\circ\text{C}$	35	A
$I_D$	Drain current (continuous) at $T_C = 100\text{ }^\circ\text{C}$	24.5	A
$I_{DM}^{(1)}$	Drain current (pulsed)	140	A
$P_{tot}$	Total dissipation at $T_C = 25\text{ }^\circ\text{C}$	80	W
	Derating Factor	0.53	W/ $^\circ\text{C}$
$dv/dt^{(2)}$	Peak diode recovery avalanche energy	5	V/ns
$E_{AS}^{(3)}$	Single pulse avalanche energy	280	mJ
$T_{stg}$	Storage temperature	-55 to 175	$^\circ\text{C}$
$T_j$	Max. operating junction temperature		

1. Pulse width limited by safe operating area.
2.  $I_{SD} \leq 35\text{ A}$ ,  $di/dt \leq 100\text{ A}/\mu\text{s}$ ,  $V_{DD} = V_{(BR)DSS}$ ,  $T_j \leq T_{JMAX}$
3. Starting  $T_j = 25\text{ }^\circ\text{C}$ ,  $I_D = 30\text{ A}$ ,  $V_{DD} = 30\text{ V}$

**Table 3. Thermal data**

Symbol	Parameter	Value	Unit
$R_{thj-case}$	Thermal resistance junction-case max	1.88	$^\circ\text{C}/\text{W}$
$R_{thj-amb}$	Thermal resistance junction-to ambient max	100	$^\circ\text{C}/\text{W}$
$T_J$	Maximum lead temperature for soldering purpose	275	$^\circ\text{C}$

## 2 Electrical characteristics

( $T_{CASE} = 25\text{ °C}$  unless otherwise specified)

**Table 4. On/off states**

Symbol	Parameter	Test conditions	Min.	Typ.	Max.	Unit
$V_{(BR)DSS}$	Drain-source breakdown voltage	$I_D = 250\ \mu\text{A}$ , $V_{GS} = 0$	60			V
$I_{DSS}$	Zero gate voltage drain current ( $V_{GS} = 0$ )	$V_{DS} = 60\text{ V}$ $V_{DS} = 60\text{ V}$ , $T_C = 125\text{ °C}$			1 10	$\mu\text{A}$ $\mu\text{A}$
$I_{GSS}$	Gate-body leakage current ( $V_{DS} = 0$ )	$V_{GS} = \pm 16\text{ V}$			$\pm 100$	nA
$V_{GS(th)}$	Gate threshold voltage	$V_{DS} = V_{GS}$ , $I_D = 250\ \mu\text{A}$	1		2.5	V
$R_{DS(on)}$	Static drain-source on-resistance	$V_{GS} = 10\text{ V}$ , $I_D = 17.5\text{ A}$ $V_{GS} = 4.5\text{ V}$ , $I_D = 17.5\text{ A}$		0.014 0.016	0.017 0.020	$\Omega$ $\Omega$

**Table 5. Dynamic**

Symbol	Parameter	Test conditions	Min.	Typ.	Max.	Unit
$g_{fs}^{(1)}$	Forward transconductance	$V_{DS} = 15\text{ V}$ , $I_D = 17.5\text{ A}$	-	28		S
$C_{iss}$ $C_{oss}$ $C_{rss}$	Input capacitance Output capacitance Reverse transfer capacitance	$V_{DS} = 25\text{ V}$ , $f = 1\text{ MHz}$ , $V_{GS} = 0$	-	1700 305 105		pF pF pF
$t_{d(on)}$ $t_r$ $t_{d(off)}$ $t_f$	Turn-on delay time Rise time Turn-off delay time Fall time	$V_{DD} = 30\text{ V}$ , $I_D = 27.5\text{ A}$ $R_G = 4.7\ \Omega$ , $V_{GS} = 4.5\text{ V}$ (see <a href="#">Figure 13</a> )	-	20 100 40 20		ns ns ns ns
$Q_g$ $Q_{gs}$ $Q_{gd}$	Total gate charge Gate-source charge Gate-drain charge	$V_{DD} = 48\text{ V}$ , $I_D = 55\text{ A}$ , $V_{GS} = 4.5\text{ V}$ , $R_G = 4.7\ \Omega$ (see <a href="#">Figure 14</a> )	-	25 5 10	33	nC nC nC

1. Pulsed: pulse duration = 300  $\mu\text{s}$ , duty cycle 1.5%.

**Table 6. Source drain diode**

Symbol	Parameter	Test conditions	Min.	Typ.	Max.	Unit
$I_{SD}$ $I_{SDM}^{(1)}$	Source-drain current Source-drain current (pulsed)		-		35 140	A A
$V_{SD}^{(2)}$	Forward on voltage	$I_{SD} = 35 \text{ A}$ , $V_{GS} = 0$	-		1.5	V
$t_{rr}$ $Q_{rr}$ $I_{RRM}$	Reverse recovery time Reverse recovery charge Reverse recovery current	$I_{SD} = 35 \text{ A}$ , $di/dt = 100 \text{ A}/\mu\text{s}$ , $V_{DD} = 30 \text{ V}$ , $T_j = 150 \text{ }^\circ\text{C}$ (see <a href="#">Figure 15</a> )	-	80 200 5		ns nC A

1. Pulse width limited by safe operating area.
2. Pulsed: Pulse duration = 300  $\mu\text{s}$ , duty cycle 1.5%

## 2.1 Electrical characteristics (curves)

Figure 2. Safe operating area

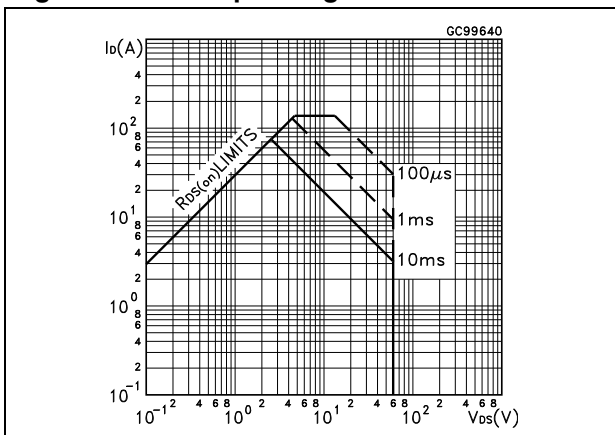

Figure 3. Thermal impedance

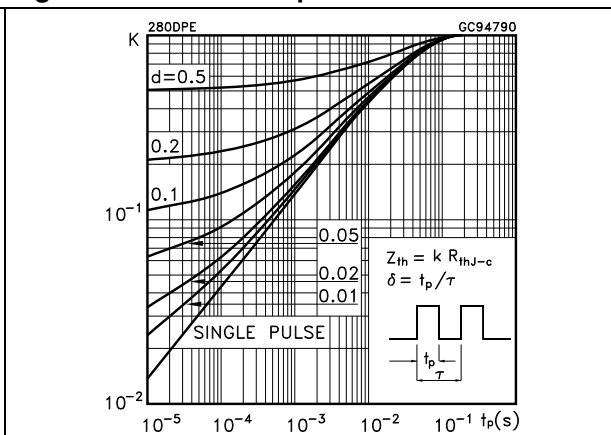

Figure 4. Output characteristics

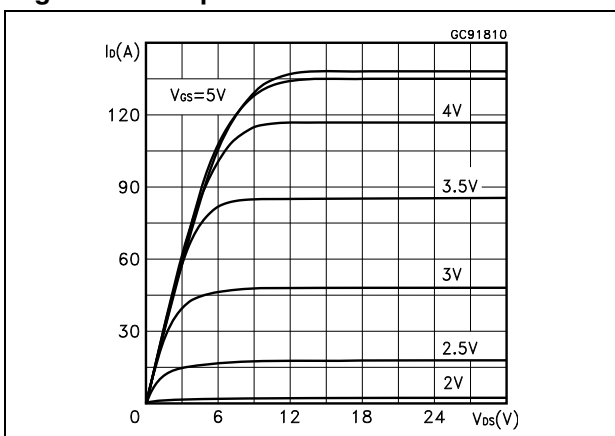

Figure 5. Transfer characteristics

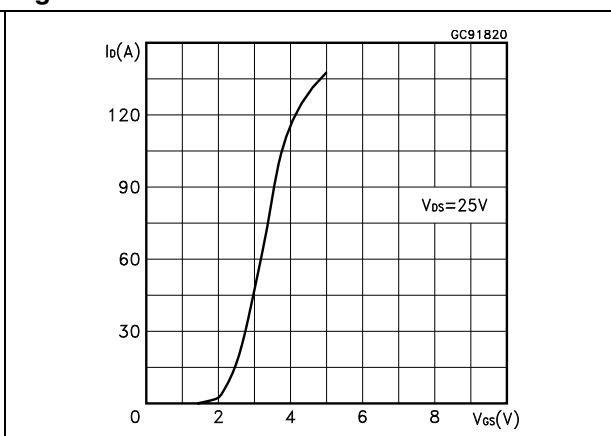

Figure 6. Transconductance

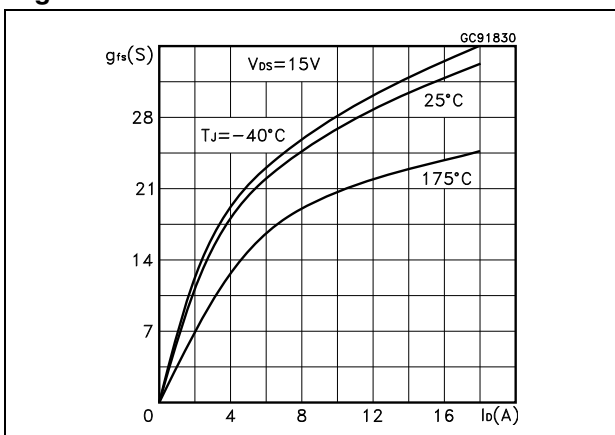

Figure 7. Static drain-source on-resistance

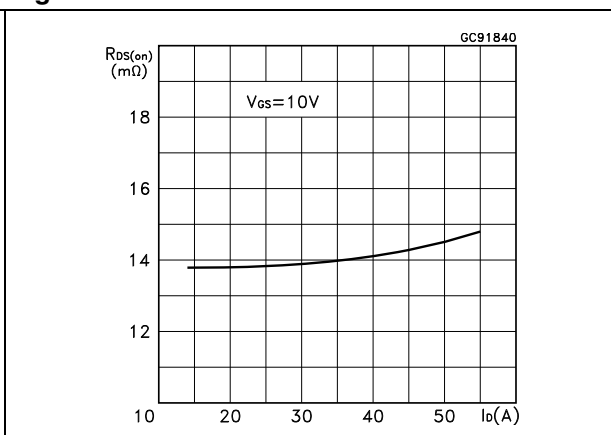

Figure 8. Gate charge vs. gate-source voltage Figure 9. Capacitance variations

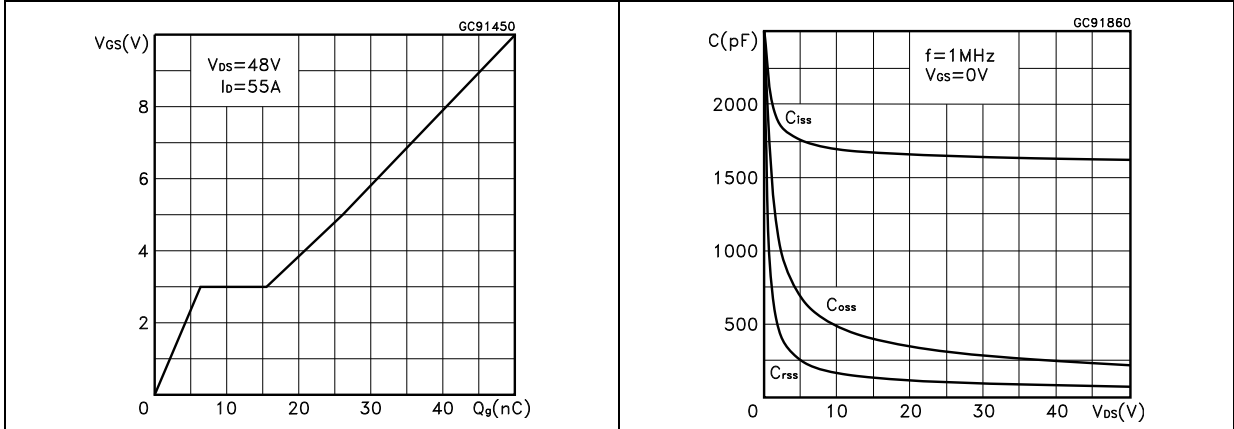

Figure 10. Normalized gate threshold voltage vs. temperature

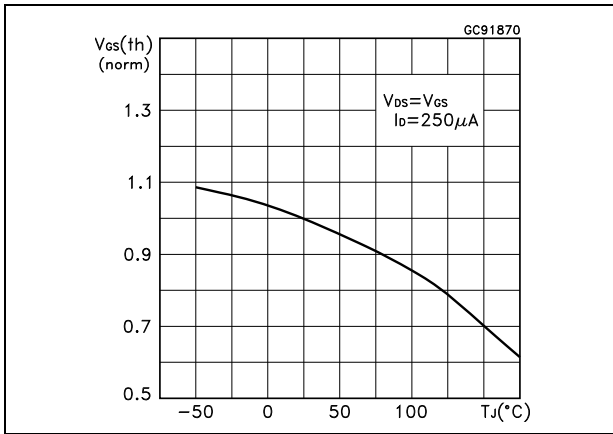

Figure 11. Normalized on-resistance vs. temperature

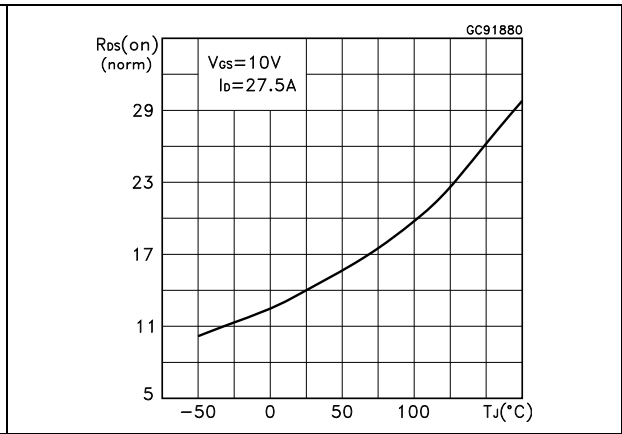
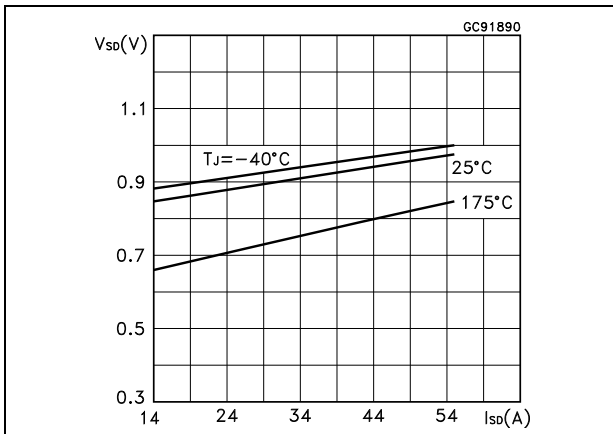

Figure 12. Source-drain diode forward characteristics



### 3 Test circuit

**Figure 13. Switching times test circuit for resistive load**



**Figure 14. Gate charge test circuit**

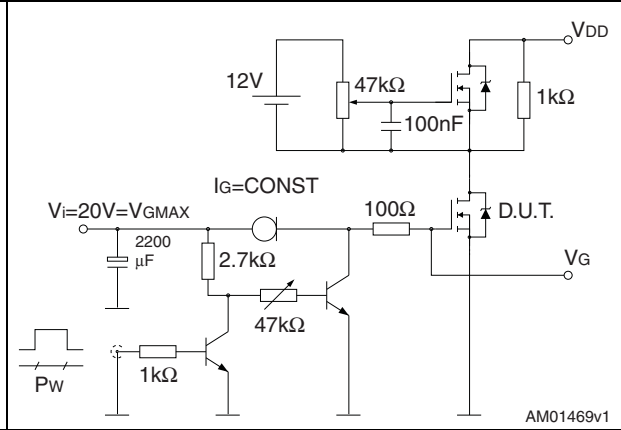

**Figure 15. Test circuit for inductive load switching and diode recovery times**



**Figure 16. Unclamped Inductive load test circuit**



**Figure 17. Unclamped inductive waveform**

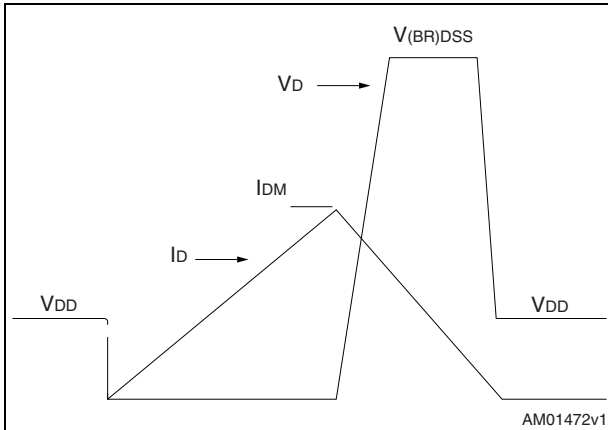

**Figure 18. Switching time waveform**

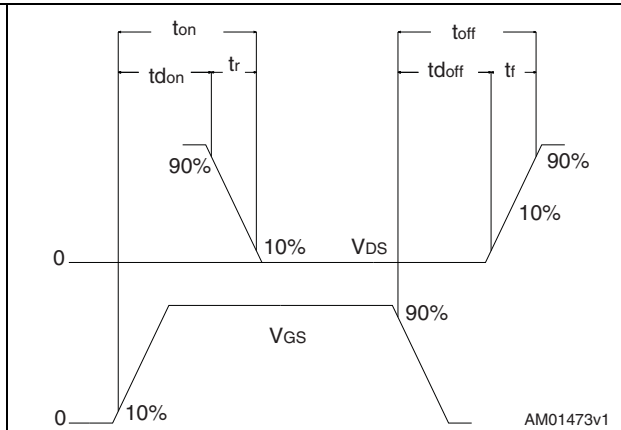



## 4 Package mechanical data

In order to meet environmental requirements, ST offers these devices in different grades of ECOPACK® packages, depending on their level of environmental compliance. ECOPACK® specifications, grade definitions and product status are available at: [www.st.com](http://www.st.com). ECOPACK is an ST trademark.

**Table 7. DPAK (TO-252) mechanical data**

Dim.	mm		
	Min.	Typ.	Max.
A	2.20		2.40
A1	0.90		1.10
A2	0.03		0.23
b	0.64		0.90
b4	5.20		5.40
c	0.45		0.60
c2	0.48		0.60
D	6.00		6.20
D1		5.10	
E	6.40		6.60
E1		4.70	
e		2.28	
e1	4.40		4.60
H	9.35		10.10
L	1		1.50
L1		2.80	
L2		0.80	
L4	0.60		1
R		0.20	
V2	0°		8°

Figure 19. DPAK (TO-252) drawing

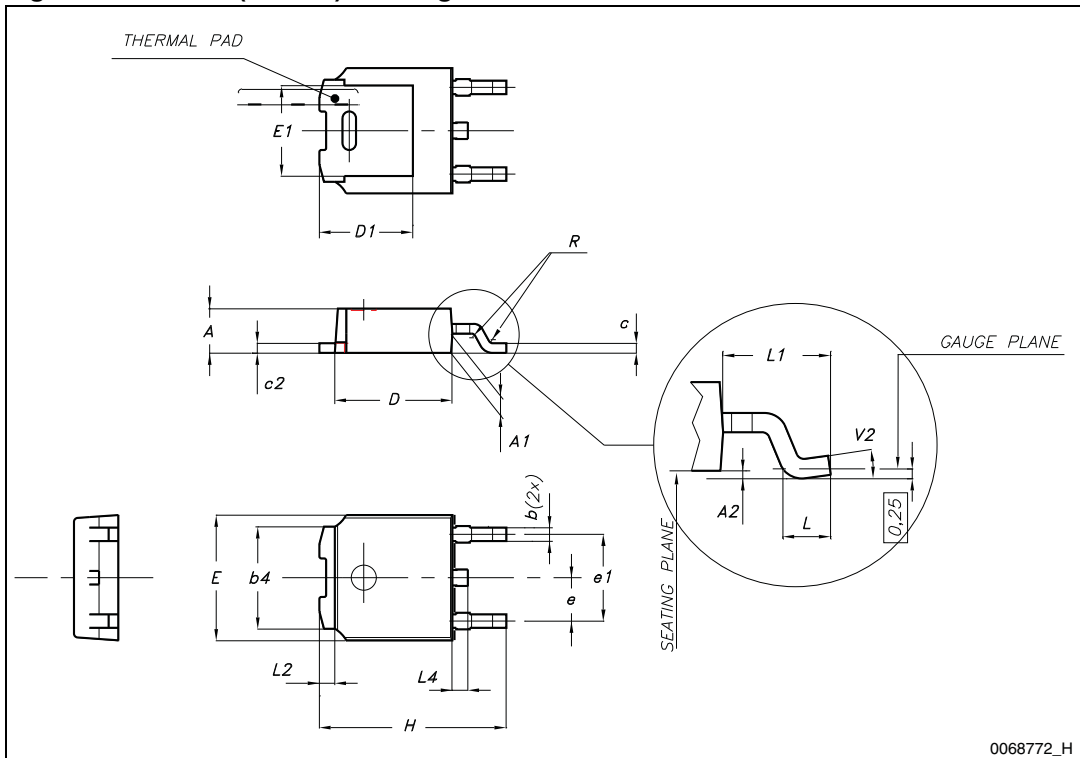
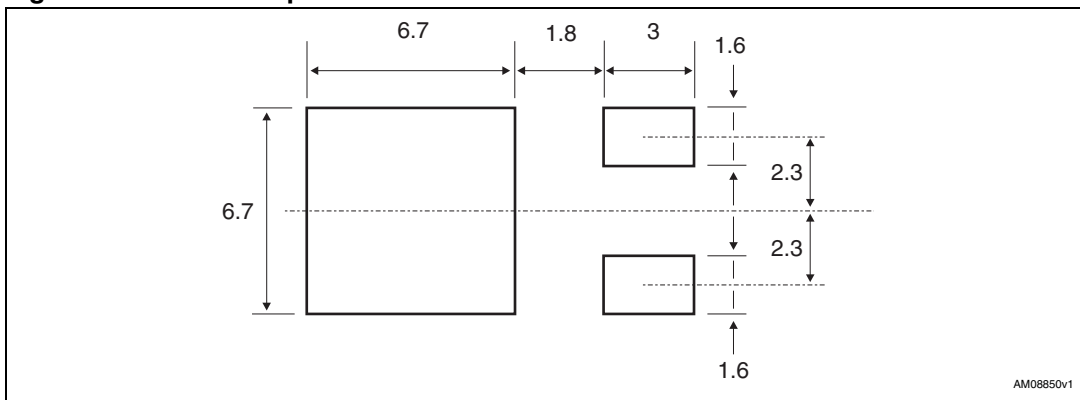

Figure 20. DPAK footprint<sup>(a)</sup>



a. All dimension are in millimeters

## 5 Packing mechanical data

Table 8. DPAK (TO-252) tape and reel mechanical data

Tape			Reel		
Dim.	mm		Dim.	mm	
	Min.	Max.		Min.	Max.
A0	6.8	7	A		330
B0	10.4	10.6	B	1.5	
B1		12.1	C	12.8	13.2
D	1.5	1.6	D	20.2	
D1	1.5		G	16.4	18.4
E	1.65	1.85	N	50	
F	7.4	7.6	T		22.4
K0	2.55	2.75			
P0	3.9	4.1	Base qty.		2500
P1	7.9	8.1	Bulk qty.		2500
P2	1.9	2.1			
R	40				
T	0.25	0.35			
W	15.7	16.3			

Figure 21. Tape for DPAK (TO-252)

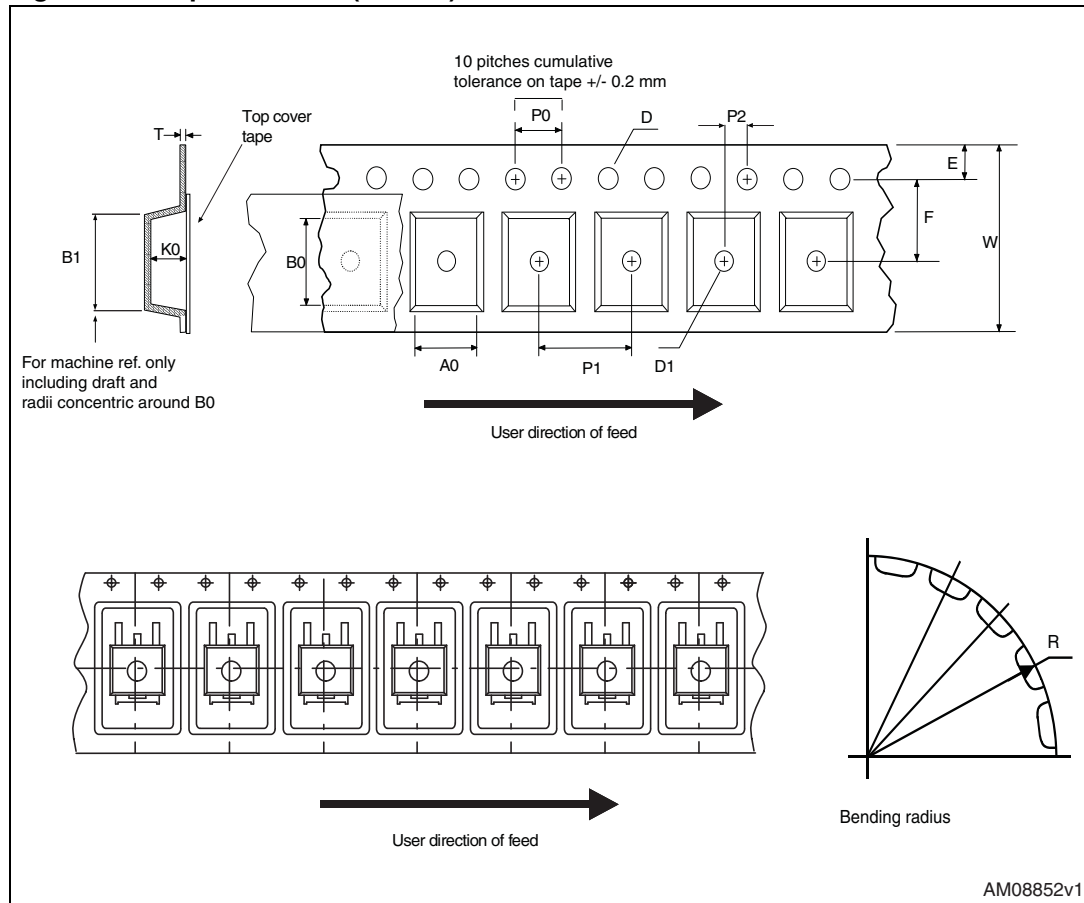
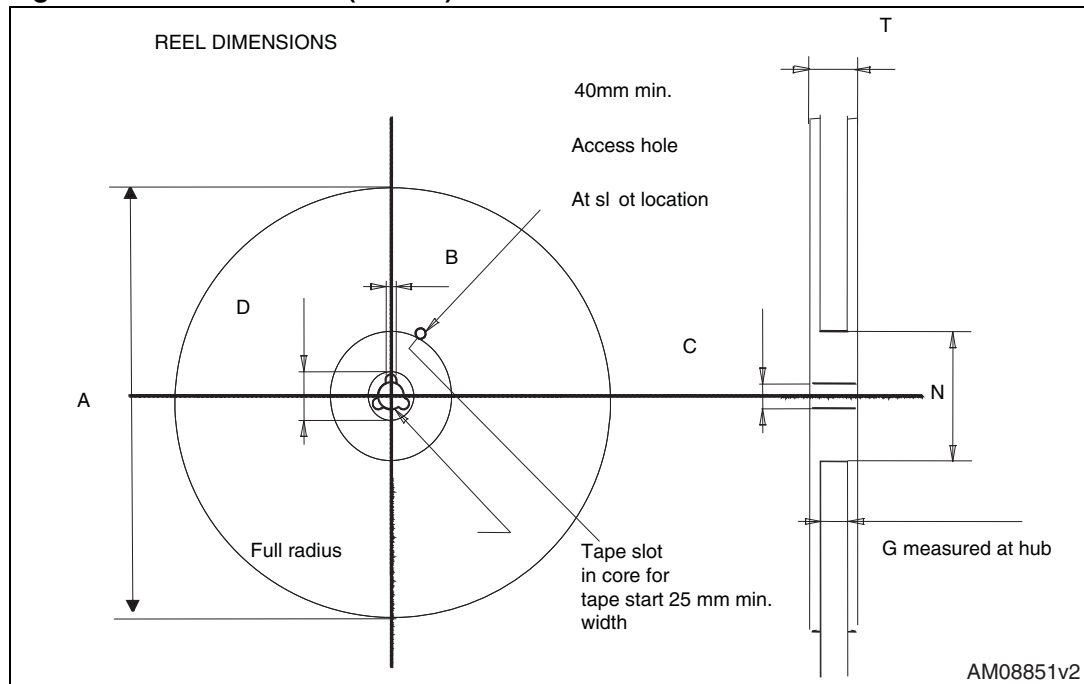

Figure 22. Reel for DPAK (TO-252)



## 6 Revision history

**Table 9. Revision history**

Date	Revision	Changes
21-Jun-2004	2	Preliminary version
06-Jul-2006	3	New template, no content change
20-Feb-2007	4	Typo mistake on page 1
19-Apr-2012	5	Added new value in <a href="#">Table 4: On/off states</a> ( $V_{GS(th)}$ max). Minor text changes.

**Please Read Carefully:**

Information in this document is provided solely in connection with ST products. STMicroelectronics NV and its subsidiaries ("ST") reserve the right to make changes, corrections, modifications or improvements, to this document, and the products and services described herein at any time, without notice.

All ST products are sold pursuant to ST's terms and conditions of sale.

Purchasers are solely responsible for the choice, selection and use of the ST products and services described herein, and ST assumes no liability whatsoever relating to the choice, selection or use of the ST products and services described herein.

No license, express or implied, by estoppel or otherwise, to any intellectual property rights is granted under this document. If any part of this document refers to any third party products or services it shall not be deemed a license grant by ST for the use of such third party products or services, or any intellectual property contained therein or considered as a warranty covering the use in any manner whatsoever of such third party products or services or any intellectual property contained therein.

**UNLESS OTHERWISE SET FORTH IN ST'S TERMS AND CONDITIONS OF SALE ST DISCLAIMS ANY EXPRESS OR IMPLIED WARRANTY WITH RESPECT TO THE USE AND/OR SALE OF ST PRODUCTS INCLUDING WITHOUT LIMITATION IMPLIED WARRANTIES OF MERCHANTABILITY, FITNESS FOR A PARTICULAR PURPOSE (AND THEIR EQUIVALENTS UNDER THE LAWS OF ANY JURISDICTION), OR INFRINGEMENT OF ANY PATENT, COPYRIGHT OR OTHER INTELLECTUAL PROPERTY RIGHT.**

**UNLESS EXPRESSLY APPROVED IN WRITING BY TWO AUTHORIZED ST REPRESENTATIVES, ST PRODUCTS ARE NOT RECOMMENDED, AUTHORIZED OR WARRANTED FOR USE IN MILITARY, AIR CRAFT, SPACE, LIFE SAVING, OR LIFE SUSTAINING APPLICATIONS, NOR IN PRODUCTS OR SYSTEMS WHERE FAILURE OR MALFUNCTION MAY RESULT IN PERSONAL INJURY, DEATH, OR SEVERE PROPERTY OR ENVIRONMENTAL DAMAGE. ST PRODUCTS WHICH ARE NOT SPECIFIED AS "AUTOMOTIVE GRADE" MAY ONLY BE USED IN AUTOMOTIVE APPLICATIONS AT USER'S OWN RISK.**

Resale of ST products with provisions different from the statements and/or technical features set forth in this document shall immediately void any warranty granted by ST for the ST product or service described herein and shall not create or extend in any manner whatsoever, any liability of ST.

ST and the ST logo are trademarks or registered trademarks of ST in various countries.

Information in this document supersedes and replaces all information previously supplied.

The ST logo is a registered trademark of STMicroelectronics. All other names are the property of their respective owners.

© 2012 STMicroelectronics - All rights reserved

STMicroelectronics group of companies

Australia - Belgium - Brazil - Canada - China - Czech Republic - Finland - France - Germany - Hong Kong - India - Israel - Italy - Japan - Malaysia - Malta - Morocco - Philippines - Singapore - Spain - Sweden - Switzerland - United Kingdom - United States of America

[www.st.com](http://www.st.com)

# Mouser Electronics

Authorized Distributor

Click to View Pricing, Inventory, Delivery & Lifecycle Information:

[STMicroelectronics:](#)

[STD35NF06LT4](#)