



STB6N62K3 STD6N62K3

N-channel 620 V, 0.95 Ω , 5.5 A SuperMESH3™ Power MOSFET
in D²PAK, DPAK

Features

| Order codes | V _{DSS} | R _{DS(on)} max. | I _D | P _w |
|------------------------|------------------|-----------------------------|----------------|----------------|
| STB6N62K3 STD6N62K3 | 620 V | < 1.2 Ω | 5.5 A | 90 W |

- 100% avalanche tested
- Extremely high dv/dt capability
- Gate charge minimized
- Very low intrinsic capacitance
- Improved diode reverse recovery characteristics
- Zener-protected

Applications

- Switching applications

Description

These SuperMESH3™ Power MOSFETs are the result of improvements applied to STMicroelectronics' SuperMESH™ technology, combined with a new optimized vertical structure. These devices boast an extremely low on-resistance, superior dynamic performance and high avalanche capability, rendering them suitable for the most demanding applications.

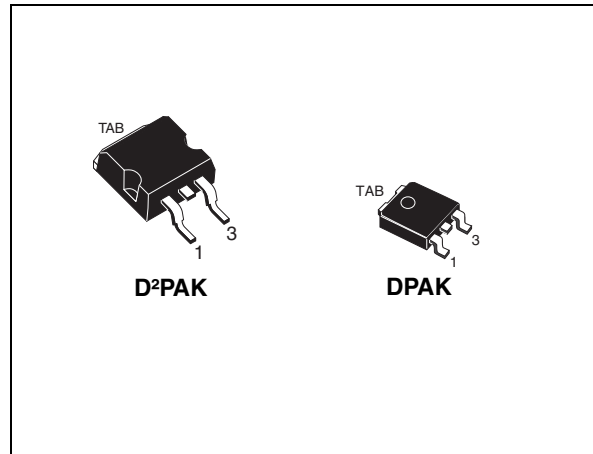

Figure 1. Internal schematic diagram

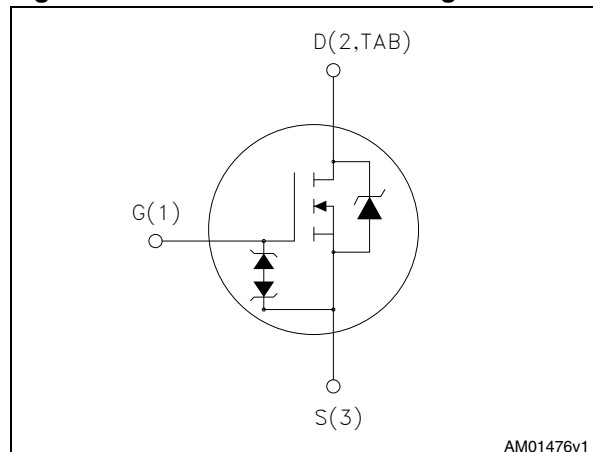

Table 1. Device summary

| Order codes | Marking | Package | Packaging |
|------------------------|---------|----------------------------|---------------|
| STB6N62K3 STD6N62K3 | 6N62K3 | D ² PAK DPAK | Tape and reel |

Contents

| | | |
|----------|---|-----------|
| 1 | Electrical ratings | 3 |
| 2 | Electrical characteristics | 4 |
| 2.1 | Electrical characteristics (curves) | 6 |
| 3 | Test circuits | 9 |
| 4 | Package mechanical data | 10 |
| 5 | Packaging mechanical data | 15 |
| 6 | Revision history | 18 |



1 Electrical ratings

Table 2. Absolute maximum ratings

| Symbol | Parameter | Value | | Unit |
|--------------------------------|---|--------------------|------|------|
| | | D ² PAK | DPAK | |
| V _{DS} | Drain-source voltage | 620 | | V |
| V _{GS} | Gate- source voltage | ± 30 | | V |
| I _D | Drain current (continuous) at T _C = 25 °C | 5.5 | | A |
| I _D | Drain current (continuous) at T _C = 100 °C | 3 | | A |
| I _{DM} ⁽¹⁾ | Drain current (pulsed) | 22 | | A |
| P _{TOT} | Total dissipation at T _C = 25 °C | 90 | | W |
| I _{AR} ⁽²⁾ | Avalanche current, repetitive or not-repetitive | 5.5 | | A |
| E _{AS} ⁽³⁾ | Single pulse avalanche energy | 140 | | mJ |
| ESD | Gate-source human body model (R=1.5 kΩ, C=100 pF) | 2.5 | | kV |
| dv/dt ⁽⁴⁾ | Peak diode recovery voltage slope | 12 | | V/ns |
| T _{stg} | Storage temperature | -55 to 150 | | °C |
| T _j | Max. operating junction temperature | 150 | | °C |

1. Pulse width limited by safe operating area.
2. Pulse width limited by T_j max.
3. Starting T_j = 25 °C, I_D = I_{AR}, V_{DD} = 50 V.
4. I_{SD} ≤ 5.5 A, di/dt ≤ 400 A/μs, V_{DD} = 80% V_{(BR)DSS}.

Table 3. Thermal data

| Symbol | Parameter | D ² PAK | DPAK | Unit |
|-------------------------------------|---------------------------------------|--------------------|------|------|
| R _{thj-case} | Thermal resistance junction-case max. | 1.39 | | °C/W |
| R _{thj-pcb} ⁽¹⁾ | Thermal resistance junction-pcb max. | 30 | 50 | °C/W |

1. When mounted on 1inch² FR-4 board, 2 oz Cu.

2 Electrical characteristics

($T_C = 25\text{ °C}$ unless otherwise specified)

Table 4. On /off states

| Symbol | Parameter | Test conditions | Min. | Typ. | Max. | Unit |
|---------------|--|--|------|------|-----------|--------------------------------|
| $V_{(BR)DSS}$ | Drain-source breakdown voltage | $I_D = 1\text{ mA}$, $V_{GS} = 0$ | 620 | | | V |
| I_{DSS} | Zero gate voltage drain current ($V_{GS} = 0$) | $V_{DS} = 620\text{ V}$ $V_{DS} = 620\text{ V}$, $T_C = 125\text{ °C}$ | | | 0.8 50 | μA μA |
| I_{GSS} | Gate-body leakage current ($V_{DS} = 0$) | $V_{GS} = \pm 20\text{ V}$ | | | ± 9 | μA |
| $V_{GS(th)}$ | Gate threshold voltage | $V_{DS} = V_{GS}$, $I_D = 50\text{ }\mu\text{A}$ | 3 | 3.75 | 4.5 | V |
| $R_{DS(on)}$ | Static drain-source on resistance | $V_{GS} = 10\text{ V}$, $I_D = 2.8\text{ A}$ | | 0.95 | 1.2 | Ω |

Table 5. Dynamic

| Symbol | Parameter | Test conditions | Min. | Typ. | Max. | Unit |
|---------------------|--|--|------|------|------|----------|
| C_{iss} | Input capacitance | $V_{DS} = 50\text{ V}$, $f = 1\text{ MHz}$, $V_{GS} = 0$ | - | 875 | - | pF |
| C_{oss} | Output capacitance | | | 100 | | pF |
| C_{rss} | Reverse transfer capacitance | | | 17 | | pF |
| $C_{oss(er)}^{(1)}$ | Equivalent output capacitance energy related | $V_{GS} = 0$, $V_{DS} = 0\text{ to }480\text{ V}$ | - | 28 | - | pF |
| $C_{oss(tr)}^{(2)}$ | Equivalent output capacitance time related | | | 63 | | pF |
| R_G | Intrinsic gate resistance | $f = 1\text{ MHz}$ open drain | - | 3.5 | - | Ω |
| Q_g | Total gate charge | $V_{DD} = 496\text{ V}$, $I_D = 5.5\text{ A}$, $V_{GS} = 10\text{ V}$ (see Figure 18) | - | 34 | - | nC |
| Q_{gs} | Gate-source charge | | | 4 | | nC |
| Q_{gd} | Gate-drain charge | | | 22 | | nC |

1. Is defined as a constant equivalent capacitance giving the same charging time as C_{oss} when V_{DS} increases from 0 to 80% V_{DSS}

2. Is defined as a constant equivalent capacitance giving the same storage energy as C_{oss} when V_{DS} increases from 0 to 80% V_{DSS}

Table 6. Switching times

| Symbol | Parameter | Test conditions | Min. | Typ. | Max. | Unit |
|--------------|---------------------|---|------|------|------|------|
| $t_{d(on)}$ | Turn-on delay time | $V_{DD} = 310\text{ V}$, $I_D = 2.75\text{ A}$, $R_G = 4.7\ \Omega$, $V_{GS} = 10\text{ V}$ (see Figure 17) | - | 22 | - | ns |
| t_r | Rise time | | | 12 | | ns |
| $t_{d(off)}$ | Turn-off-delay time | | | 49 | | ns |
| t_f | Fall time | | | 20 | | ns |

Table 7. Source drain diode

| Symbol | Parameter | Test conditions | Min. | Typ. | Max. | Unit |
|-----------------|-------------------------------|--|------|------|------|------|
| I_{SD} | Source-drain current | | - | | 5.5 | A |
| $I_{SDM}^{(1)}$ | Source-drain current (pulsed) | | | | 27 | A |
| $V_{SD}^{(2)}$ | Forward on voltage | $I_{SD} = 5.5\text{ A}$, $V_{GS} = 0$ | - | | 1.5 | V |
| t_{rr} | Reverse recovery time | $I_{SD} = 5.5\text{ A}$, $di/dt = 100\text{ A}/\mu\text{s}$ $V_{DD} = 60\text{ V}$ (see Figure 22) | - | 290 | | ns |
| Q_{rr} | Reverse recovery charge | | | 1900 | | nC |
| I_{RRM} | Reverse recovery current | | | 13.5 | | A |
| t_{rr} | Reverse recovery time | $I_{SD} = 5.5\text{ A}$, $di/dt = 100\text{ A}/\mu\text{s}$ $V_{DD} = 60\text{ V}$, $T_j = 150\text{ }^\circ\text{C}$ (see Figure 22) | - | 335 | | ns |
| Q_{rr} | Reverse recovery charge | | | 2400 | | nC |
| I_{RRM} | Reverse recovery current | | | 14.5 | | A |

1. Pulse width limited by safe operating area

2. Pulsed: pulse duration = 300 μs , duty cycle 1.5%

Table 8. Gate-source Zener diode

| Symbol | Parameter | Test conditions | Min. | Typ. | Max. | Unit |
|---------------|---|----------------------------|------|------|------|------|
| $V_{(BR)GSO}$ | Gate-source breakdown voltage ($I_D = 0$) | $I_{GS} = \pm 1\text{ mA}$ | 30 | - | | V |

The built-in back-to-back Zener diodes have specifically been designed to enhance not only the device's ESD capability, but also to make them safely absorb possible voltage transients that may occasionally be applied from gate to source. In this respect the Zener voltage is appropriate to achieve an efficient and cost-effective intervention to protect the device's integrity. These integrated Zener diodes thus avoid the usage of external components.

2.1 Electrical characteristics (curves)

Figure 2. Safe operating area for D²PAK

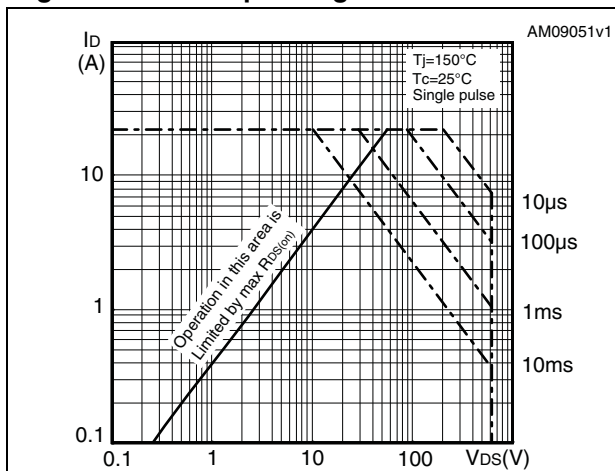

Figure 3. Thermal impedance for D²PAK

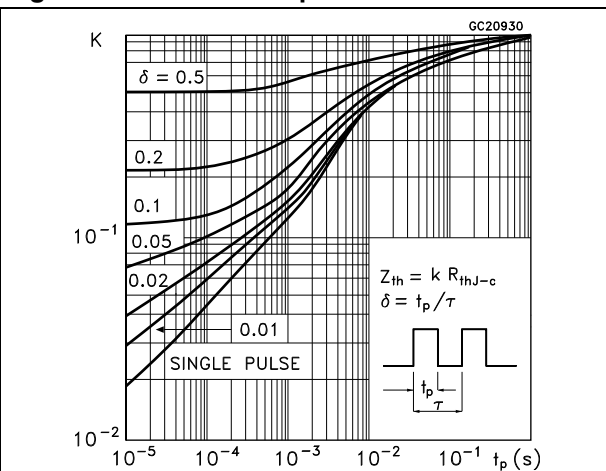

Figure 4. Safe operating area for DPAK

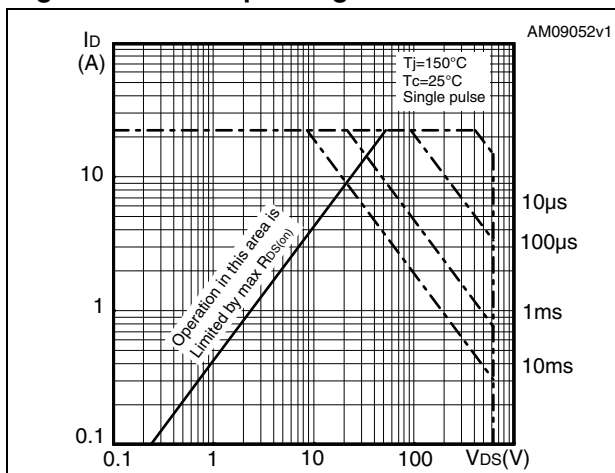

Figure 5. Thermal impedance for DPAK

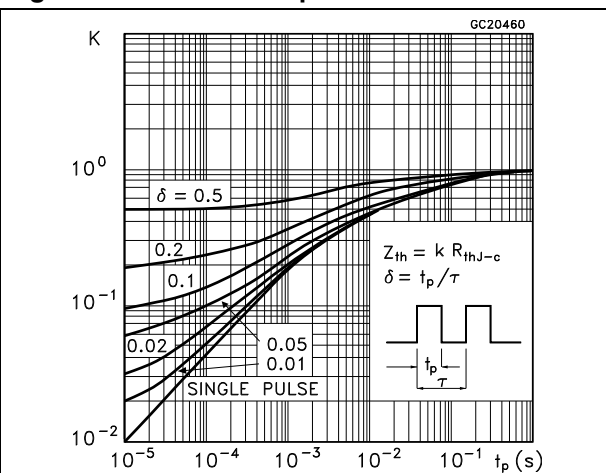

Figure 6. Output characteristics

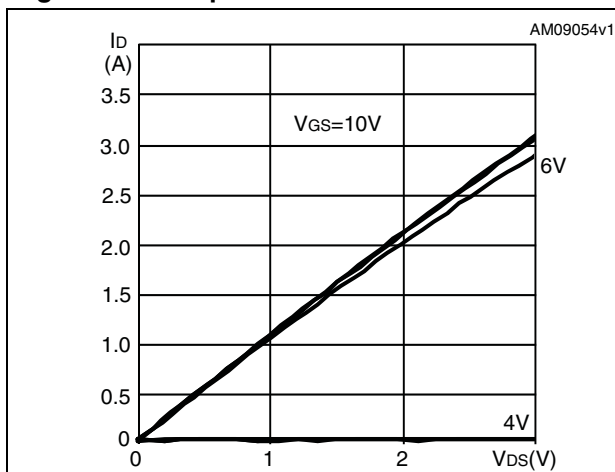

Figure 7. Transfer characteristics

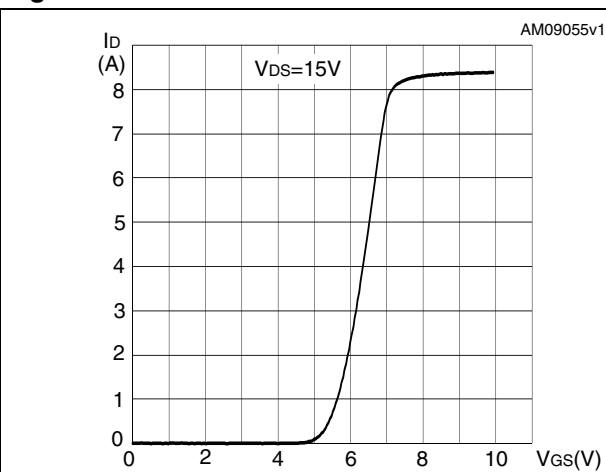

Figure 8. Gate charge vs gate-source voltage Figure 9. Static drain-source on resistance

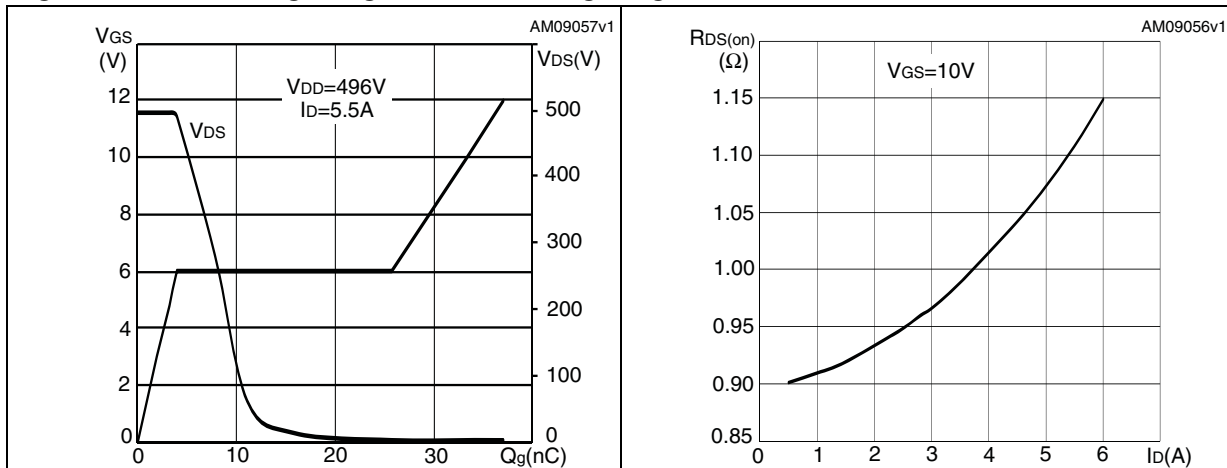

Figure 10. Capacitance variations Figure 11. Output capacitance stored energy

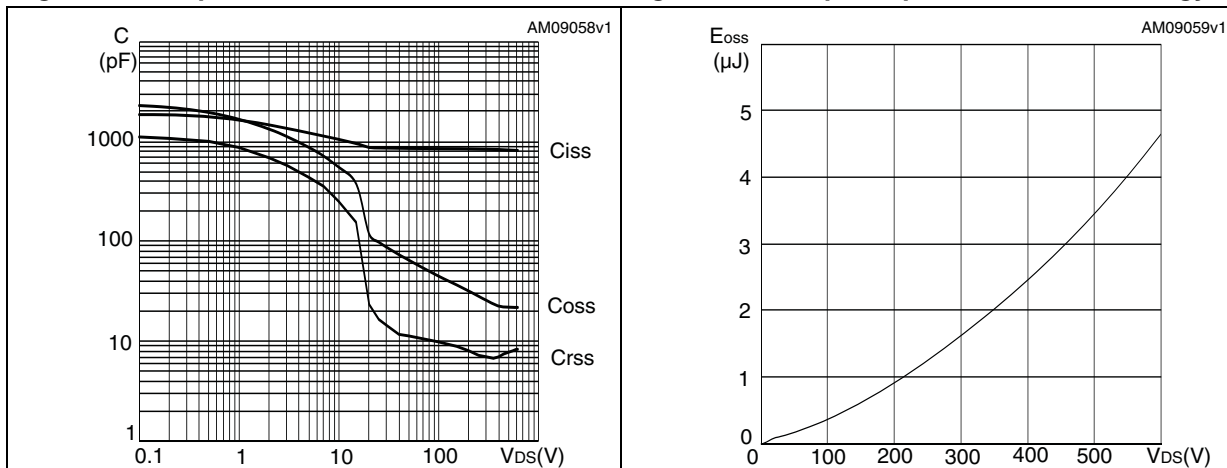

Figure 12. Normalized gate threshold voltage vs temperature Figure 13. Normalized on resistance vs temperature

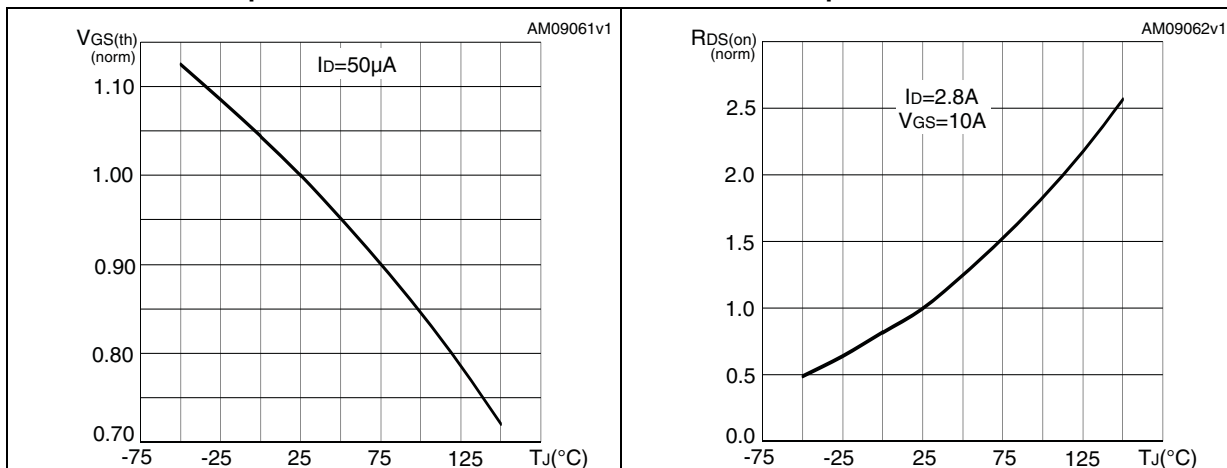

Figure 14. Normalized B_{VDSS} vs temperature

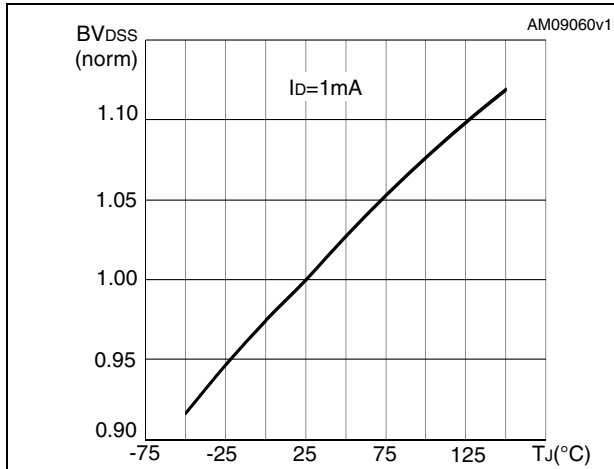

Figure 15. Source-drain diode forward characteristics

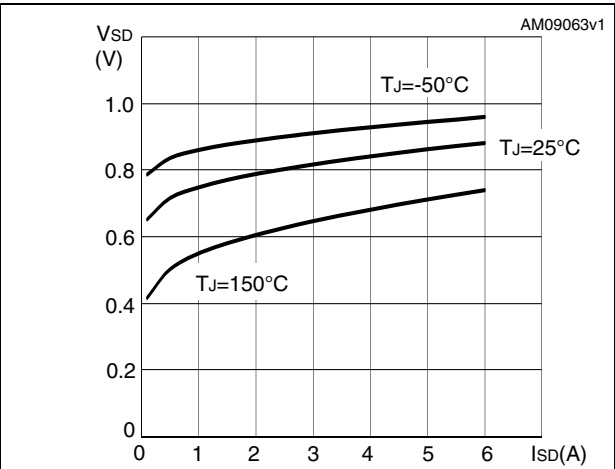
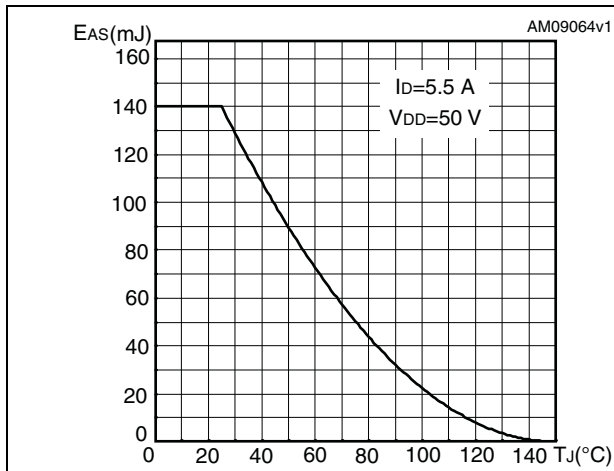

Figure 16. Maximum avalanche energy vs temperature



3 Test circuits

Figure 17. Switching times test circuit for resistive load



AM01468v1

Figure 18. Gate charge test circuit



AM01469v1

Figure 19. Test circuit for inductive load switching and diode recovery times



AM01470v1

Figure 20. Unclamped Inductive load test circuit



AM01471v1

Figure 21. Unclamped inductive waveform



AM01472v1

Figure 22. Switching time waveform



AM01473v1

4 Package mechanical data

In order to meet environmental requirements, ST offers these devices in different grades of ECOPACK® packages, depending on their level of environmental compliance. ECOPACK® specifications, grade definitions and product status are available at: www.st.com. ECOPACK is an ST trademark.

Table 9. D²PAK (TO-263) mechanical data

| Dim. | mm | | |
|------|------|------|-------|
| | Min. | Typ. | Max. |
| A | 4.40 | | 4.60 |
| A1 | 0.03 | | 0.23 |
| b | 0.70 | | 0.93 |
| b2 | 1.14 | | 1.70 |
| c | 0.45 | | 0.60 |
| c2 | 1.23 | | 1.36 |
| D | 8.95 | | 9.35 |
| D1 | 7.50 | | |
| E | 10 | | 10.40 |
| E1 | 8.50 | | |
| e | | 2.54 | |
| e1 | 4.88 | | 5.28 |
| H | 15 | | 15.85 |
| J1 | 2.49 | | 2.69 |
| L | 2.29 | | 2.79 |
| L1 | 1.27 | | 1.40 |
| L2 | 1.30 | | 1.75 |
| R | | 0.4 | |
| V2 | 0° | | 8° |

Figure 23. D²PAK (TO-263) drawing

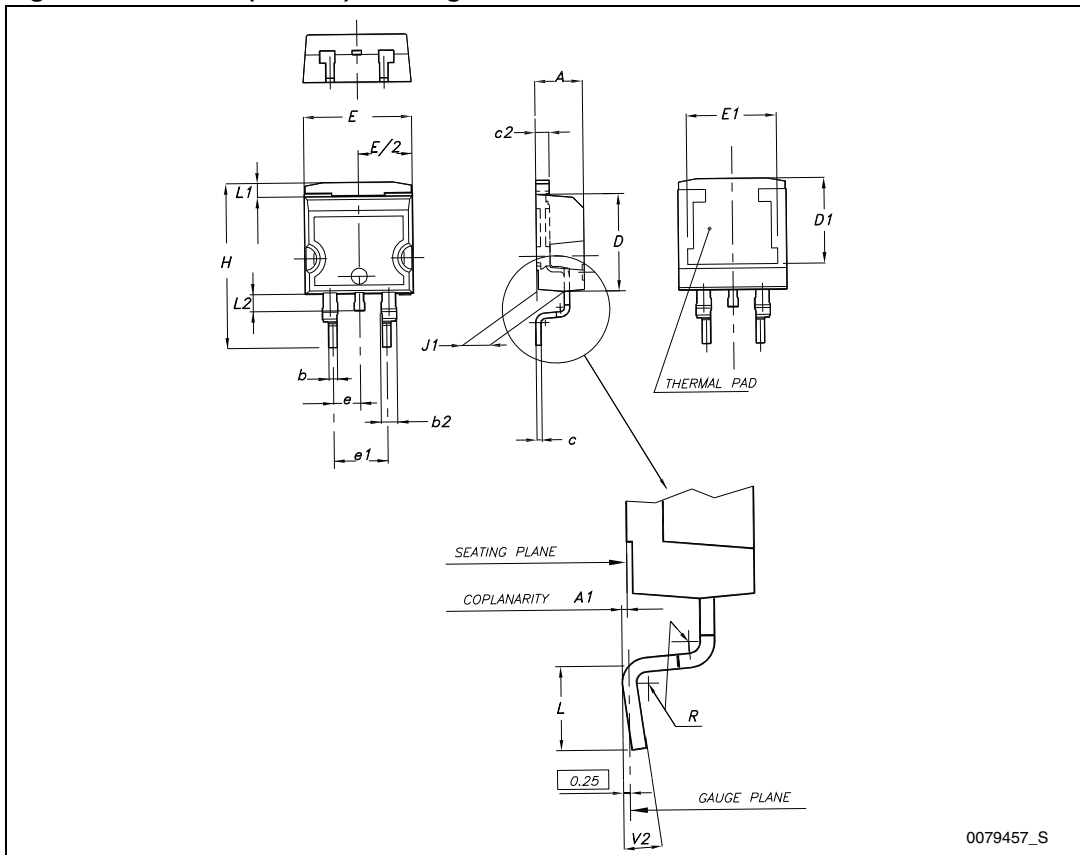
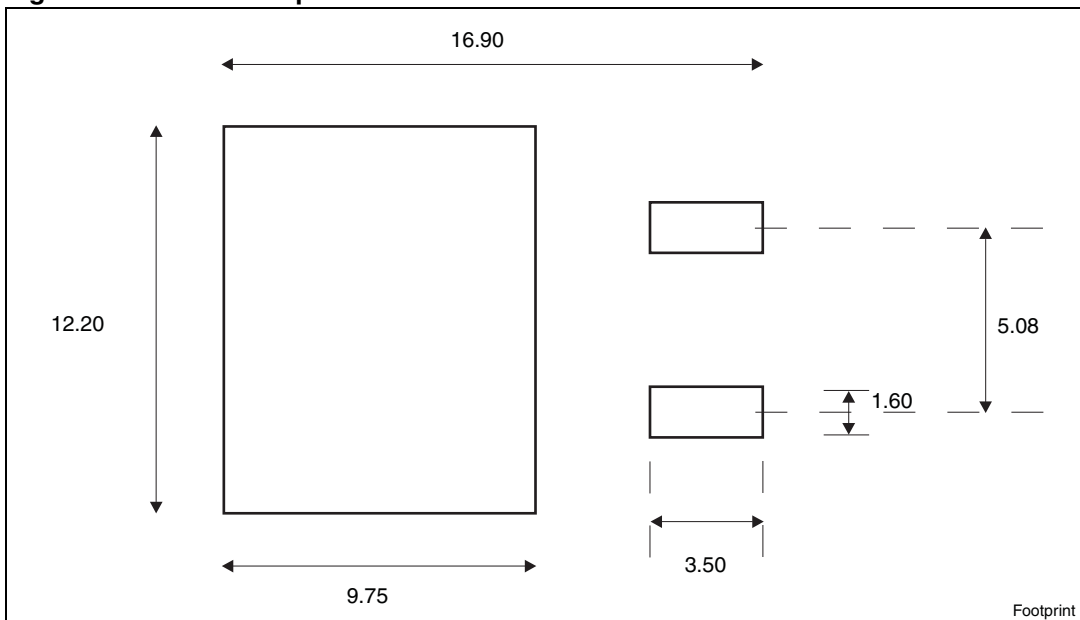

Figure 24. D²PAK footprint^(a)



a. All dimensions are in millimeters

Table 10. DPAK (TO-252) mechanical data

| Dim. | mm | | |
|------|------|------|-------|
| | Min. | Typ. | Max. |
| A | 2.20 | | 2.40 |
| A1 | 0.90 | | 1.10 |
| A2 | 0.03 | | 0.23 |
| b | 0.64 | | 0.90 |
| b4 | 5.20 | | 5.40 |
| c | 0.45 | | 0.60 |
| c2 | 0.48 | | 0.60 |
| D | 6.00 | | 6.20 |
| D1 | | 5.10 | |
| E | 6.40 | | 6.60 |
| E1 | | 4.70 | |
| e | | 2.28 | |
| e1 | 4.40 | | 4.60 |
| H | 9.35 | | 10.10 |
| L | 1 | | 1.50 |
| L1 | | 2.80 | |
| L2 | | 0.80 | |
| L4 | 0.60 | | 1 |
| R | | 0.20 | |
| V2 | 0° | | 8° |

Figure 25. DPAK (TO-252) drawing

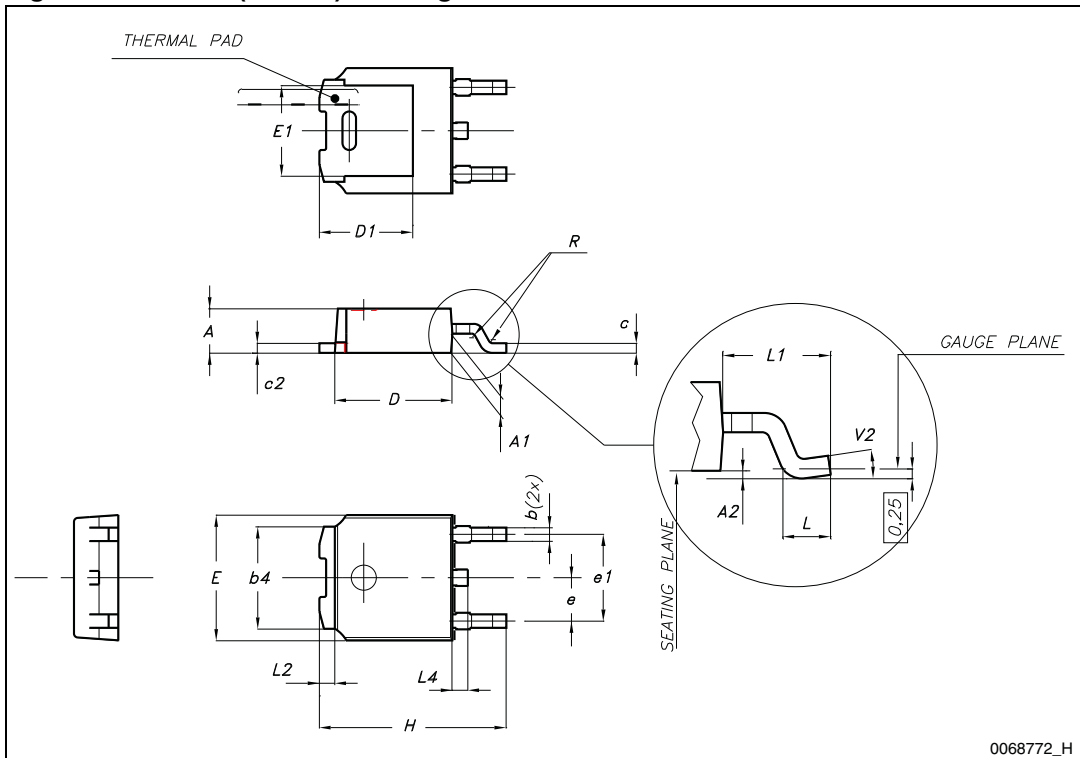
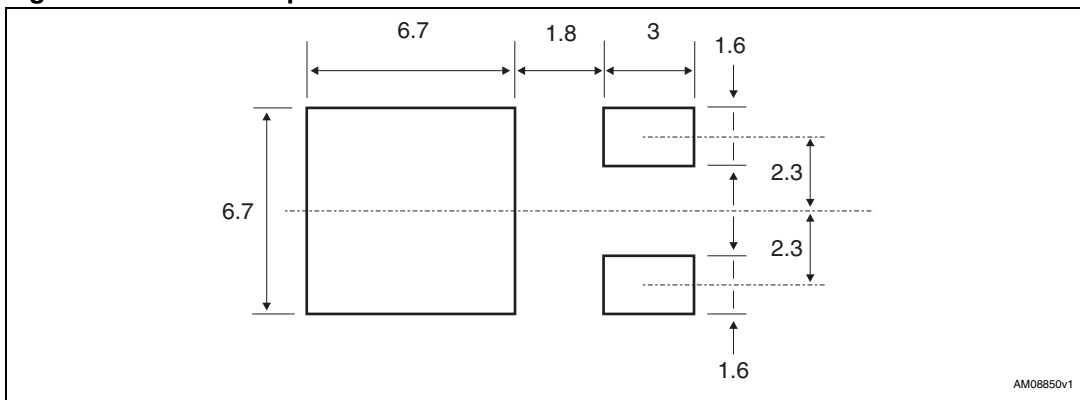

Figure 26. DPAK footprint^(b)



b. All dimensions are in millimeters

5 Packaging mechanical data

Table 11. D²PAK (TO-263) tape and reel mechanical data

| Tape | | | Reel | | |
|------|------|------|----------|------|------|
| Dim. | mm | | Dim. | mm | |
| | Min. | Max. | | Min. | Max. |
| A0 | 10.5 | 10.7 | A | | 330 |
| B0 | 15.7 | 15.9 | B | 1.5 | |
| D | 1.5 | 1.6 | C | 12.8 | 13.2 |
| D1 | 1.59 | 1.61 | D | 20.2 | |
| E | 1.65 | 1.85 | G | 24.4 | 26.4 |
| F | 11.4 | 11.6 | N | 100 | |
| K0 | 4.8 | 5.0 | T | | 30.4 |
| P0 | 3.9 | 4.1 | | | |
| P1 | 11.9 | 12.1 | Base qty | | 1000 |
| P2 | 1.9 | 2.1 | Bulk qty | | 1000 |
| R | 50 | | | | |
| T | 0.25 | 0.35 | | | |
| W | 23.7 | 24.3 | | | |

Table 12. DPAK (TO-252) tape and reel mechanical data

| Tape | | | Reel | | |
|------|------|------|-----------|------|------|
| Dim. | mm | | Dim. | mm | |
| | Min. | Max. | | Min. | Max. |
| A0 | 6.8 | 7 | A | | 330 |
| B0 | 10.4 | 10.6 | B | 1.5 | |
| B1 | | 12.1 | C | 12.8 | 13.2 |
| D | 1.5 | 1.6 | D | 20.2 | |
| D1 | 1.5 | | G | 16.4 | 18.4 |
| E | 1.65 | 1.85 | N | 50 | |
| F | 7.4 | 7.6 | T | | 22.4 |
| K0 | 2.55 | 2.75 | | | |
| P0 | 3.9 | 4.1 | Base qty. | | 2500 |
| P1 | 7.9 | 8.1 | Bulk qty. | | 2500 |
| P2 | 1.9 | 2.1 | | | |
| R | 40 | | | | |
| T | 0.25 | 0.35 | | | |
| W | 15.7 | 16.3 | | | |

Figure 27. Tape for DPAK (TO-252) and D²PAK (TO-263)

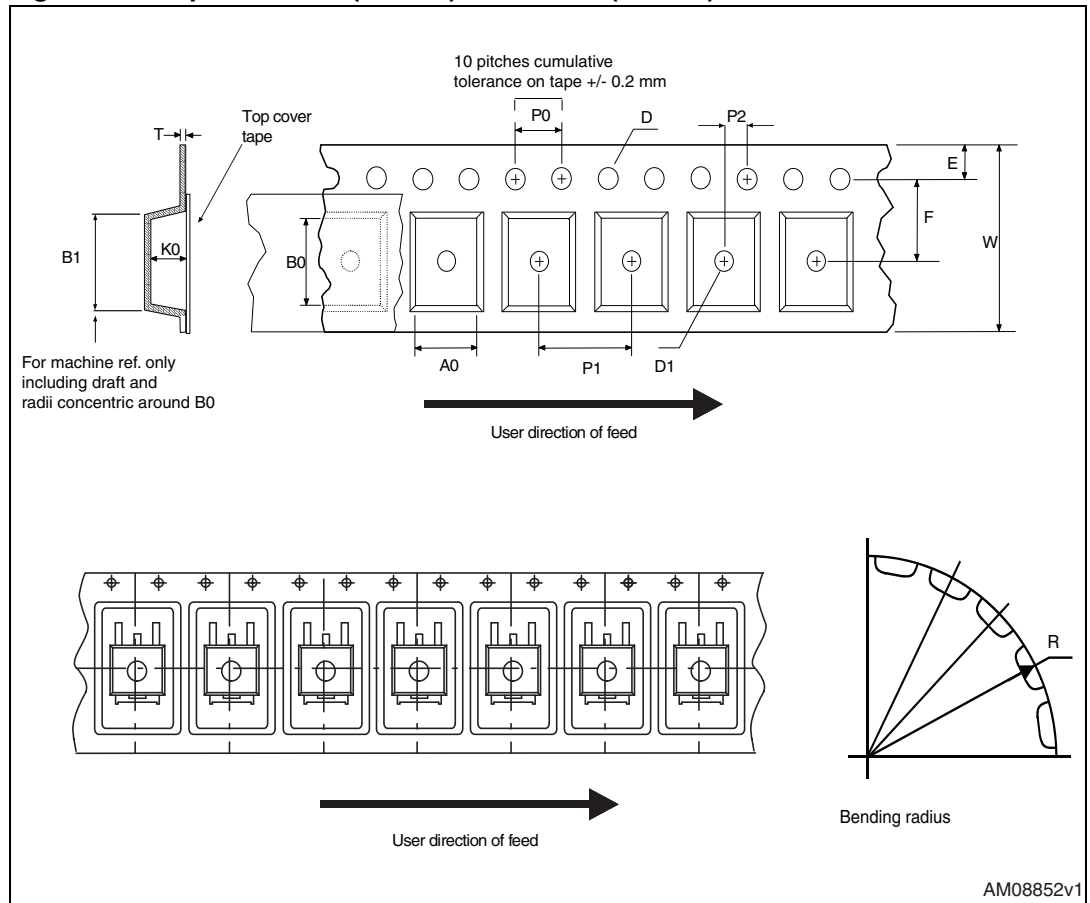
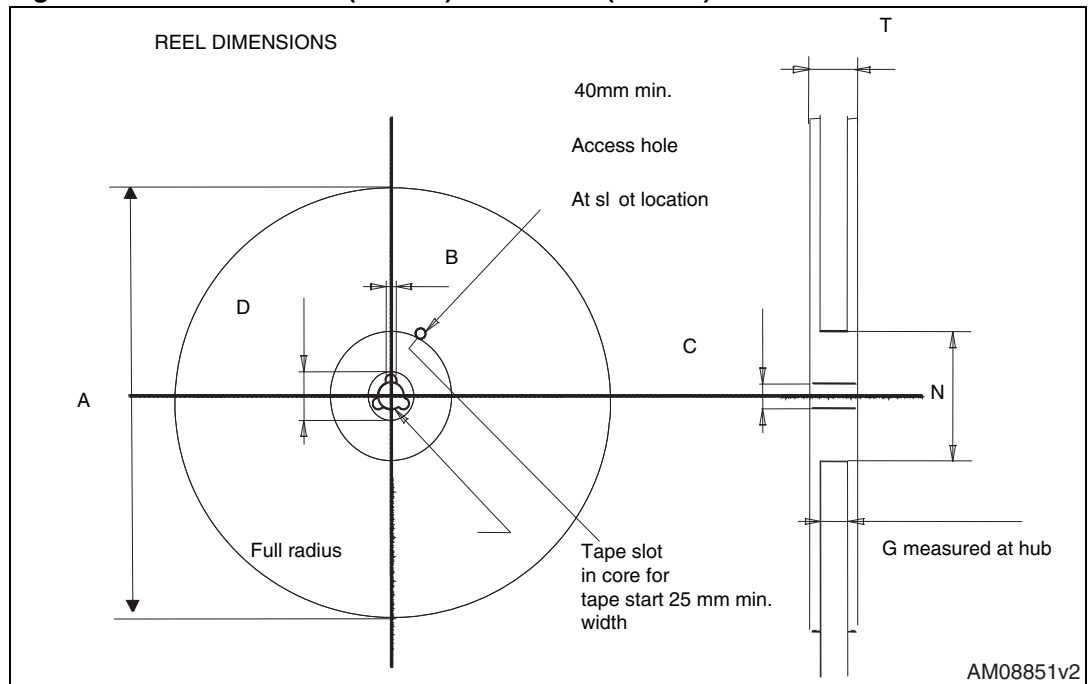

Figure 28. Reel for DPAK (TO-252) and D²PAK (TO-263)



6 Revision history

Table 13. Document revision history

| Date | Revision | Changes |
|-------------|----------|----------------|
| 21-Dec-2011 | 1 | First release. |

Please Read Carefully:

Information in this document is provided solely in connection with ST products. STMicroelectronics NV and its subsidiaries ("ST") reserve the right to make changes, corrections, modifications or improvements, to this document, and the products and services described herein at any time, without notice.

All ST products are sold pursuant to ST's terms and conditions of sale.

Purchasers are solely responsible for the choice, selection and use of the ST products and services described herein, and ST assumes no liability whatsoever relating to the choice, selection or use of the ST products and services described herein.

No license, express or implied, by estoppel or otherwise, to any intellectual property rights is granted under this document. If any part of this document refers to any third party products or services it shall not be deemed a license grant by ST for the use of such third party products or services, or any intellectual property contained therein or considered as a warranty covering the use in any manner whatsoever of such third party products or services or any intellectual property contained therein.

UNLESS OTHERWISE SET FORTH IN ST'S TERMS AND CONDITIONS OF SALE ST DISCLAIMS ANY EXPRESS OR IMPLIED WARRANTY WITH RESPECT TO THE USE AND/OR SALE OF ST PRODUCTS INCLUDING WITHOUT LIMITATION IMPLIED WARRANTIES OF MERCHANTABILITY, FITNESS FOR A PARTICULAR PURPOSE (AND THEIR EQUIVALENTS UNDER THE LAWS OF ANY JURISDICTION), OR INFRINGEMENT OF ANY PATENT, COPYRIGHT OR OTHER INTELLECTUAL PROPERTY RIGHT.

UNLESS EXPRESSLY APPROVED IN WRITING BY TWO AUTHORIZED ST REPRESENTATIVES, ST PRODUCTS ARE NOT RECOMMENDED, AUTHORIZED OR WARRANTED FOR USE IN MILITARY, AIR CRAFT, SPACE, LIFE SAVING, OR LIFE SUSTAINING APPLICATIONS, NOR IN PRODUCTS OR SYSTEMS WHERE FAILURE OR MALFUNCTION MAY RESULT IN PERSONAL INJURY, DEATH, OR SEVERE PROPERTY OR ENVIRONMENTAL DAMAGE. ST PRODUCTS WHICH ARE NOT SPECIFIED AS "AUTOMOTIVE GRADE" MAY ONLY BE USED IN AUTOMOTIVE APPLICATIONS AT USER'S OWN RISK.

Resale of ST products with provisions different from the statements and/or technical features set forth in this document shall immediately void any warranty granted by ST for the ST product or service described herein and shall not create or extend in any manner whatsoever, any liability of ST.

ST and the ST logo are trademarks or registered trademarks of ST in various countries.

Information in this document supersedes and replaces all information previously supplied.

The ST logo is a registered trademark of STMicroelectronics. All other names are the property of their respective owners.

© 2011 STMicroelectronics - All rights reserved

STMicroelectronics group of companies

Australia - Belgium - Brazil - Canada - China - Czech Republic - Finland - France - Germany - Hong Kong - India - Israel - Italy - Japan - Malaysia - Malta - Morocco - Philippines - Singapore - Spain - Sweden - Switzerland - United Kingdom - United States of America

www.st.com



Mouser Electronics

Authorized Distributor

Click to View Pricing, Inventory, Delivery & Lifecycle Information:

[STMicroelectronics:](#)

[STD6N62K3](#)