

## N-channel 60 V, 4.6 mΩ typ., 46 A STripFET™ F7 Power MOSFET in a TO-220FP package

Datasheet - production data

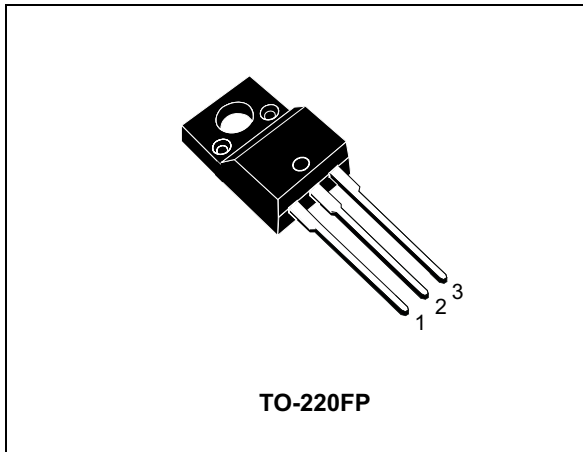
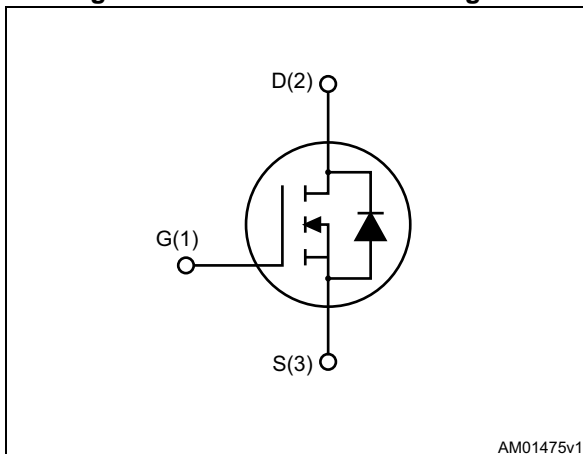

Figure 1. Internal schematic diagram



### Features

Order code	V <sub>DS</sub>	R <sub>DS(on)</sub> max.	I <sub>D</sub>	P <sub>TOT</sub>
STF100N6F7	60 V	5.6 mΩ	46 A	25 W

- Among the lowest R<sub>DS(on)</sub> on the market
- Excellent figure of merit (FoM)
- Low C<sub>rss</sub>/C<sub>iss</sub> ratio for EMI immunity
- High avalanche ruggedness

### Applications

- Switching applications

### Description

This N-channel Power MOSFET utilizes STripFET™ F7 technology with an enhanced trench gate structure that results in very low on-state resistance, while also reducing internal capacitance and gate charge for faster and more efficient switching.

Table 1. Device summary

Order code	Marking	Package	Packaging
STF100N6F7	100N6F7	TO-220FP	Tube

# Contents

<b>1</b>	<b>Electrical ratings</b> .....	<b>3</b>
<b>2</b>	<b>Electrical characteristics</b> .....	<b>4</b>
	2.1 Electrical characteristics (curves) .....	6
<b>3</b>	<b>Test circuits</b> .....	<b>8</b>
<b>4</b>	<b>Package mechanical data</b> .....	<b>9</b>
<b>5</b>	<b>Revision history</b> .....	<b>12</b>

# 1 Electrical ratings

**Table 2. Absolute maximum ratings**

Symbol	Parameter	Value	Unit
$V_{DS}$	Drain-source voltage	60	V
$V_{GS}$	Gate-source voltage	$\pm 20$	V
$I_D$	Drain current (continuous) at $T_C = 25\text{ }^\circ\text{C}$	46 <sup>(1)</sup>	A
$I_D$	Drain current (continuous) at $T_C = 100\text{ }^\circ\text{C}$	33 <sup>(1)</sup>	A
$I_{DM}^{(2)}$	Drain current (pulsed)	184	A
$P_{TOT}$	Total dissipation at $T_C = 25\text{ }^\circ\text{C}$	25	W
$E_{AS}^{(3)}$	Single pulse avalanche energy	200	mJ
$dV/dt^{(4)}$	Drain-body diode dynamic $dV/dt$ ruggedness	6	V/ns
$V_{ISO}$	Insulation withstand voltage (RMS) from all three leads to external heat sink ( $t = 1\text{ s}$ ; $T_C = 25\text{ }^\circ\text{C}$ )	2500	V
$T_j$	Operating junction temperature	-55 to 175	$^\circ\text{C}$
$T_{stg}$	Storage temperature		

- Limited by package
- Pulse width is limited by safe operating area
- Starting  $T_j = 25\text{ }^\circ\text{C}$ ,  $I_D = 20\text{ A}$ ,  $V_{DD} = 30\text{ V}$
- $I_{SD} = 46\text{ A}$ ;  $di/dt = 600\text{ A}/\mu\text{s}$ ;  $V_{DD} = 48\text{ V}$ ;  $T_j < T_{jmax}$

**Table 3. Thermal data**

Symbol	Parameter	Value	Unit
$R_{thj-case}$	Thermal resistance junction-case	6	$^\circ\text{C}/\text{W}$
$R_{thj-amb}$	Thermal resistance junction-ambient	62.5	$^\circ\text{C}/\text{W}$

## 2 Electrical characteristics

( $T_{CASE} = 25\text{ °C}$  unless otherwise specified)

**Table 4. On/off states**

Symbol	Parameter	Test conditions	Min.	Typ.	Max.	Unit
$V_{(BR)DSS}$	Drain-source breakdown voltage	$V_{GS} = 0\text{ V}, I_D = 1\text{ mA}$	60			V
$I_{DSS}$	Zero gate voltage Drain current	$V_{GS} = 0\text{ V}, V_{DS} = 60\text{ V}$			1	$\mu\text{A}$
		$V_{GS} = 0\text{ V}, V_{DS} = 60\text{ V}, T_J = 125\text{ °C}$			100	$\mu\text{A}$
$I_{GSS}$	Gate-source leakage current	$V_{DS} = 0\text{ V}, V_{GS} = 20\text{ V}$			100	nA
$V_{GS(th)}$	Gate threshold voltage	$V_{DS} = V_{GS}, I_D = 250\text{ }\mu\text{A}$	2		4	V
$R_{DS(on)}$	Static drain-source on-resistance	$V_{GS} = 10\text{ V}, I_D = 23\text{ A}$		4.6	5.6	m $\Omega$

**Table 5. Dynamic**

Symbol	Parameter	Test conditions	Min.	Typ.	Max.	Unit
$C_{iss}$	Input capacitance	$V_{GS} = 0\text{ V}, V_{DS} = 25\text{ V}, f = 1\text{ MHz}$	-	1980	-	pF
$C_{oss}$	Output capacitance		-	970	-	pF
$C_{rss}$	Reverse transfer capacitance		-	86	-	pF
$Q_g$	Total gate charge	$V_{DD} = 30\text{ V}, I_D = 46\text{ A}, V_{GS} = 10\text{ V}$	-	30	-	nC
$Q_{gs}$	Gate-source charge		-	12.6	-	nC
$Q_{gd}$	Gate-drain charge		-	5.9	-	nC

**Table 6. Switching times**

Symbol	Parameter	Test conditions	Min.	Typ.	Max.	Unit
$t_{d(on)}$	Turn-on delay time	$V_{DD} = 30\text{ V}, I_D = 23\text{ A}, R_G = 4.7\text{ }\Omega, V_{GS} = 10\text{ V}$	-	21.6	-	ns
$t_r$	Rise time		-	55.5	-	ns
$t_{d(off)}$	Turn-off-delay time		-	28.6	-	ns
$t_f$	Fall time		-	15	-	ns

Table 7. Source drain diode

Symbol	Parameter	Test conditions	Min.	Typ.	Max.	Unit
$V_{SD}^{(1)}$	Forward on voltage	$V_{GS} = 0 \text{ V}$ , $I_{SD} = 46 \text{ A}$	-		1.2	V
$t_{rr}$	Reverse recovery time	$I_{SD} = 46 \text{ A}$ , $di/dt = 100 \text{ A}/\mu\text{s}$ , $V_{DD} = 48 \text{ V}$	-	48.4		ns
$Q_{rr}$	Reverse recovery charge		-	47		nC
$I_{RRM}$	Reverse recovery current		-	2.0		A

1. Pulse test: pulse duration = 300  $\mu\text{s}$ , duty cycle 1.5%

## 2.1 Electrical characteristics (curves)

Figure 2. Safe operating area

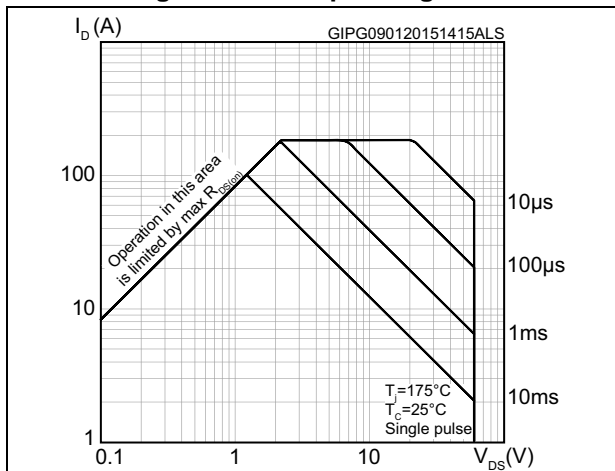

Figure 3. Thermal impedance

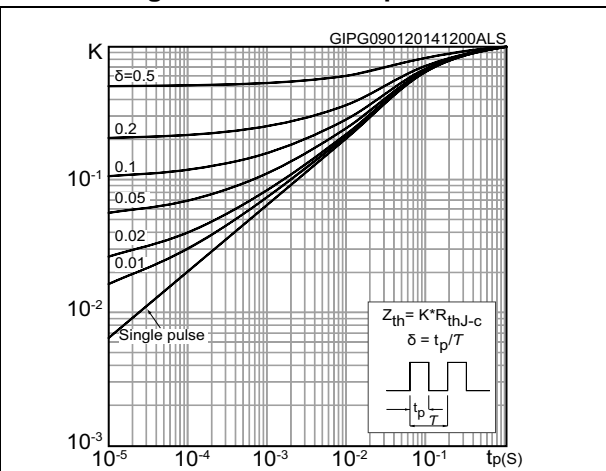

Figure 4. Output characteristics

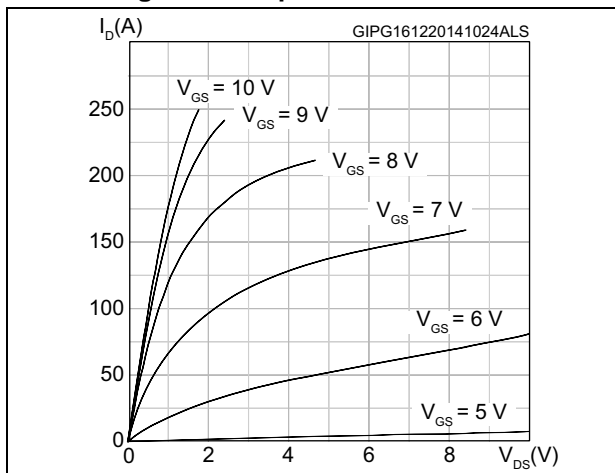

Figure 5. Transfer characteristics

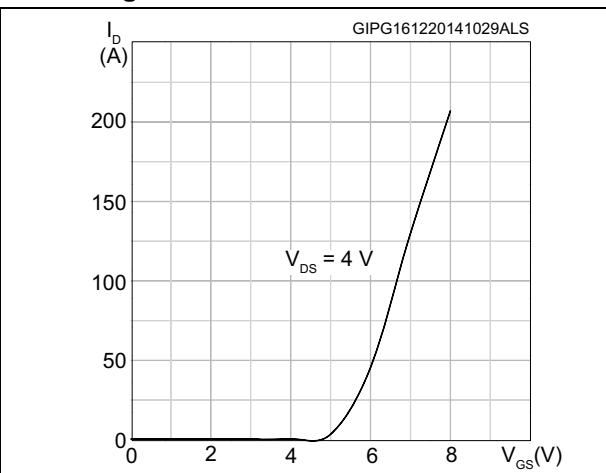

Figure 6. Gate charge vs gate-source voltage

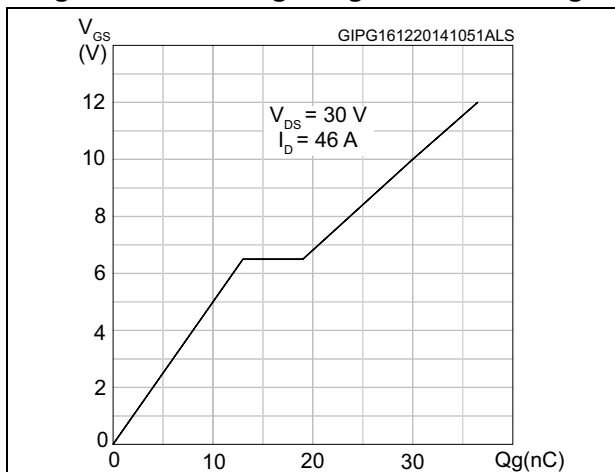

Figure 7. Static drain-source on-resistance

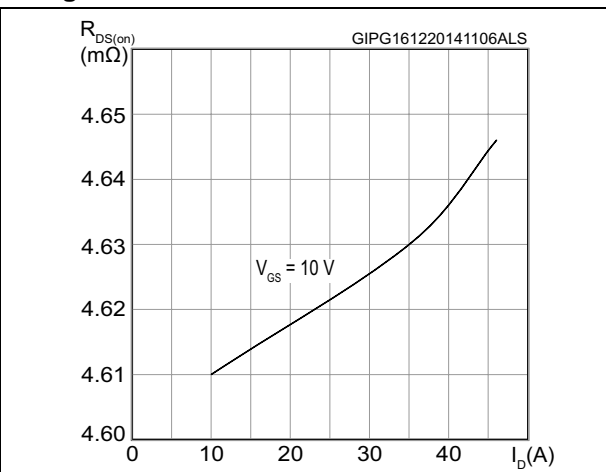

Figure 8. Capacitance variations

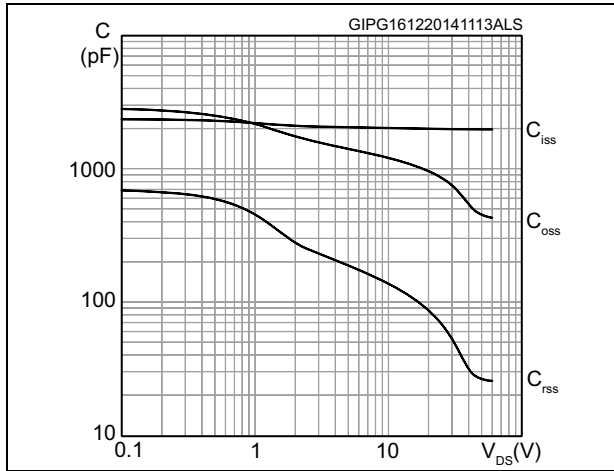

Figure 9. Normalized gate threshold voltage vs temperature

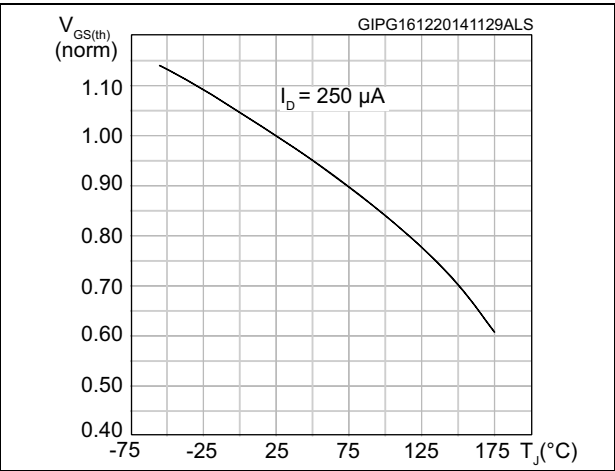

Figure 10. Normalized on-resistance vs temperature

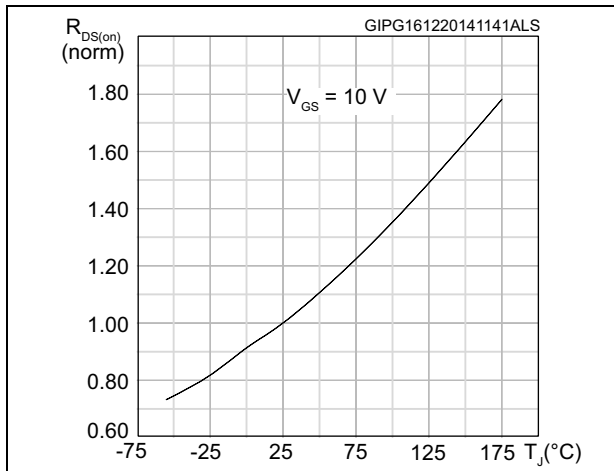

Figure 11. Source-drain diode forward characteristics

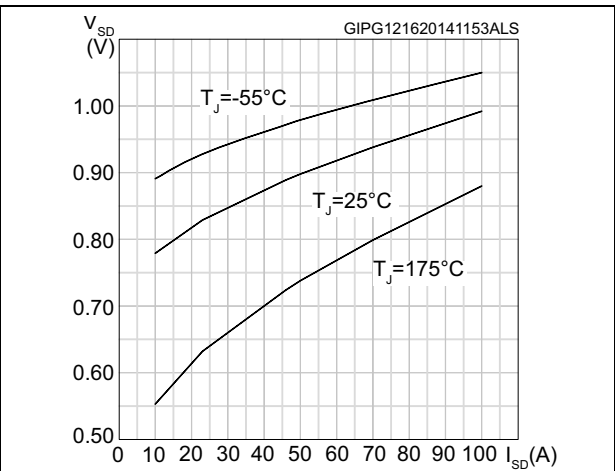
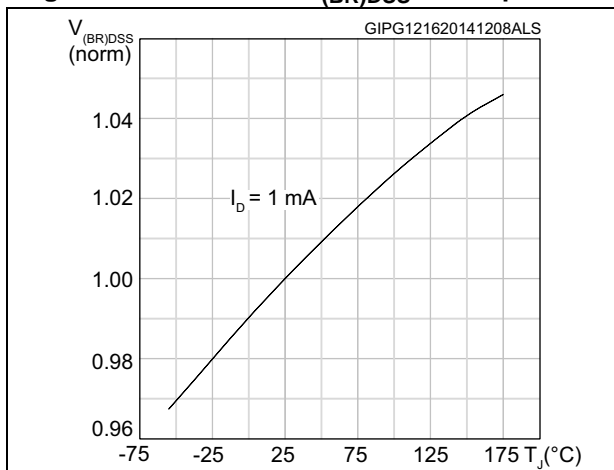

Figure 12. Normalized  $V_{(BR)DSS}$  vs temperature







## 4 Package mechanical data

In order to meet environmental requirements, ST offers these devices in different grades of ECOPACK<sup>®</sup> packages, depending on their level of environmental compliance. ECOPACK<sup>®</sup> specifications, grade definitions and product status are available at: [www.st.com](http://www.st.com). ECOPACK<sup>®</sup> is an ST trademark.

Figure 19. TO-220FP drawing

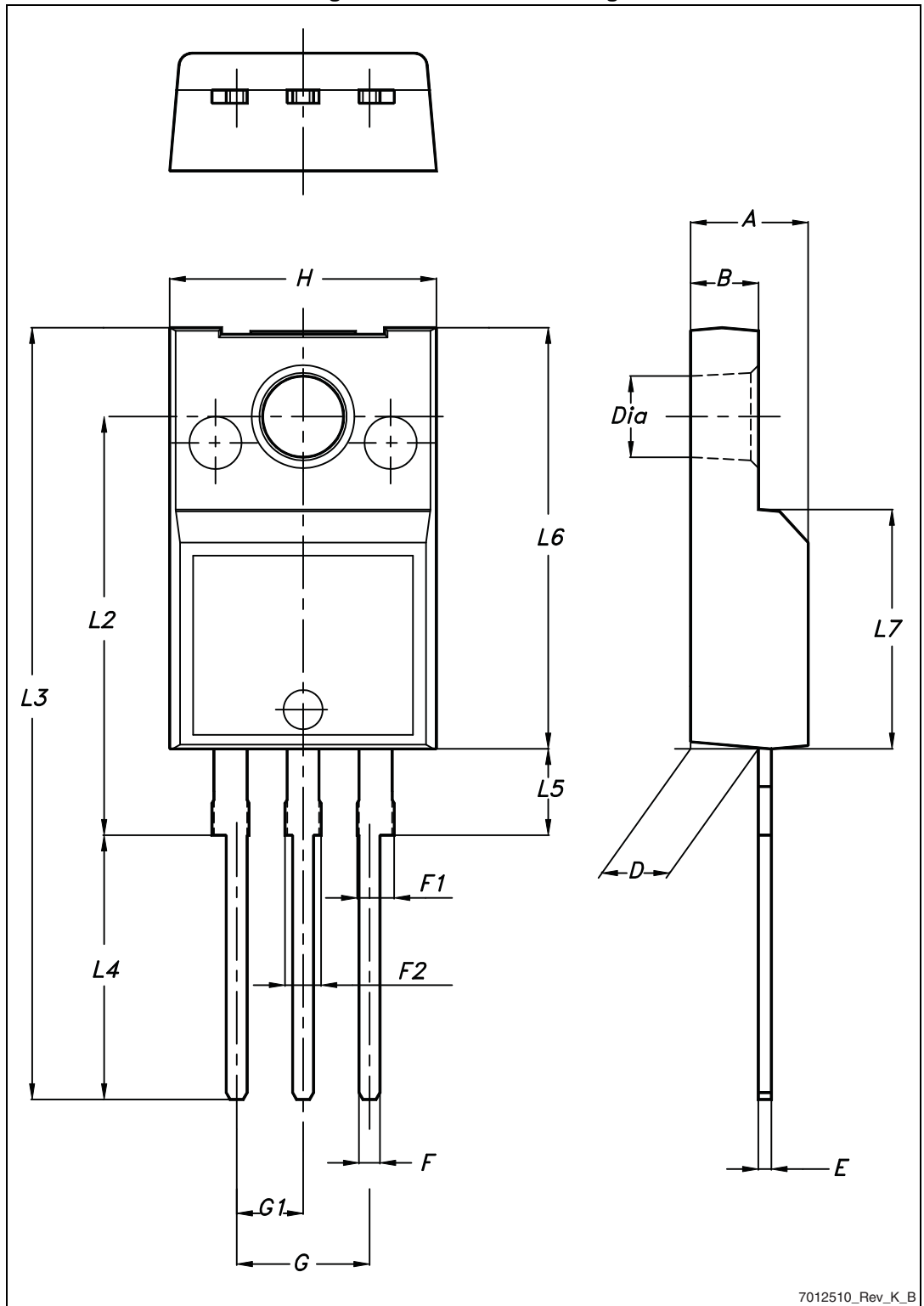

7012510\_Rev\_K\_B

Table 8. TO-220FP mechanical data

Dim.	mm		
	Min.	Typ.	Max.
A	4.4		4.6
B	2.5		2.7
D	2.5		2.75
E	0.45		0.7
F	0.75		1
F1	1.15		1.70
F2	1.15		1.70
G	4.95		5.2
G1	2.4		2.7
H	10		10.4
L2		16	
L3	28.6		30.6
L4	9.8		10.6
L5	2.9		3.6
L6	15.9		16.4
L7	9		9.3
Ø	3		3.2

## 5 Revision history

**Table 9. Document revision history**

Date	Revision	Changes
25-Nov-2014	1	First release.
16-Jan-2015	2	In <a href="#">Section 1</a> , updated <a href="#">Table 2: Absolute maximum ratings</a> In <a href="#">Section 2</a> , – updated <a href="#">Table 4: On/off states</a> – updated <a href="#">Table 5: Dynamic</a> – updated <a href="#">Table 6: Switching times</a> – updated <a href="#">Table 7: Source drain diode</a> Added <a href="#">Section 2.1: Electrical characteristics (curves)</a>
10-Feb-2015	3	Inserted dV/dt value in <a href="#">Table 2: Absolute maximum ratings</a> .

**IMPORTANT NOTICE – PLEASE READ CAREFULLY**

STMicroelectronics NV and its subsidiaries ("ST") reserve the right to make changes, corrections, enhancements, modifications, and improvements to ST products and/or to this document at any time without notice. Purchasers should obtain the latest relevant information on ST products before placing orders. ST products are sold pursuant to ST's terms and conditions of sale in place at the time of order acknowledgement.

Purchasers are solely responsible for the choice, selection, and use of ST products and ST assumes no liability for application assistance or the design of Purchasers' products.

No license, express or implied, to any intellectual property right is granted by ST herein.

Resale of ST products with provisions different from the information set forth herein shall void any warranty granted by ST for such product.

ST and the ST logo are trademarks of ST. All other product or service names are the property of their respective owners.

Information in this document supersedes and replaces information previously supplied in any prior versions of this document.

© 2015 STMicroelectronics – All rights reserved

# Mouser Electronics

Authorized Distributor

Click to View Pricing, Inventory, Delivery & Lifecycle Information:

[STMicroelectronics:](#)

[STF100N6F7](#)