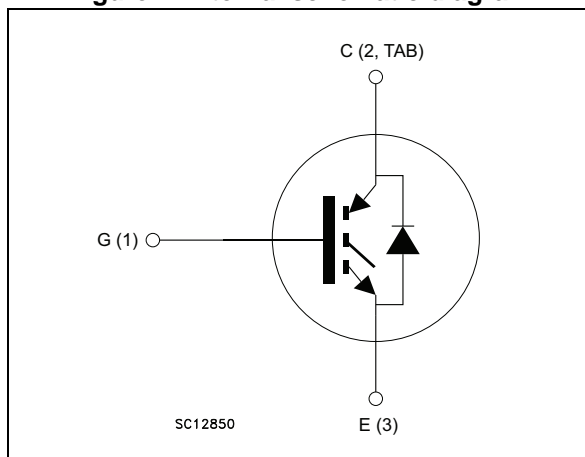

Figure 1. Internal schematic diagram



### Features

- Designed for soft commutation only
- Maximum junction temperature:  $T_J = 175\text{ °C}$
- High speed switching series
- Minimized tail current
- $V_{CE(sat)} = 1.55\text{ V (typ.) @ } I_C = 30\text{ A}$
- Low  $V_F$  soft recovery co-packaged diode
- Tight parameters distribution
- Safe paralleling
- Low thermal resistance
- Lead free package

### Applications

- Microwave oven
- Resonant converters

### Description

These devices are IGBTs developed using an advanced proprietary trench gate and field stop structure. The device is part of the new "HB" series of IGBTs, which represent an optimum compromise between conduction and switching losses to maximize the efficiency of any frequency converter. Furthermore, a slightly positive  $V_{CE(sat)}$  temperature coefficient and very tight parameter distribution result in safer paralleling operation.

Table 1. Device summary

Order code	Marking	Package	Packaging
STGB30H60DLFB	GB30H60DLFB	D <sup>2</sup> PAK	Tape and reel
STGW30H60DLFB	GW30H60DLFB	TO-247	Tube

# Contents

- 1      Electrical ratings ..... 3**
- 2      Electrical characteristics ..... 4**
  - 2.1    Electrical characteristics (curve) ..... 6
- 3      Test circuits ..... 11**
- 4      Package mechanical data ..... 12**
  - 4.1    D<sup>2</sup>PAK, STGB30H60DLFB ..... 12
  - 4.2    TO-247, STGW30H60DLFB ..... 15
- 5      Packaging mechanical data ..... 17**
- 6      Revision history ..... 19**

# 1 Electrical ratings

**Table 2. Absolute maximum ratings**

Symbol	Parameter	Value	Unit
$V_{CES}$	Collector-emitter voltage ( $V_{GE} = 0$ )	600	V
$I_C$	Continuous collector current at $T_C = 25\text{ °C}$	60	A
$I_C$	Continuous collector current at $T_C = 100\text{ °C}$	30	A
$I_{CP}^{(1)}$	Pulsed collector current	120	A
$I_F$	Continuous forward current $T_C = 25\text{ °C}$	60	A
	Continuous forward current $T_C = 25\text{ °C}$	30	A
$I_{FP}^{(1)}$	Pulsed forward current	120	A
$V_{GE}$	Gate-emitter voltage	$\pm 20$	V
$P_{TOT}$	Total dissipation at $T_C = 25\text{ °C}$	260	W
$T_{STG}$	Storage temperature range	- 55 to 150	°C
$T_J$	Operating junction temperature	- 55 to 175	°C

1. Pulse width limited by maximum junction temperature.

**Table 3. Thermal data**

Symbol	Parameter	Value		Unit
		D <sup>2</sup> PAK	TO-247	
$R_{thJC}$	Thermal resistance junction-case IGBT	0.58		°C/W
	Thermal resistance junction-case diode	2.08		°C/W
$R_{thJA}$	Thermal resistance junction-ambient	62.5	50	°C/W

## 2 Electrical characteristics

$T_J = 25\text{ °C}$  unless otherwise specified.

**Table 4. Static characteristics**

Symbol	Parameter	Test conditions	Min.	Typ.	Max.	Unit
$V_{(BR)CES}$	Collector-emitter breakdown voltage ( $V_{GE} = 0$ )	$I_C = 2\text{ mA}$	600			V
$V_{CE(sat)}$	Collector-emitter saturation voltage	$V_{GE} = 15\text{ V}, I_C = 30\text{ A}$		1.55	2	V
		$V_{GE} = 15\text{ V}, I_C = 30\text{ A}$ $T_J = 125\text{ °C}$		1.65		
		$V_{GE} = 15\text{ V}, I_C = 30\text{ A}$ $T_J = 175\text{ °C}$		1.75		
$V_F$	Forward on-voltage	$I_F = 30\text{ A}$		1.4	1.7	V
		$I_F = 30\text{ A}, T_J = 125\text{ °C}$		1.2		
		$I_F = 30\text{ A}, T_J = 175\text{ °C}$		1.05		
$V_{GE(th)}$	Gate threshold voltage	$V_{CE} = V_{GE}, I_C = 1\text{ mA}$	5	6	7	V
$I_{CES}$	Collector cut-off current ( $V_{GE} = 0$ )	$V_{CE} = 600\text{ V}$			25	$\mu\text{A}$
$I_{GES}$	Gate-emitter leakage current ( $V_{CE} = 0$ )	$V_{GE} = \pm 20\text{ V}$			250	nA

**Table 5. Dynamic characteristics**

Symbol	Parameter	Test conditions	Min.	Typ.	Max.	Unit
$C_{ies}$	Input capacitance	$V_{CE} = 25\text{ V}, f = 1\text{ MHz},$ $V_{GE} = 0$	-	3659	-	pF
$C_{oes}$	Output capacitance		-	101	-	pF
$C_{res}$	Reverse transfer capacitance		-	76	-	pF
$Q_g$	Total gate charge	$V_{CC} = 520\text{ V}, I_C = 30\text{ A},$ $V_{GE} = 15\text{ V},$ see <a href="#">Figure 26</a>	-	149	-	nC
$Q_{ge}$	Gate-emitter charge		-	25	-	nC
$Q_{gc}$	Gate-collector charge		-	62	-	nC

Table 6. IGBT switching characteristics (inductive load)

Symbol	Parameter	Test conditions	Min.	Typ.	Max.	Unit
$t_{d(off)}$	Turn-off delay time	$V_{CE} = 400\text{ V}$ , $I_C = 30\text{ A}$ , $R_G = 10\ \Omega$ , $V_{GE} = 15\text{ V}$ , see <a href="#">Figure 25</a>		146	-	ns
$t_f$	Current fall time		-	23	-	ns
$E_{off}^{(1)}$	Turn-off switching losses		-	293	-	$\mu\text{J}$
$t_{d(off)}$	Turn-off delay time	$V_{CE} = 400\text{ V}$ , $I_C = 30\text{ A}$ , $R_G = 10\ \Omega$ , $V_{GE} = 15\text{ V}$ , $T_J = 175\text{ }^\circ\text{C}$ , see <a href="#">Figure 25</a>	-	158	-	ns
$t_f$	Current fall time		-	65	-	ns
$E_{off}^{(1)}$	Turn-off switching losses		-	572	-	$\mu\text{J}$

1. Turn-off losses include also the tail of the collector current.

Table 7. IGBT switching characteristics (capacitive load)

Symbol	Parameter	Test conditions	Min.	Typ.	Max.	Unit
$E_{off}^{(1)}$	Turn-off switching losses	$V_{CC} = 320\text{ V}$ , $V_{GE} = 150\text{ V}$ , $R_G = 20\ \Omega$ , $I_C = 30\text{ A}$ , $L = 100\ \mu\text{H}$ , $C_{snub} = 20\text{ nF}$ (see <a href="#">Figure 25</a> )	-	150	-	$\mu\text{J}$
		$V_{CC} = 320\text{ V}$ , $V_{GE} = 150\text{ V}$ , $R_G = 20\ \Omega$ , $I_C = 30\text{ A}$ , $L = 100\ \mu\text{H}$ , $C_{snub} = 20\text{ nF}$ , $T_J = 175\text{ }^\circ\text{C}$ (see <a href="#">Figure 25</a> )	-	300	-	

1. Turn-off losses include also the tail of the collector current.

## 2.1 Electrical characteristics (curve)

Figure 2. Power dissipation vs. case temperature

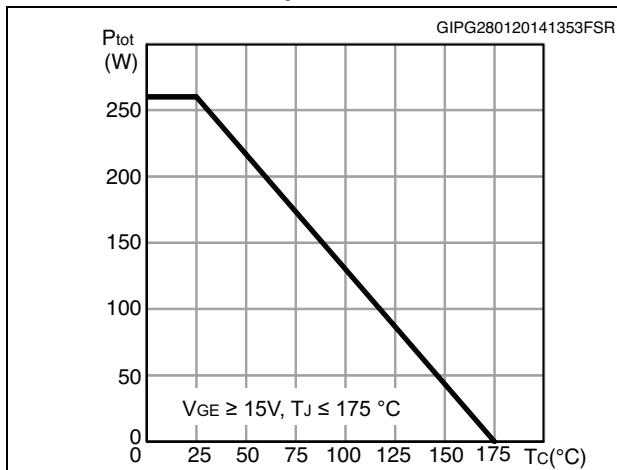

Figure 3. Collector current vs. case temperature

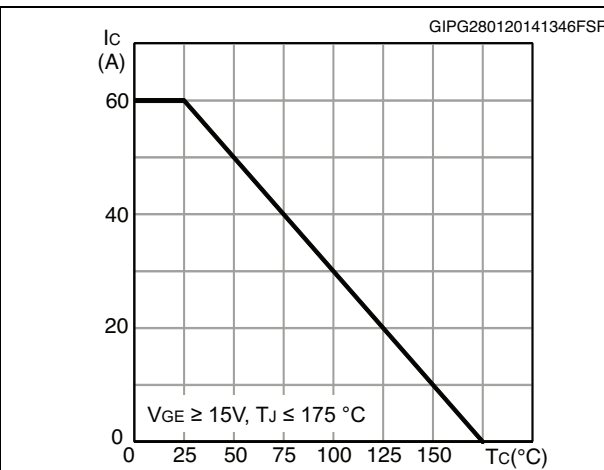

Figure 4. Output characteristics (T<sub>J</sub> = 25°C)

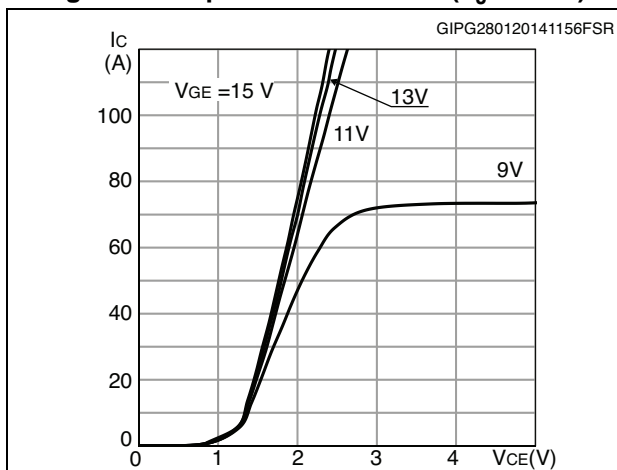

Figure 5. Output characteristics (T<sub>J</sub> = 175°C)

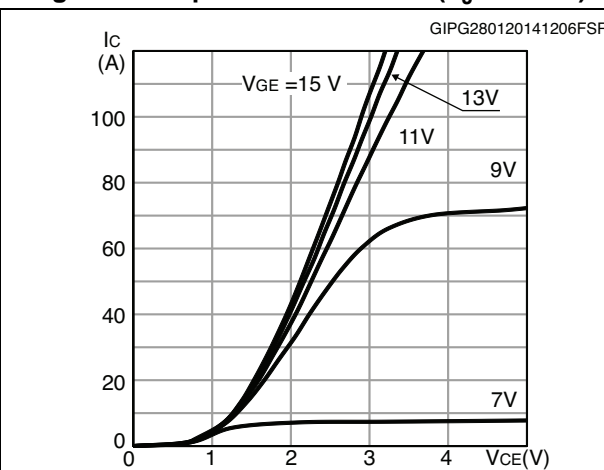

Figure 6. V<sub>CE(sat)</sub> vs. junction temperature

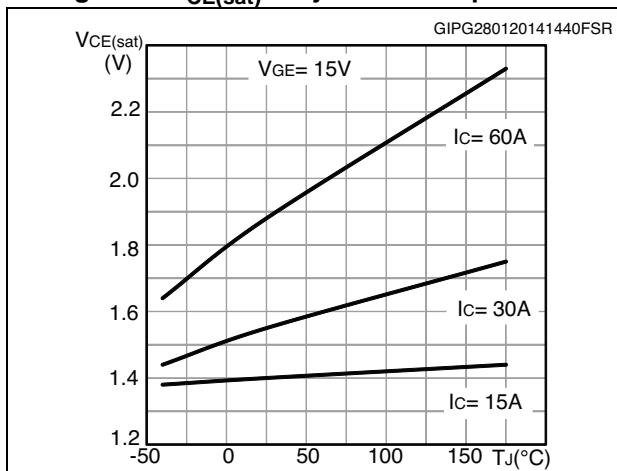

Figure 7. V<sub>CE(sat)</sub> vs. collector current

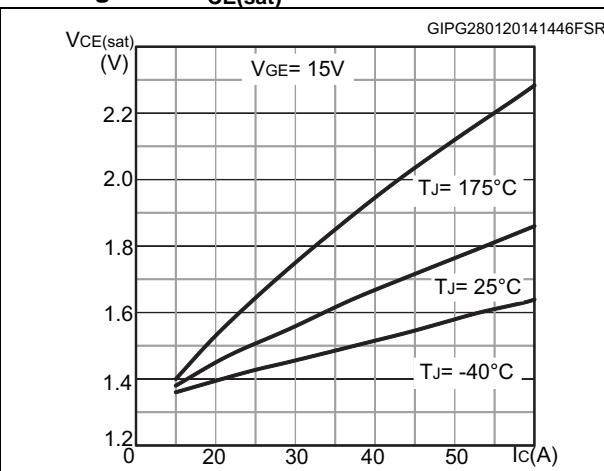

Figure 8. Collector current vs. switching frequency

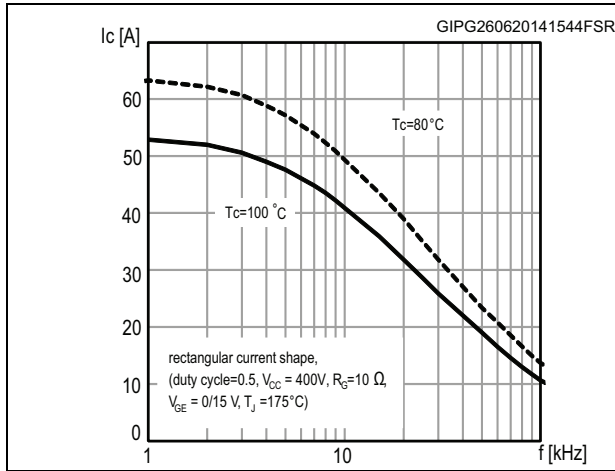

Figure 9. Forward bias safe operating area

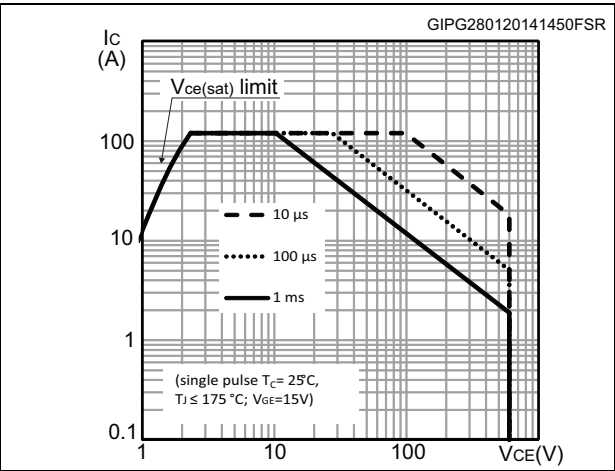

Figure 10. Transfer characteristics

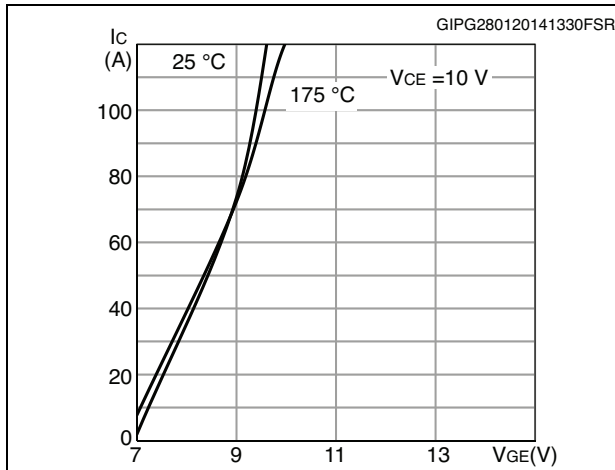

Figure 11. Diode  $V_F$  vs. forward current

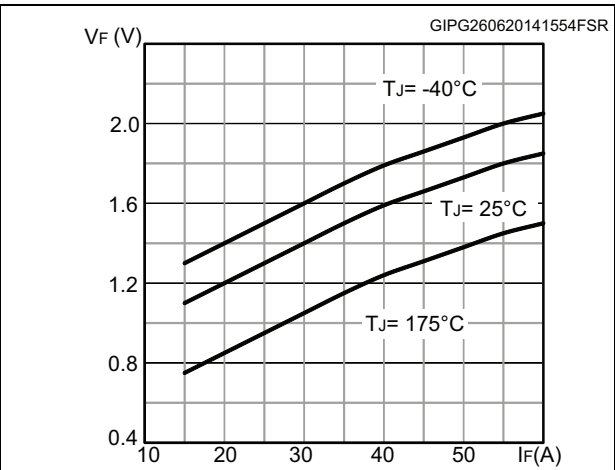

Figure 12. Normalized  $V_{GE(th)}$  vs junction temperature

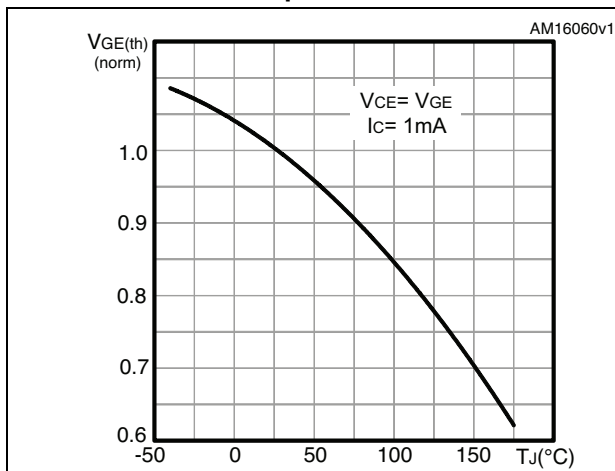

Figure 13. Normalized  $V_{(BR)CES}$  vs. junction temperature

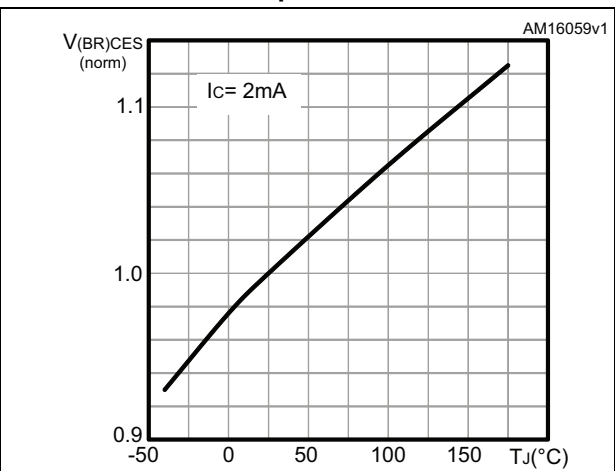

Figure 14. Capacitance variation

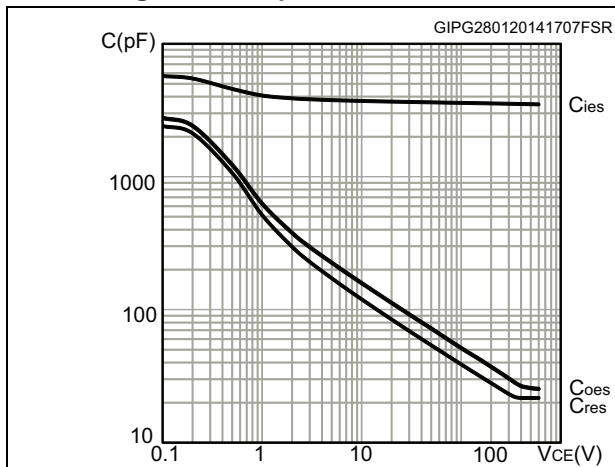

Figure 15. Gate charge vs. gate-emitter voltage

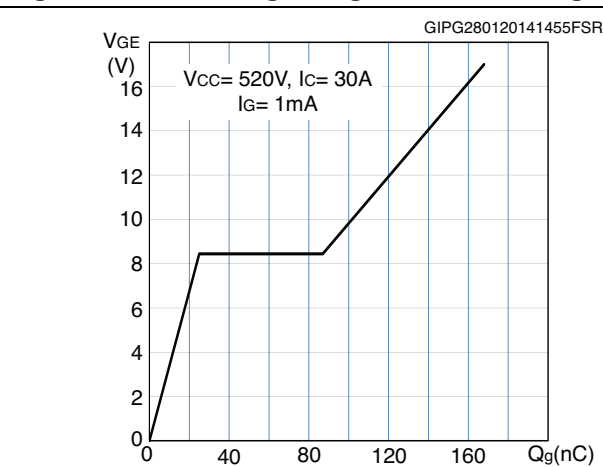

Figure 16. Switching loss vs collector current

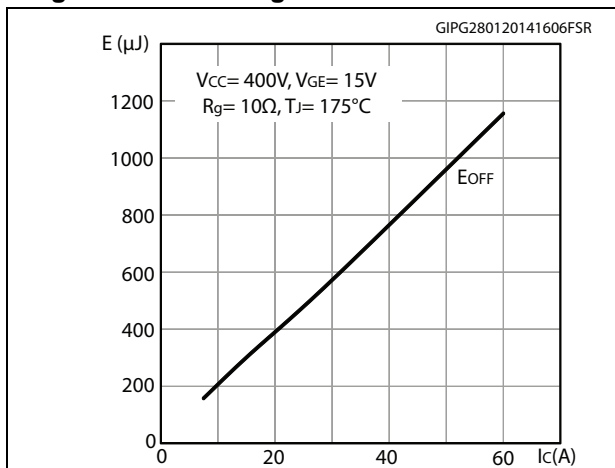

Figure 17. Switching loss vs gate resistance

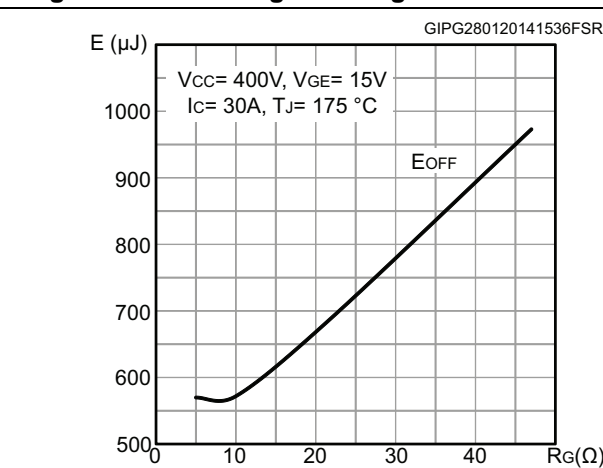

Figure 18. Switching loss vs temperature

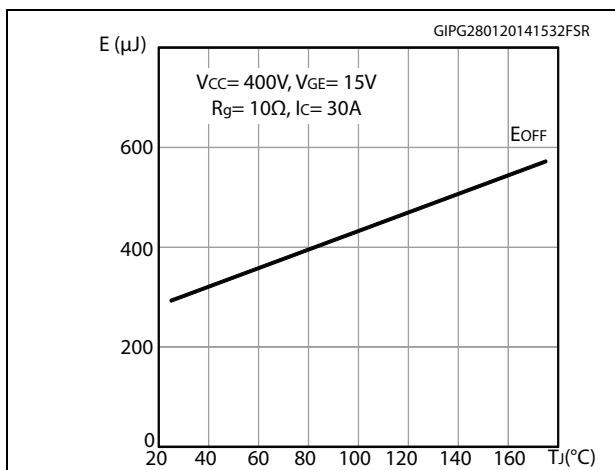

Figure 19. Switching loss vs collector-emitter voltage

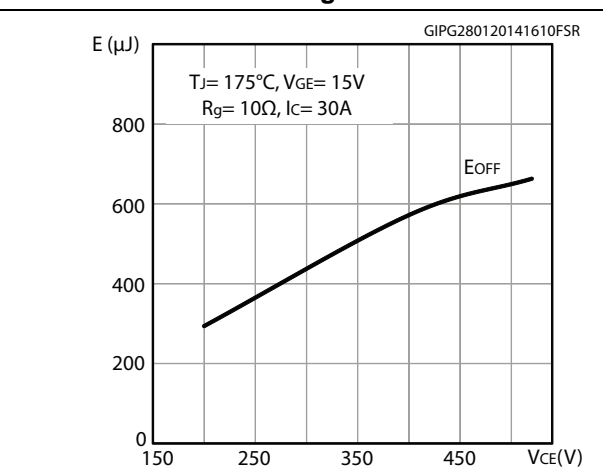



Figure 20. Switching times vs. collector current      Figure 21. Switching times vs. gate resistance

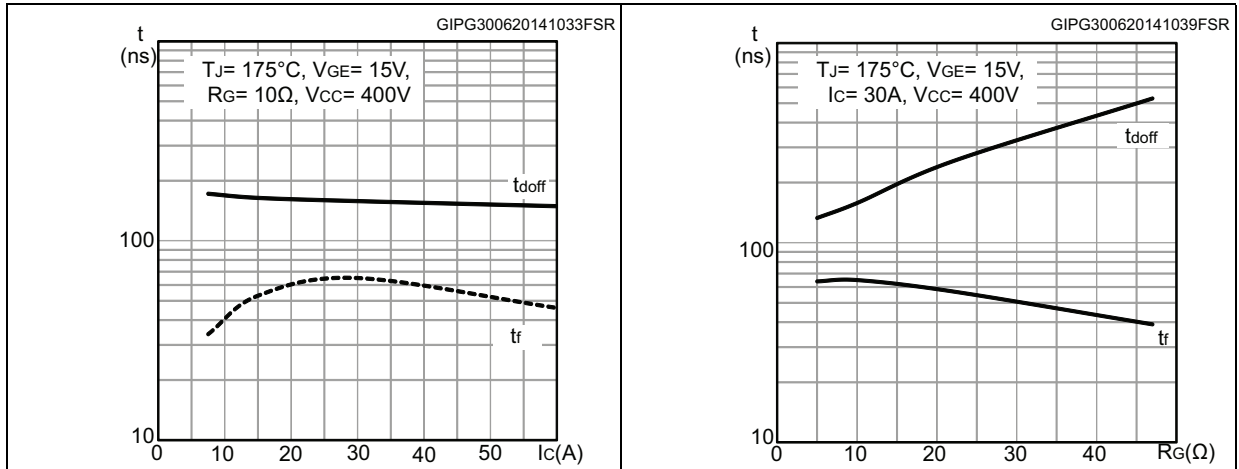

Figure 22. Switching-off losses vs. capacitive load

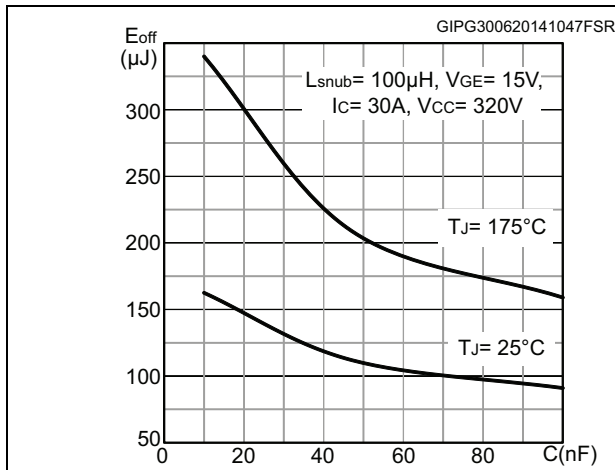

Figure 23. Thermal impedance for IGBT

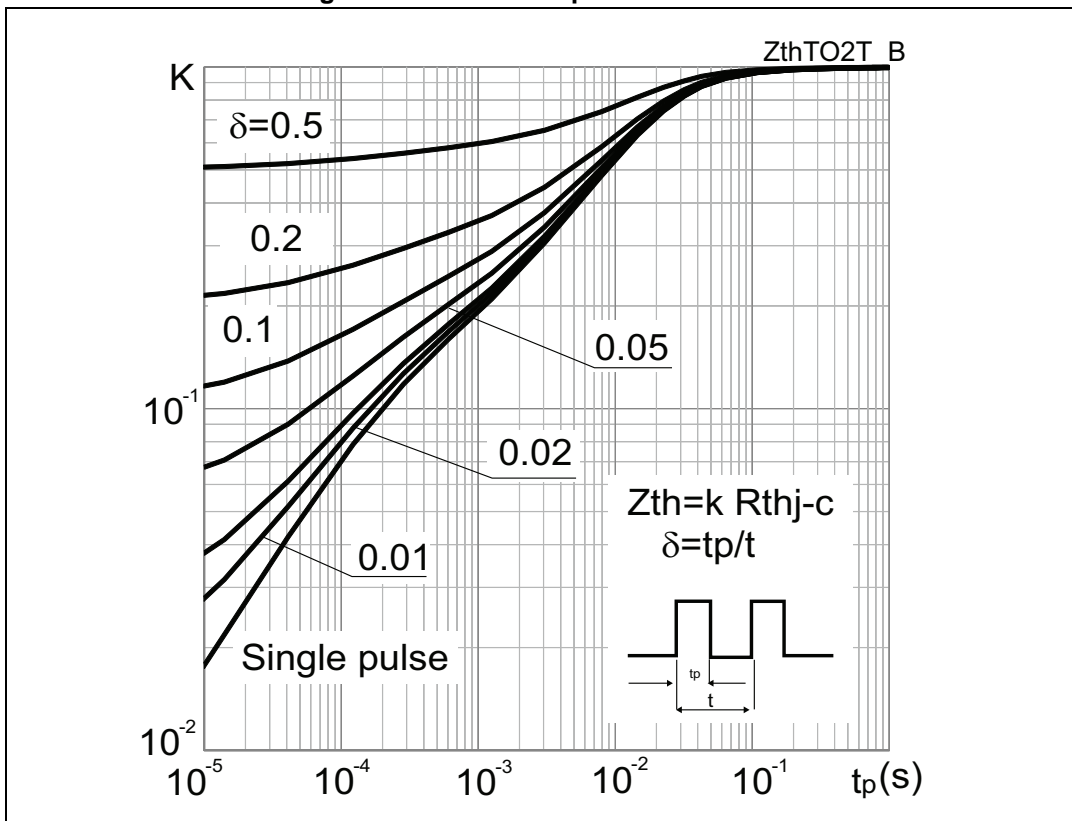
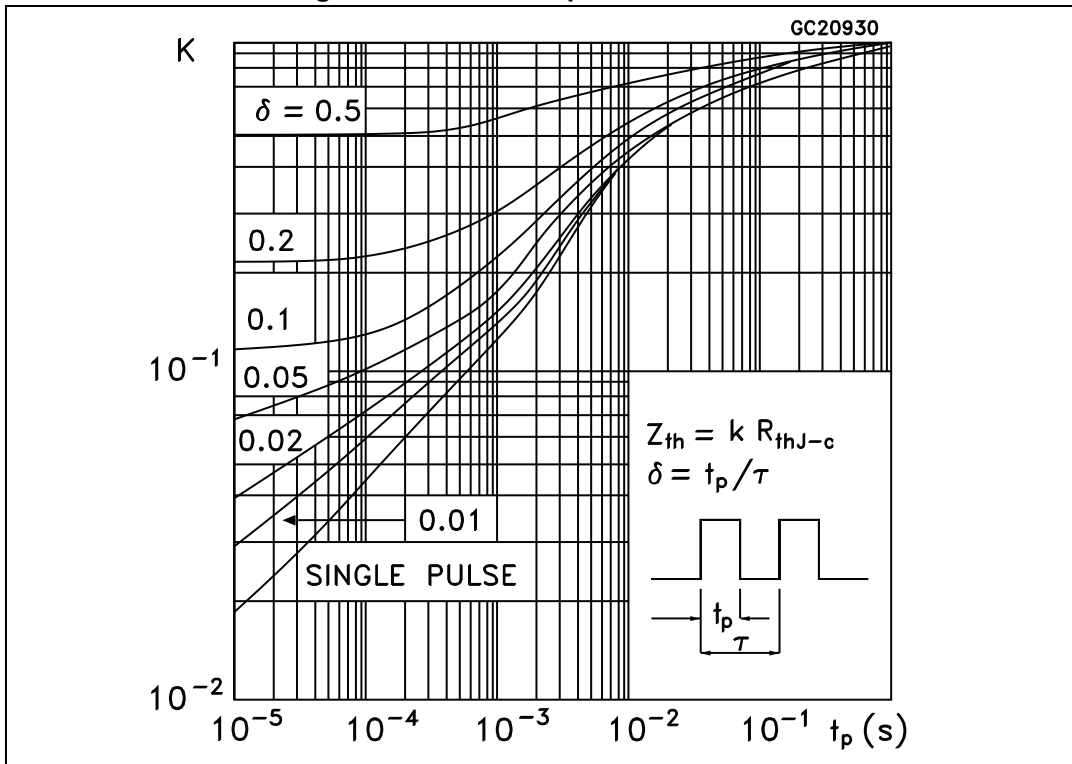

Figure 24. Thermal impedance for diode



### 3 Test circuits

Figure 25. Test circuit for inductive load switching



Figure 26. Gate charge test circuit

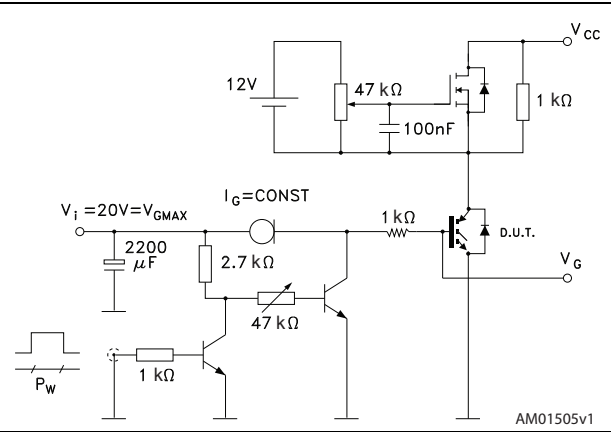
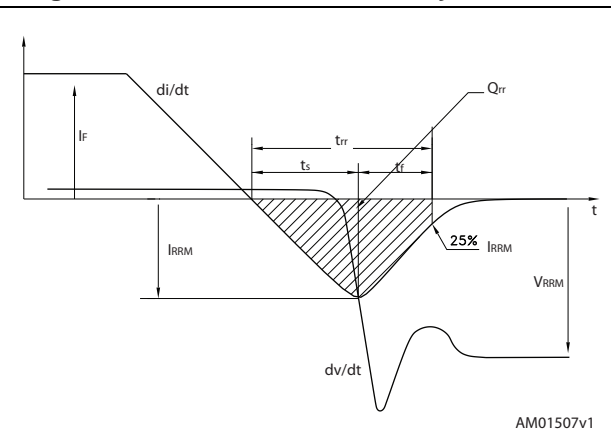

Figure 27. Switching waveform



Figure 28. Diode reverse recovery waveform



## 4 Package mechanical data

In order to meet environmental requirements, ST offers these devices in different grades of ECOPACK<sup>®</sup> packages, depending on their level of environmental compliance. ECOPACK<sup>®</sup> specifications, grade definitions and product status are available at: [www.st.com](http://www.st.com). ECOPACK is an ST trademark.

### 4.1 D<sup>2</sup>PAK, STGB30H60DLFB

Figure 29. D<sup>2</sup>PAK (TO-263) drawing

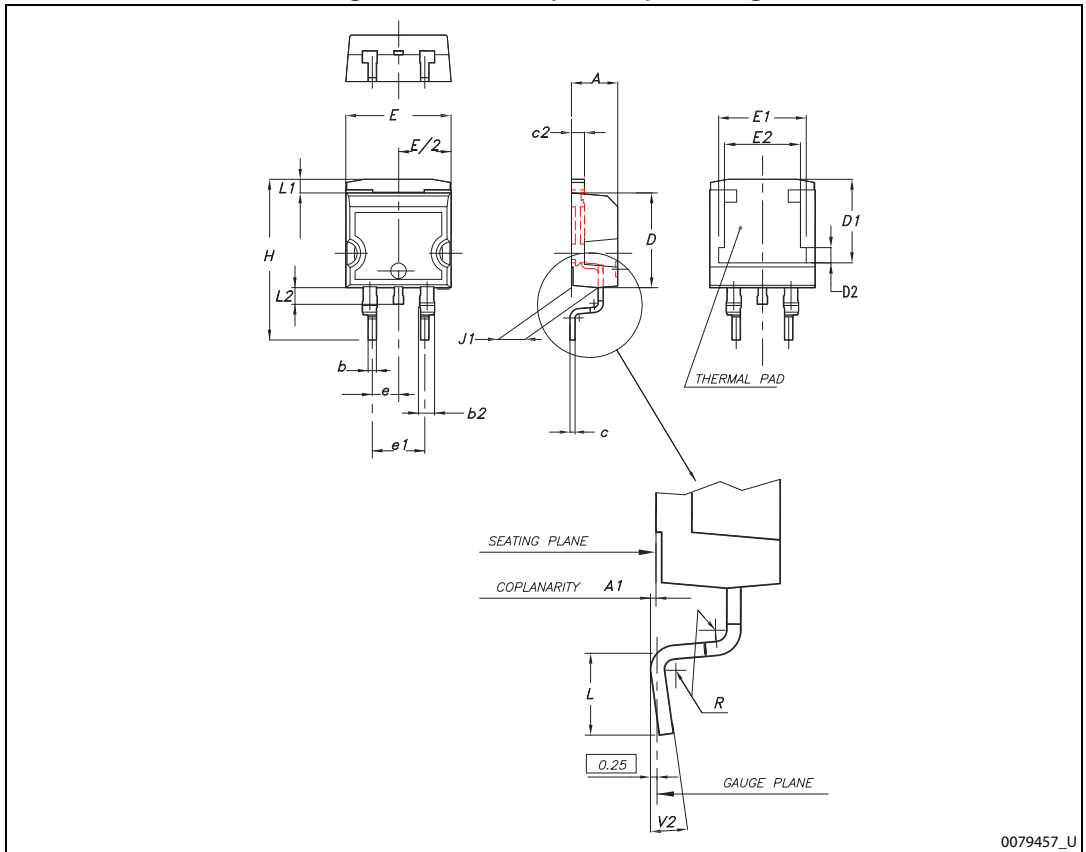
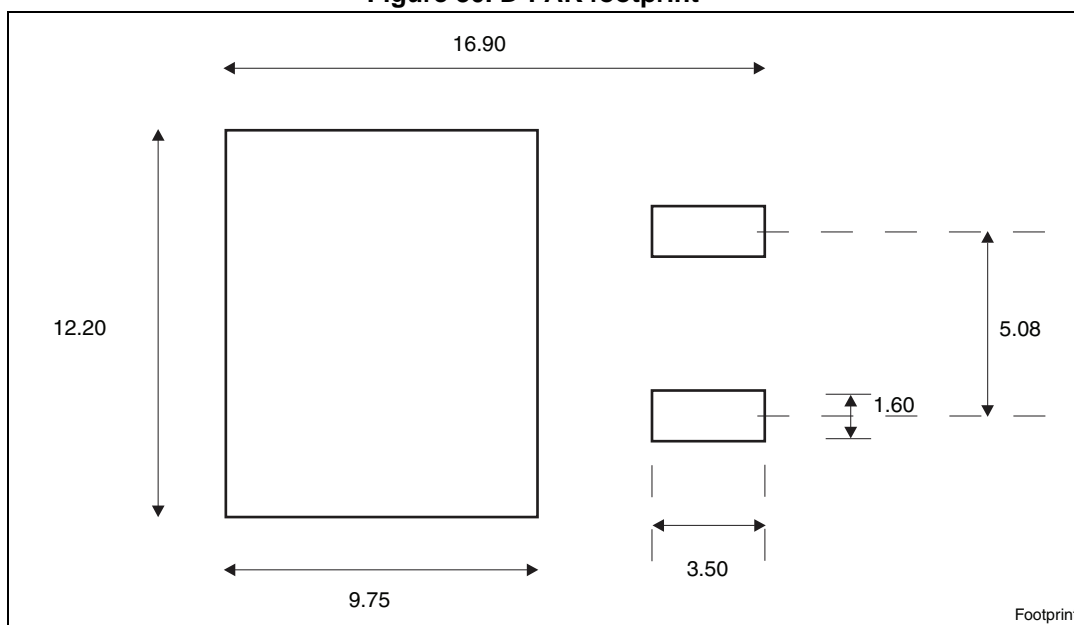

Table 8. D<sup>2</sup>PAK (TO-263) mechanical data

Dim.	mm		
	Min.	Typ.	Max.
A	4.40		4.60
A1	0.03		0.23
b	0.70		0.93
b2	1.14		1.70
c	0.45		0.60
c2	1.23		1.36
D	8.95		9.35
D1	7.50	7.75	8.00
D2	1.10	1.30	1.50
E	10		10.40
E1	8.50	8.70	8.90
E2	6.85	7.05	7.25
e		2.54	
e1	4.88		5.28
H	15		15.85
J1	2.49		2.69
L	2.29		2.79
L1	1.27		1.40
L2	1.30		1.75
R		0.4	
V2	0°		8°

Figure 30. D<sup>2</sup>PAK footprint<sup>(a)</sup>



a. All dimension are in millimeters.

### 4.2 TO-247, STGW30H60DLFB

Figure 31. TO-247 drawing

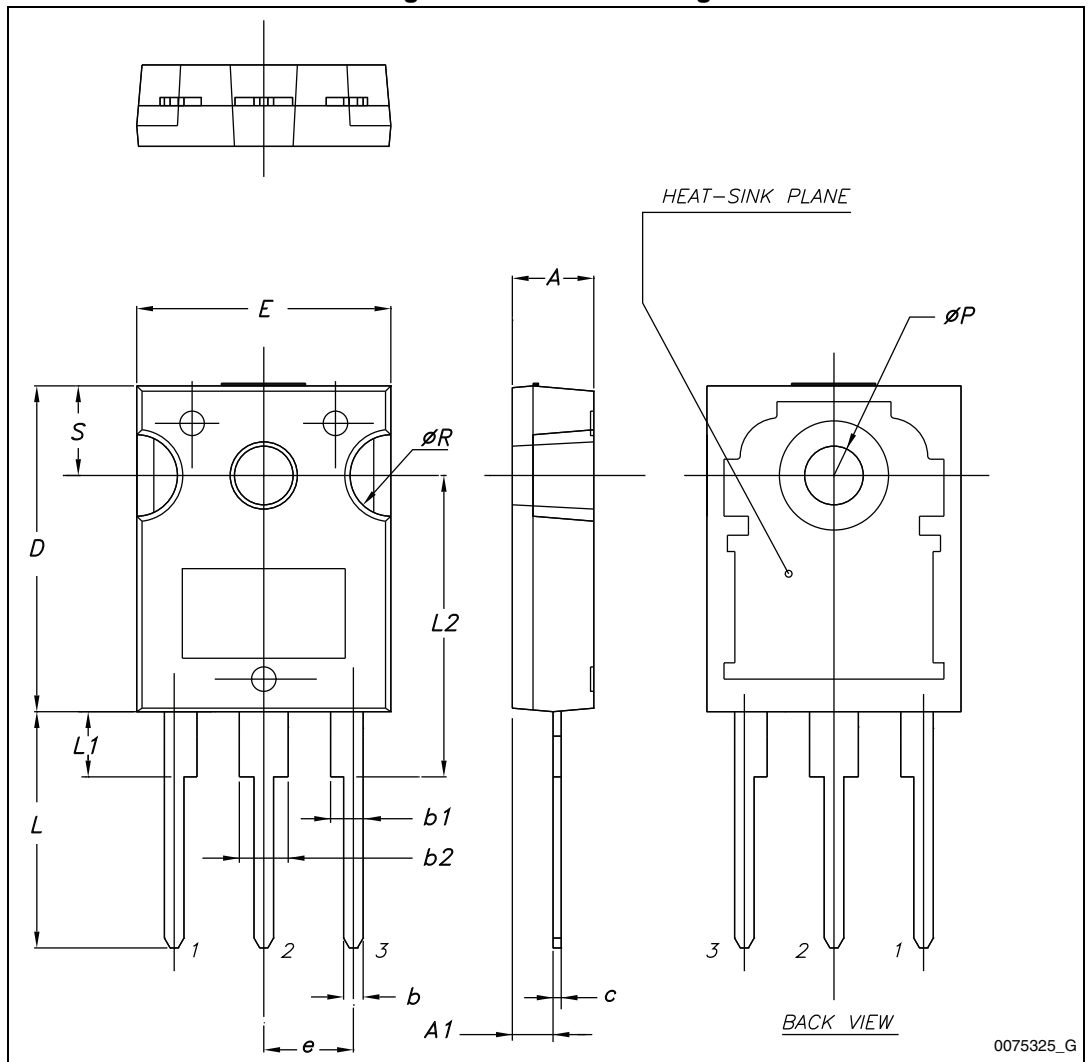

Table 9. TO-247 mechanical data

Dim.	mm.		
	Min.	Typ.	Max.
A	4.85		5.15
A1	2.20		2.60
b	1.0		1.40
b1	2.0		2.40
b2	3.0		3.40
c	0.40		0.80
D	19.85		20.15
E	15.45		15.75
e	5.30	5.45	5.60
L	14.20		14.80
L1	3.70		4.30
L2		18.50	
ØP	3.55		3.65
ØR	4.50		5.50
S	5.30	5.50	5.70



# 5 Packaging mechanical data

Figure 32. Tape

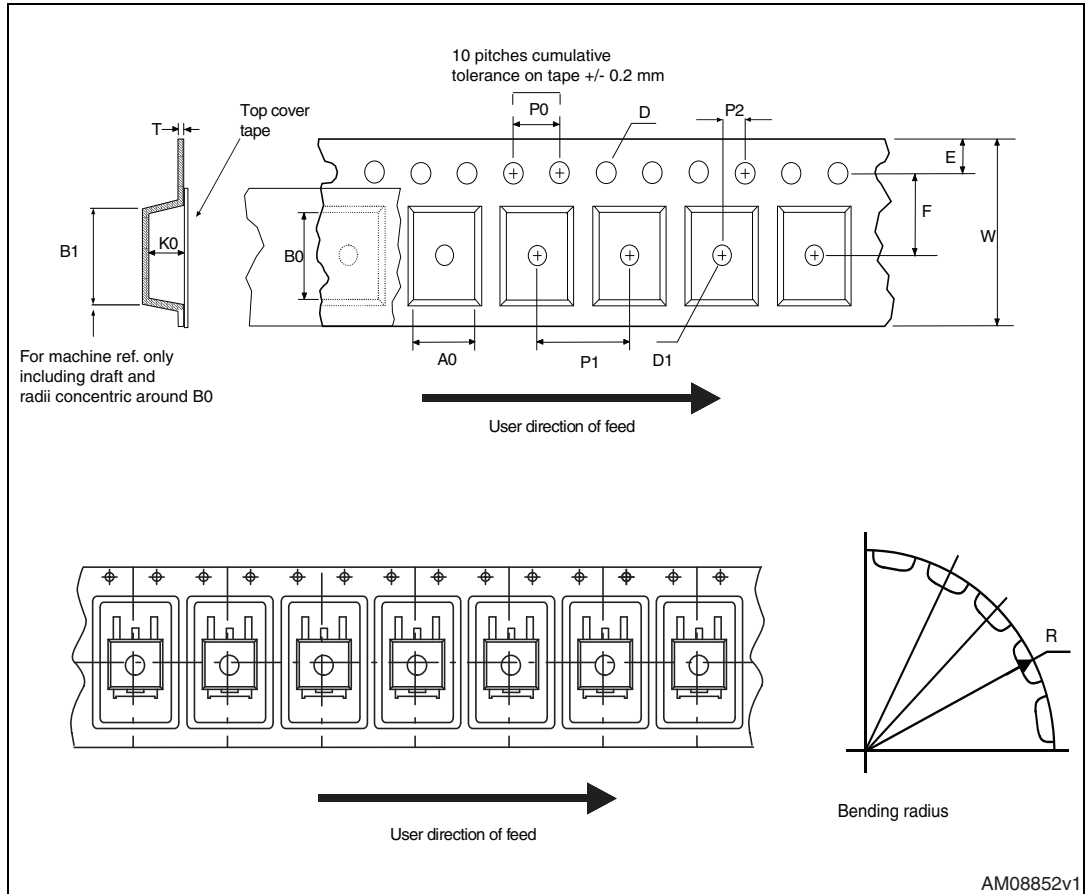
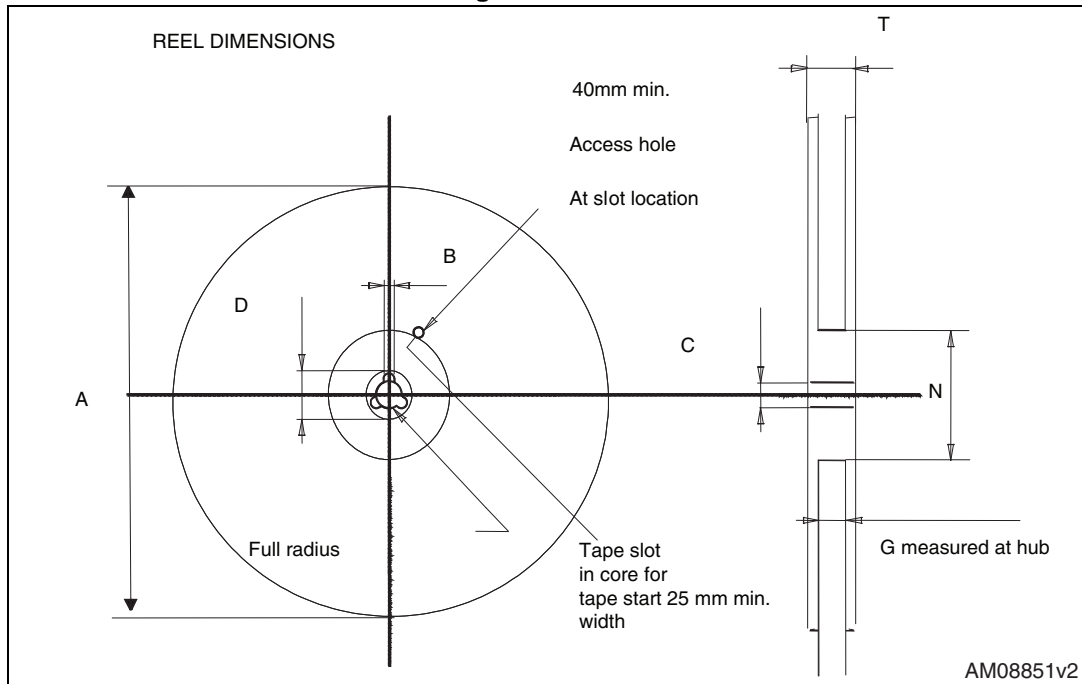

Figure 33. Reel



AM08851v2

Table 10. D<sup>2</sup>PAK (TO-263) tape and reel mechanical data

Tape			Reel		
Dim.	mm		Dim.	mm	
	Min.	Max.		Min.	Max.
A0	10.5	10.7	A		330
B0	15.7	15.9	B	1.5	
D	1.5	1.6	C	12.8	13.2
D1	1.59	1.61	D	20.2	
E	1.65	1.85	G	24.4	26.4
F	11.4	11.6	N	100	
K0	4.8	5.0	T		30.4
P0	3.9	4.1			
P1	11.9	12.1	Base qty		1000
P2	1.9	2.1	Bulk qty		1000
R	50				
T	0.25	0.35			
W	23.7	24.3			

## 6 Revision history

Table 11. Document revision history

Date	Revision	Changes
04-Jul-2014	1	Initial release.
23-Jul-2014	2	Document status promoted from preliminary data to production data

**IMPORTANT NOTICE – PLEASE READ CAREFULLY**

STMicroelectronics NV and its subsidiaries ("ST") reserve the right to make changes, corrections, enhancements, modifications, and improvements to ST products and/or to this document at any time without notice. Purchasers should obtain the latest relevant information on ST products before placing orders. ST products are sold pursuant to ST's terms and conditions of sale in place at the time of order acknowledgement.

Purchasers are solely responsible for the choice, selection, and use of ST products and ST assumes no liability for application assistance or the design of Purchasers' products.

No license, express or implied, to any intellectual property right is granted by ST herein.

Resale of ST products with provisions different from the information set forth herein shall void any warranty granted by ST for such product.

ST and the ST logo are trademarks of ST. All other product or service names are the property of their respective owners.

Information in this document supersedes and replaces information previously supplied in any prior versions of this document.

© 2014 STMicroelectronics – All rights reserved

# Mouser Electronics

Authorized Distributor

Click to View Pricing, Inventory, Delivery & Lifecycle Information:

[STMicroelectronics:](#)

[STGW30H60DLFB](#) [STGB30H60DLFB](#)