

1.2 V to 5.5 V, Slew Rate Controlled Load Switch in TSOT23-6

DESCRIPTION

SiP32510 is a slew rate controlled load switches designed for 1.2 V to 5.5 V operation.

The switch element is of n-channel device that provides low R_{ON} of 44 m Ω typically over a wide range of input.

SiP32510 has low switch on-resistance starting at 1.5 V input supply. It features a controlled soft on slew rate of typical 1.6 ms that limits the inrush current for designs of heavy capacitive load and minimizes the resulting voltage droop at the power rails. With a typical turn on delay of 0.4 ms, the total turn on time is typically 2 ms.

The SiP32510 features a low voltage control logic interface (On/Off interface) that can interface with low voltage control signals without extra level shifting circuit.

The SiP32510 has exceptionally low shutdown current and provides reverse blocking to prevent high current flowing into the power source.

SiP32510 integrates a switch OFF output discharge circuit. SiP32510 is available in TSOT23-6 package.

FEATURES

- 1.2 V to 5.5 V operation voltage range
- Flat low R_{ON} down to 1.5 V
- 44 m Ω typical from 1.8 V to 5 V
- Slew rate controlled turn-on: 1.6 ms at 3.3 V
- Low quiescent current < 1 μ A when disabled
10.5 μ A typical at $V_{IN} = 1.2$ V
- Reverse current blocking when switch is off, with guaranteed less than 2 μ A leakage
- Material categorization: For definitions of compliance please see www.vishay.com/doc?99912



APPLICATIONS

- PDAs/smart phones
- Ultrabook and notebook computer
- Tablet devices
- Portable media players
- Digital camera
- GPS navigation devices
- Data storage devices
- Optical, industrial, medical, and healthcare devices
- Peripherals
- Office automation
- Networking

TYPICAL APPLICATION CIRCUIT

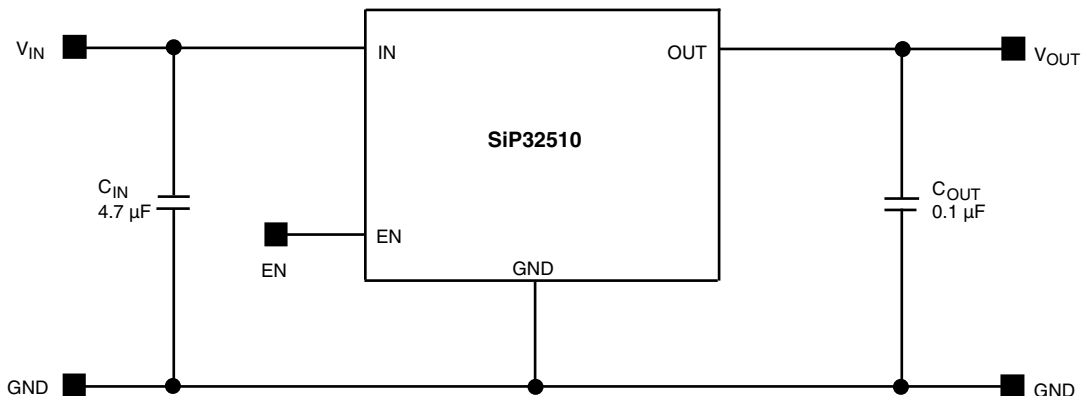

Figure 1 - SiP32510 Typical Application Circuit

ORDERING INFORMATION			
Temperature Range	Package	Marking	Part Number
- 40 °C to 85 °C	TSOT23-6	LF	SiP32510DT-T1-GE3

Note:

GE3 denotes halogen-free and RoHS compliant

ABSOLUTE MAXIMUM RATINGS		
Parameter	Limit	Unit
Supply Input Voltage (V_{IN})	- 0.3 to 6	V
Enable Input Voltage (V_{EN})	- 0.3 to 6	
Output Voltage (V_{OUT})	- 0.3 to 6	
Maximum Continuous Switch Current ($I_{max.}$) ^c	3	A
Maximum Repetitive Pulsed Current (1 ms, 10 % Duty Cycle) ^c	6	
Maximum Non-Repetitive Pulsed Current (100 μ s, EN = Active) ^c	12	
ESD Rating (HBM)	> 4	kV
ESD Rating (CDM)	1.5	
Junction Temperature (T_J)	- 40 to 150	$^{\circ}$ C
Thermal Resistance (θ_{JA}) ^a	150	$^{\circ}$ C/W
Power Dissipation (P_D) ^{a,b}	833	mW

Notes:

a. Device mounted with all leads and power pad soldered or welded to PC board, see PCB layout.

b. Derate 6.66 mW/ $^{\circ}$ C above $T_A = 25$ $^{\circ}$ C, see PCB layout.

c. $T_A = 25$ $^{\circ}$ C.

Stresses beyond those listed under "Absolute Maximum Ratings" may cause permanent damage to the device. These are stress ratings only, and functional operation of the device at these or any other conditions beyond those indicated in the operational sections of the specifications is not implied. Exposure to absolute maximum rating/conditions for extended periods may affect device reliability.

RECOMMENDED OPERATING RANGE		
Parameter	Limit	Unit
Input Voltage Range (V_{IN})	1.2 to 5.5	V
Operating Junction Temperature Range (T_J)	- 40 to 125	$^{\circ}$ C

SPECIFICATIONS						
Parameter	Symbol	Test Conditions Unless Specified $V_{IN} = 5$ V, $T_A = - 40$ $^{\circ}$ C to 85 $^{\circ}$ C (Typical values are at $T_A = 25$ $^{\circ}$ C)	Limits - 40 $^{\circ}$ C to 85 $^{\circ}$ C			Unit
			Min. ^a	Typ. ^b	Max. ^a	
Operating Voltage ^c	V_{IN}		1.2	-	5.5	V
Quiescent Current	I_Q	$V_{IN} = 1.2$ V, EN = active	-	10.5	17	μ A
		$V_{IN} = 1.8$ V, EN = active	-	21	30	
		$V_{IN} = 2.5$ V, EN = active	-	34	50	
		$V_{IN} = 3.6$ V, EN = active	-	54	90	
		$V_{IN} = 4.3$ V, EN = active	-	68	110	
		$V_{IN} = 5$ V, EN = active	-	105	180	
Off Supply Current	$I_{Q(off)}$	EN = inactive, OUT = open	-	-	1	
Off Switch Current	$I_{DS(off)}$	EN = inactive, OUT = GND	-	-	1	
Reverse Blocking Current	I_{RB}	$V_{OUT} = 5$ V, $V_{IN} = 0$ V, $V_{EN} =$ inactive	-	-	10	
On-Resistance	$R_{DS(on)}$	$V_{IN} = 1.8$ V, $I_L = 100$ mA, $T_A = 25$ $^{\circ}$ C	-	45	53	m Ω
		$V_{IN} = 2.5$ V, $I_L = 100$ mA, $T_A = 25$ $^{\circ}$ C	-	44	52	
		$V_{IN} = 3.6$ V, $I_L = 100$ mA, $T_A = 25$ $^{\circ}$ C	-	44	52	
		$V_{IN} = 4.3$ V, $I_L = 100$ mA, $T_A = 25$ $^{\circ}$ C	-	44	52	
		$V_{IN} = 5$ V, $I_L = 100$ mA, $T_A = 25$ $^{\circ}$ C	-	46	52	
On-Resistance Temp.-Coefficient	TC_{RDS}		-	3570	-	ppm/ $^{\circ}$ C

SPECIFICATIONS						
Parameter	Symbol	Test Conditions Unless Specified $V_{IN} = 5\text{ V}$, $T_A = -40\text{ }^\circ\text{C}$ to $85\text{ }^\circ\text{C}$ (Typical values are at $T_A = 25\text{ }^\circ\text{C}$)	Limits - $40\text{ }^\circ\text{C}$ to $85\text{ }^\circ\text{C}$			Unit
			Min. ^a	Typ. ^b	Max. ^a	
EN Input Low Voltage ^c	V_{IL}	$V_{IN} = 1.2\text{ V}$	-	-	0.3	V
		$V_{IN} = 1.8\text{ V}$	-	-	0.4 ^d	
		$V_{IN} = 2.5\text{ V}$	-	-	0.5 ^d	
		$V_{IN} = 3.6\text{ V}$	-	-	0.6 ^d	
		$V_{IN} = 4.3\text{ V}$	-	-	0.7 ^d	
		$V_{IN} = 5\text{ V}$	-	-	0.8 ^d	
EN Input High Voltage ^c	V_{IH}	$V_{IN} = 1.2\text{ V}$	0.9 ^d	-	-	V
		$V_{IN} = 1.8\text{ V}$	1.2 ^d	-	-	
		$V_{IN} = 2.5\text{ V}$	1.4 ^d	-	-	
		$V_{IN} = 3.6\text{ V}$	1.6 ^d	-	-	
		$V_{IN} = 4.3\text{ V}$	1.7 ^d	-	-	
		$V_{IN} = 5\text{ V}$	1.8	-	-	
EN Input Leakage	I_{SINK}	$V_{EN} = 5.5\text{ V}$	- 1	-	1	μA
Output Pulldown Resistance	R_{PD}	EN = inactive, $T_A = 25\text{ }^\circ\text{C}$	-	217	280	Ω
Switch Turn-On Response Time ^d	t_{ON_RESP}	$V_{IN} = 3.3\text{ V}$, $T_A = 25\text{ }^\circ\text{C}$	-	20	200	μs
Output Turn-On Delay Time (50 % EN to 10 % OUT)	$t_{d(on)}$	$V_{IN} = 3.3\text{ V}$, $R_{LOAD} = 10\ \Omega$, $C_{LOAD} = 0.1\ \mu\text{F}$, $T_A = 25\text{ }^\circ\text{C}$	-	0.4	-	ms
Output Turn-On Rise Time (10 % OUT to 90 % OUT)	t_r		1.3	1.6	2.2	
Output Turn-Off Delay Time (50 % EN to 90 % OUT)	$t_{d(off)}$		-	-	0.001	
Output Turn-On Time (50 % EN to 95 % OUT) ^e	$t_{(on)}$		$V_{IN} = 3.3\text{ V}$, $R_{LOAD} = 10\ \Omega$, $C_{LOAD} = 100\ \mu\text{F}$, $T_A = 25\text{ }^\circ\text{C}$	1.2	-	

Notes:

- a. The algebraic convention whereby the most negative value is a minimum and the most positive a maximum.
- b. Typical values are for DESIGN AID ONLY, not guaranteed nor subject to production testing.
- c. For V_{IN} outside this range consult typical EN threshold curve.
- d. Not tested, guaranteed by design.
- e. Not tested, guaranteed by correlation test with $10\ \Omega$, $0.1\ \mu\text{F}$ load.

TIMMING WAVEFORMS

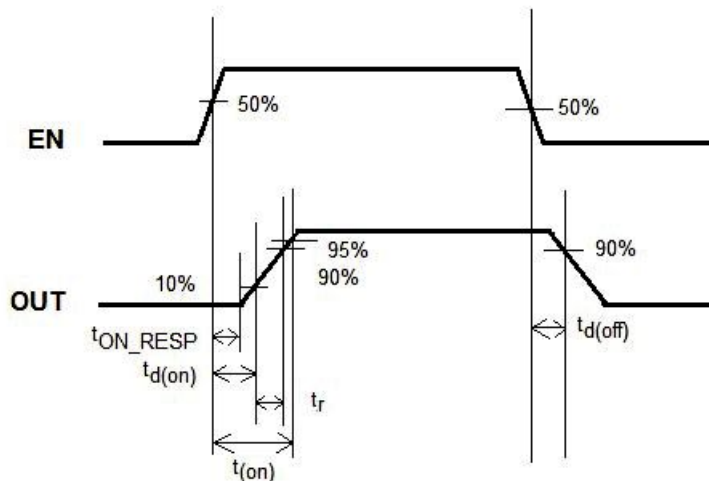

Figure 2 -

PIN CONFIGURATION

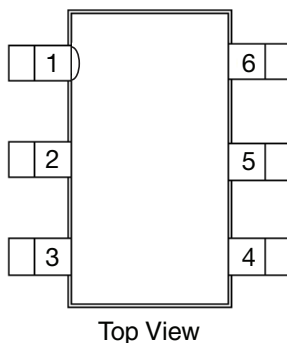

Figure 3 - TSOT23-6 Package

PIN DESCRIPTION		
Pin Number	Name	Function
1, 2	OUT	These are output pins of the switch
3	EN	Enable input
4	GND	Ground connection
5, 6	IN	These are input pins of the switch

BLOCK DIAGRAM

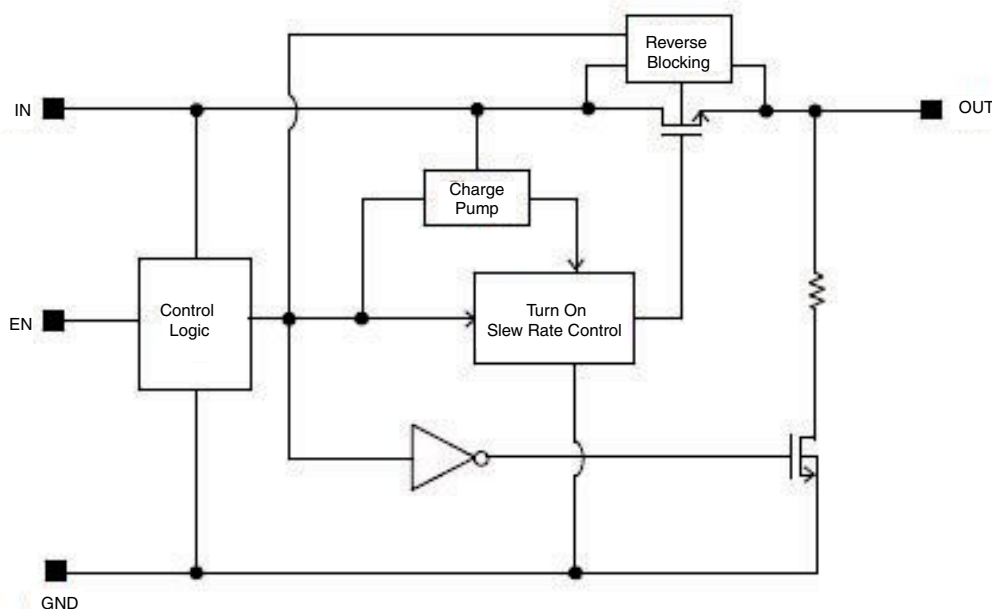

Figure 4 - Functional Block Diagram

TYPICAL CHARACTERISTICS (internally regulated, 25 °C, unless otherwise noted)

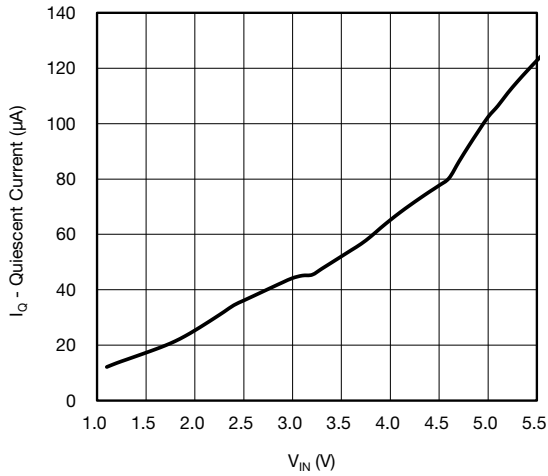

Figure 5 - Quiescent Current vs. Input Voltage

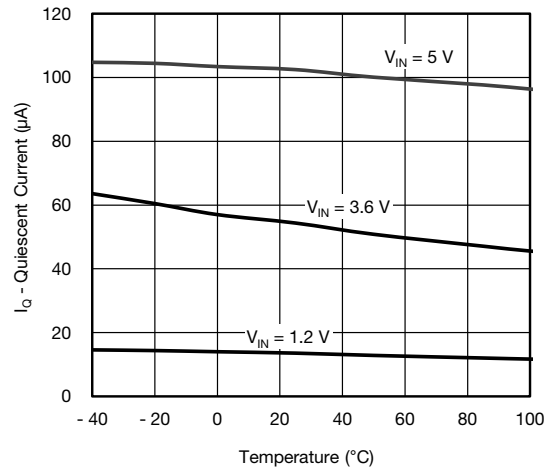

Figure 8 - Quiescent Current vs. Temperature

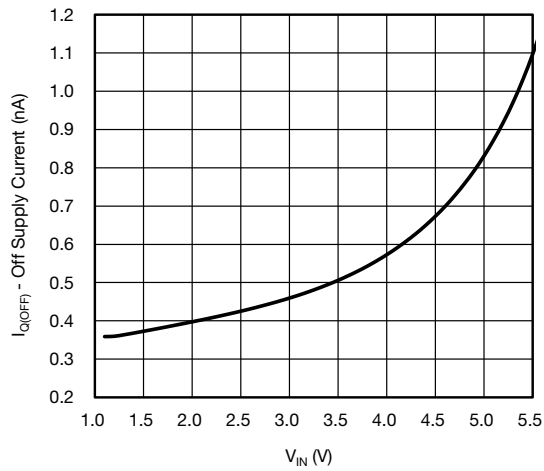

Figure 6 - Off Supply Current vs. Input Voltage

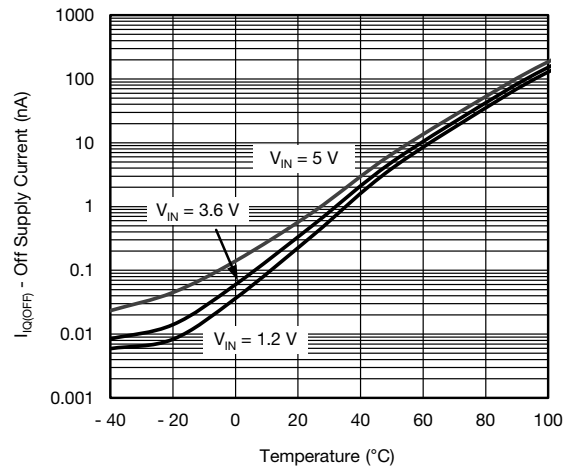

Figure 9 - Off Supply Current vs. Temperature

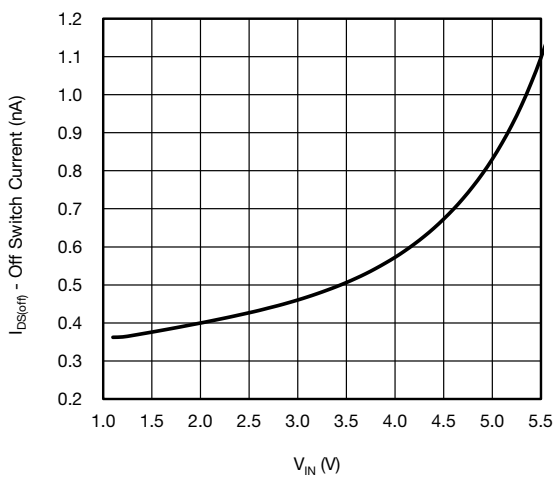

Figure 7 - Off Switch Current vs. Input Voltage

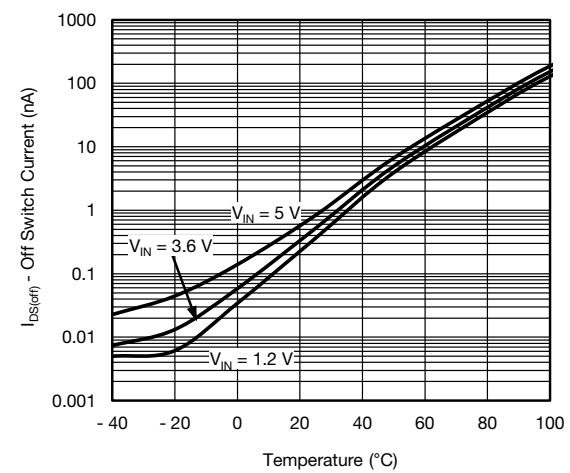

Figure 10 - Off Switch Current vs. Temperature

TYPICAL CHARACTERISTICS (internally regulated, 25 °C, unless otherwise noted)

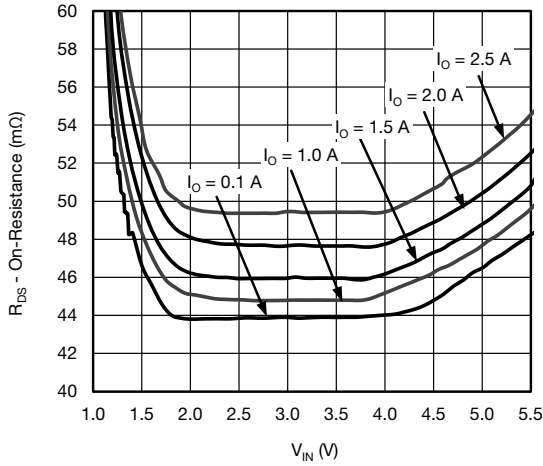

Figure 11 - On-Resistance vs. Input Voltage

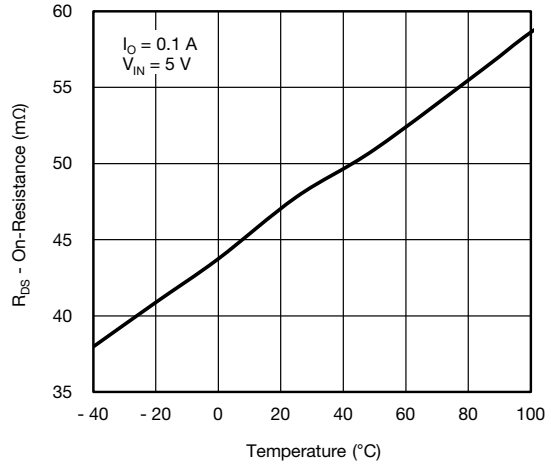

Figure 13 - On-Resistance vs. Temperature

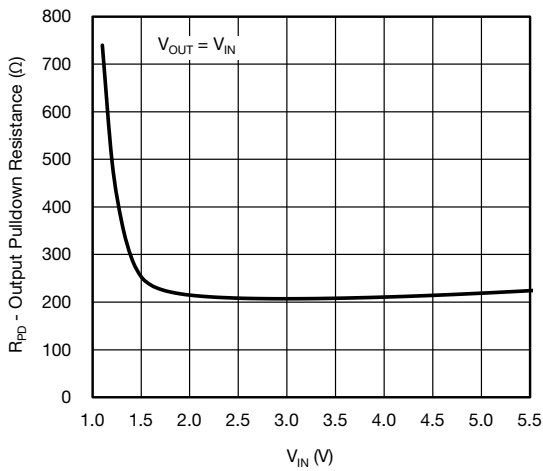

Figure 12 - Output Pulldown Resistance vs. Input Voltage

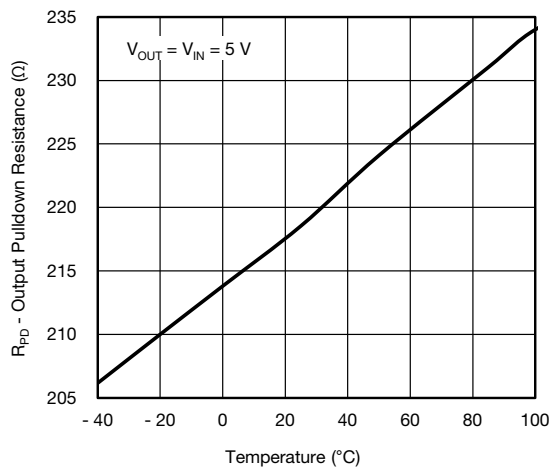

Figure 14 - Output Pulldown Resistance vs. Temperature

TYPICAL CHARACTERISTICS (internally regulated, 25 °C, unless otherwise noted)

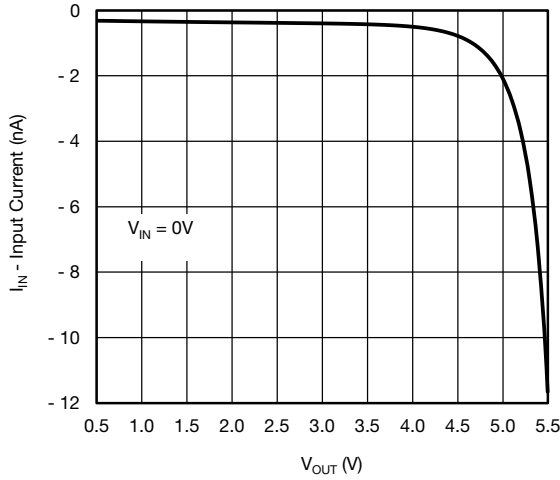

Figure 15 - Reverse Blocking Current vs. Output Voltage

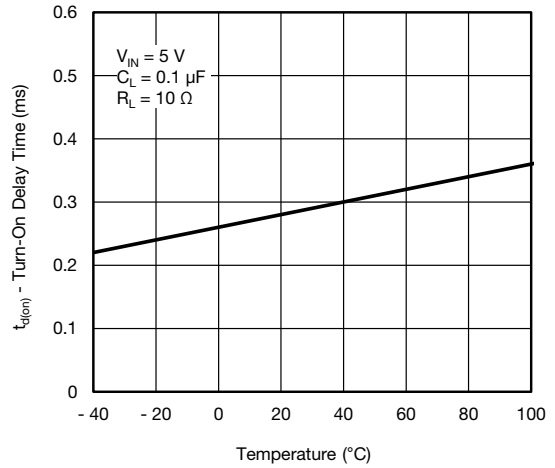

Figure 17 - Turn-On Delay Time vs. Temperature

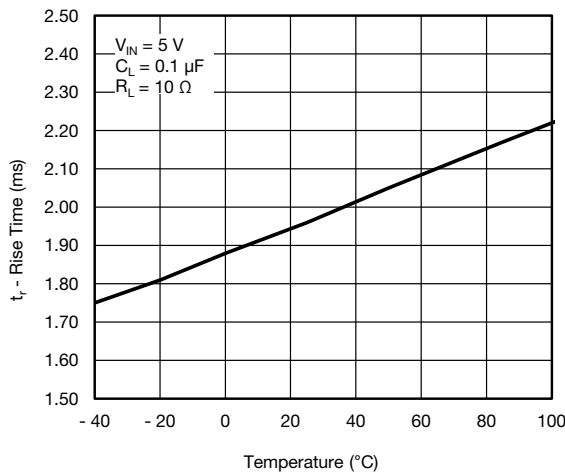

Figure 16 - Rise Time vs. Temperature

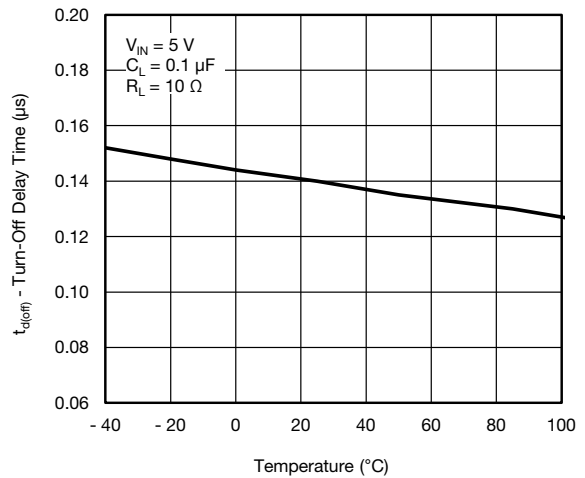

Figure 18 - Turn-Off Delay Time vs. Temperature

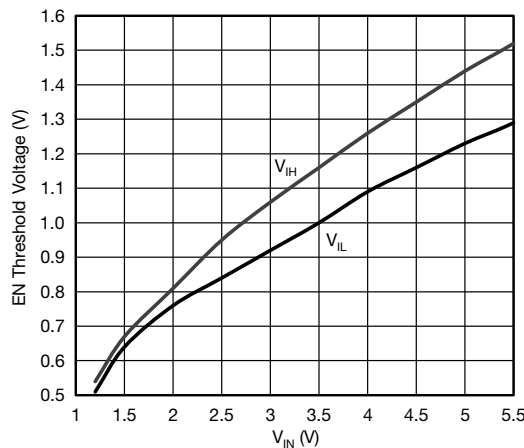

Figure 19 - EN Threshold Voltage vs. Input Voltage

TYPICAL WAVEFORMS

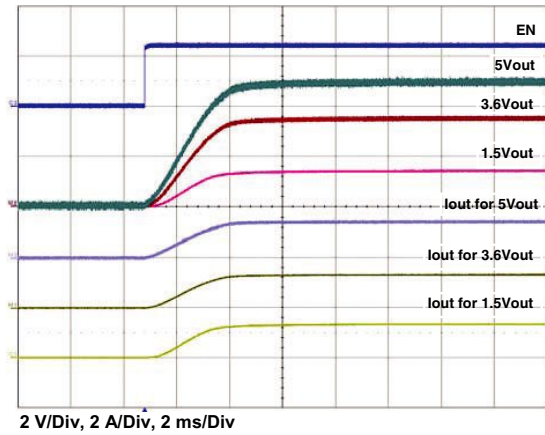

Figure 20 - Typical Turn-on Delay, Rise Time
 $C_{OUT} = 0.1 \mu F, C_{IN} = 4.7 \mu F, I_{OUT} = 1.5 A$

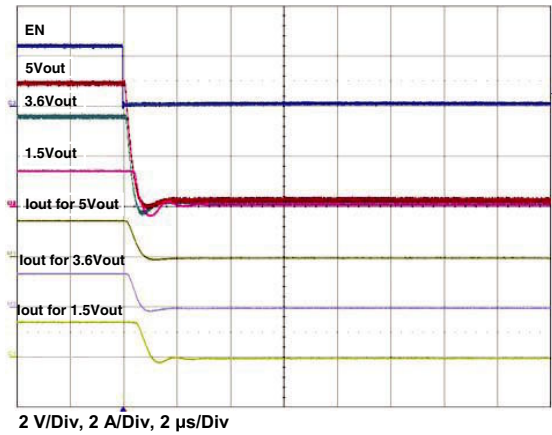

Figure 23 - Typical Fall Time
 $C_{OUT} = 0.1 \mu F, C_{IN} = 4.7 \mu F, I_{OUT} = 1.5 A$

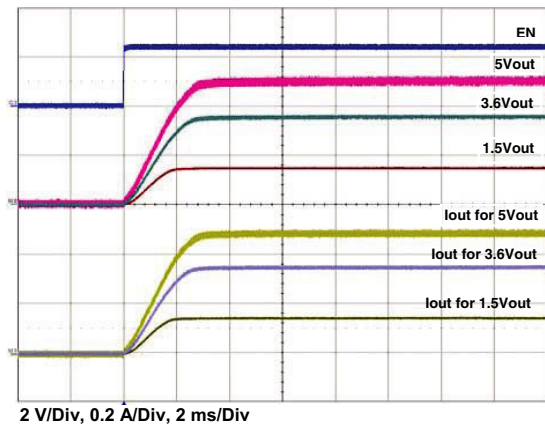

Figure 21 - Typical Turn-on Delay, Rise Time
 $C_{OUT} = 0.1 \mu F, C_{IN} = 4.7 \mu F, R_{OUT} = 10 \Omega$

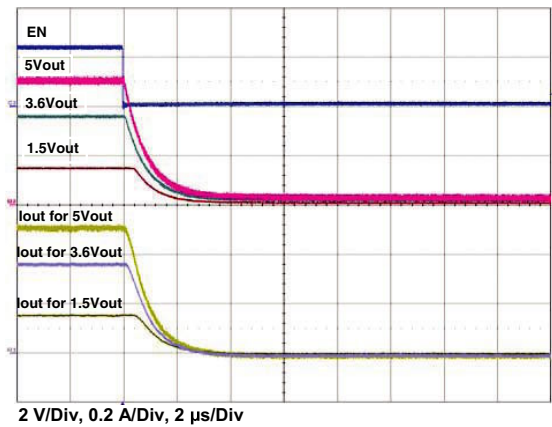

Figure 24 - Typical Fall Time
 $C_{OUT} = 0.1 \mu F, C_{IN} = 4.7 \mu F, R_{OUT} = 10 \Omega$

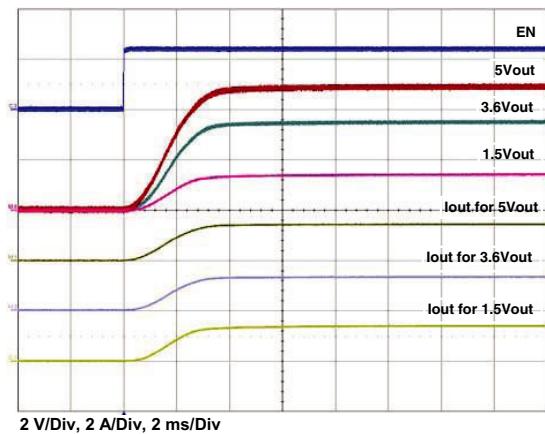

Figure 22 - Typical Turn-on Delay, Rise Time
 $C_{OUT} = 200 \mu F, C_{IN} = 4.7 \mu F, I_{OUT} = 1.5 A$

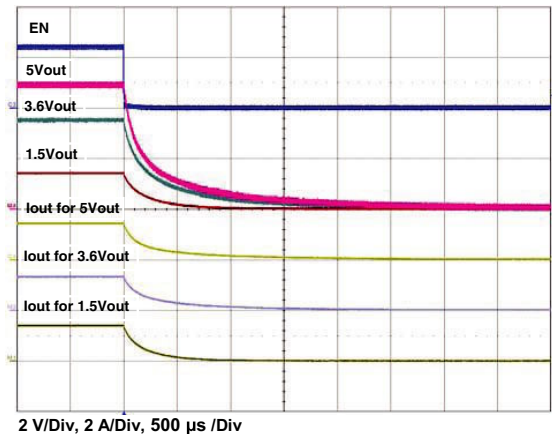

Figure 25 - Typical Fall Time
 $C_{OUT} = 200 \mu F, C_{IN} = 4.7 \mu F, I_{OUT} = 1.5 A$

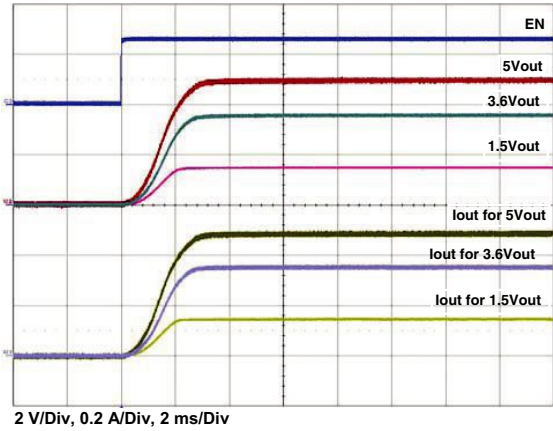

Figure 26 - Typical Turn-on Delay, Rise Time
 $C_{OUT} = 200 \mu F, C_{IN} = 4.7 \mu F, R_{OUT} = 10 \Omega$

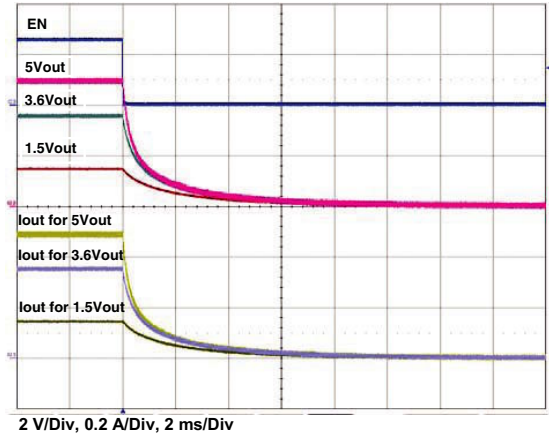

Figure 29 - Typical Fall Time
 $C_{OUT} = 200 \mu F, C_{IN} = 4.7 \mu F, R_{OUT} = 10 \Omega$

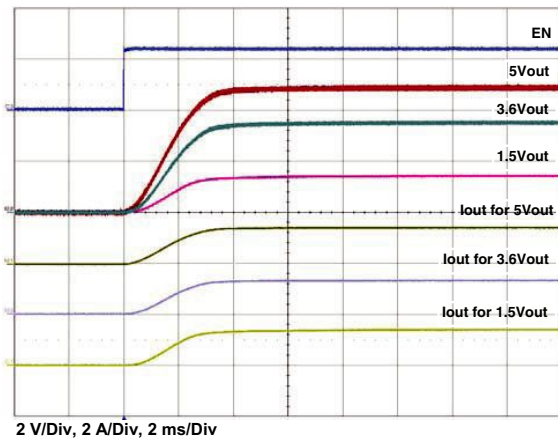

Figure 27 - Typical Turn-on Delay, Rise Time
 $C_{OUT} = 100 \mu F, C_{IN} = 4.7 \mu F, I_{OUT} = 1.5 A$

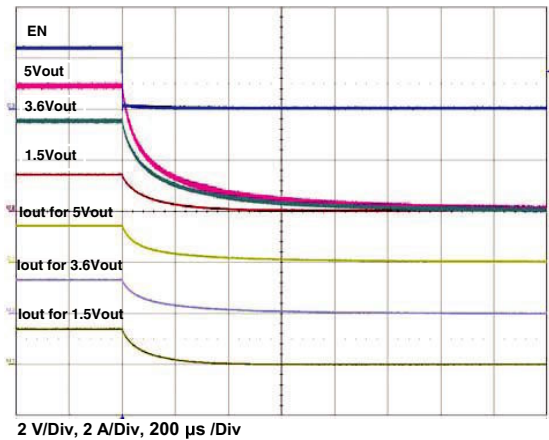

Figure 30 - Typical Fall Time
 $C_{OUT} = 100 \mu F, C_{IN} = 4.7 \mu F, I_{OUT} = 1.5 A$

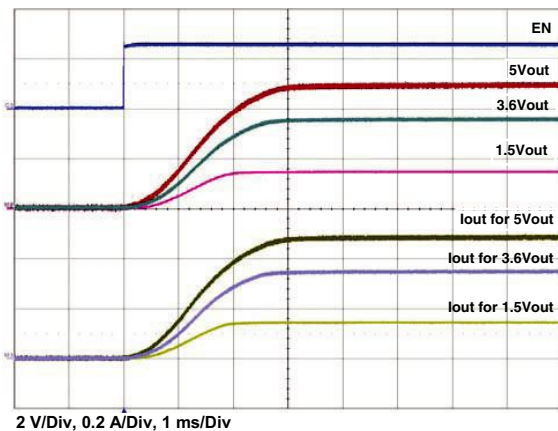

Figure 28 - Typical Turn-on Delay, Rise Time
 $C_{OUT} = 100 \mu F, C_{IN} = 4.7 \mu F, R_{OUT} = 10 \Omega$

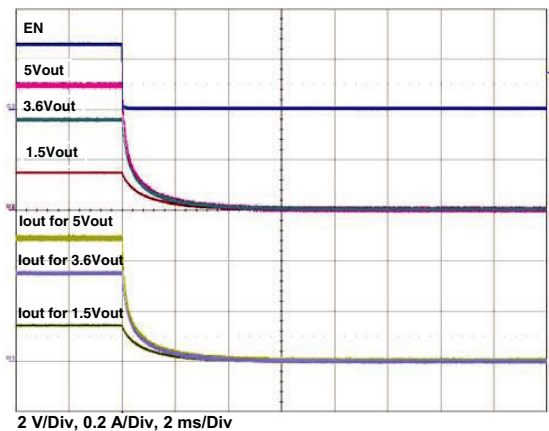

Figure 31 - Typical Turn-on Delay, Fall Time
 $C_{OUT} = 100 \mu F, C_{IN} = 4.7 \mu F, R_{OUT} = 10 \Omega$

DETAILED DESCRIPTION

SiP32510 is advanced slew rate controlled high side load switch consisted of a n-channel power switch. When the device is enable the gate of the power switch is turned on at a controlled rate to avoid excessive in-rush current. Once fully on the gate to source voltage of the power switch is biased at a constant level. The design gives a flat on resistance throughout the operating voltages. When the device is off, the reverse blocking circuitry prevents current from flowing back to input if output is raised higher than input. The reverse blocking mechanism also works in case of no input applied.

APPLICATION INFORMATION

Input Capacitor

SiP32510 does not require input capacitor. To limit the voltage drop on the input supply caused by transient inrush currents, a input bypass capacitor is recommended. A 2.2 μF ceramic capacitor placed as close to the V_{IN} and GND should be enough. Higher values capacitor can help to further reduce the voltage drop. Ceramic capacitors are recommended for their ability to withstand input current surge from low impedance sources such as batteries in portable devices.

Output Capacitor

While these devices work without an output capacitor, an 0.1 μF or larger capacitor across V_{OUT} and GND is recommended to accommodate load transient condition. It also helps preventing parasitic inductance from forcing V_{OUT} below GND when switching off. Output capacitor has minimal affect on device's turn on slew rate time. There is no requirement on capacitor type and its ESR.

Enable

The EN pin is compatible with both TTL and CMOS logic voltage levels. Enable pin voltage can be above IN once it is within the absolute maximum rating range.

Protection Against Reverse Voltage Condition

SiP32510 contains a reverse blocking circuitry to protect the current from going to the input from the output in case where the output voltage is higher than the input voltage when the main switch is off. Reverse blocking works for input voltage as low as 0 V.

Thermal Considerations

SiP32510 is designed to maintain a constant output load current. Due to physical limitations of the layout and assembly of the device the maximum switch current is 3 A, as stated in the Absolute Maximum Ratings table. However, another limiting characteristic for the safe operating load current is the thermal power dissipation of the package. To obtain the highest power dissipation (and a thermal resistance of 150 $^{\circ}\text{C}/\text{W}$) the IN and OUT pins of the device should be connected to heat sinks on the printed circuit board. All copper traces and vias for the IN and OUT pins should be sized adequately to carry the maximum continuous current.

The maximum power dissipation in any application is dependant on the maximum junction temperature, $T_{\text{J(max.)}} = 125^{\circ}\text{C}$, the junction-to-ambient thermal resistance for the TSOT23-6 package, $\theta_{\text{J-A}} = 150^{\circ}\text{C}/\text{W}$, and the ambient temperature, T_{A} , which may be formulaically expressed as:

$$P(\text{max.}) = \frac{T_{\text{J(max.)}} - T_{\text{A}}}{\theta_{\text{J-A}}} = \frac{125 - T_{\text{A}}}{150}$$

It then follows that, assuming an ambient temperature of 70 $^{\circ}\text{C}$, the maximum power dissipation will be limited to about 367 mW.

So long as the load current is below the 3 A limit, the maximum continuous switch current becomes a function of two things: the package power dissipation and the $R_{\text{DS(on)}}$ at the ambient temperature.

As an example let us calculate the worst case maximum load current at $T_{\text{A}} = 70^{\circ}\text{C}$ and 3.6 V input. The worst case $R_{\text{DS(on)}}$ at 25 $^{\circ}\text{C}$ and 3.6 V input is 52 m Ω . The $R_{\text{DS(on)}}$ at 70 $^{\circ}\text{C}$ can be extrapolated from this data using the following formula:

$$R_{\text{DS(on)}}(\text{at } 70^{\circ}\text{C}) = R_{\text{DS(on)}}(\text{at } 25^{\circ}\text{C}) \times (1 + T_{\text{C}} \times \Delta T)$$

Where T_{C} is 3570 ppm/ $^{\circ}\text{C}$. Continuing with the calculation we have

$$R_{\text{DS(on)}}(\text{at } 70^{\circ}\text{C}) = 52 \text{ m}\Omega \times (1 + 0.00357 \times (70^{\circ}\text{C} - 25^{\circ}\text{C})) = 60 \text{ m}\Omega$$

The maximum current limit is then determined by

$$I_{\text{LOAD}}(\text{max.}) < \sqrt{\frac{P(\text{max.})}{R_{\text{DS(ON)}}}}$$

which in this case is 2.4 A. Under the stated input voltage condition, if the 2.4 A current limit is exceeded the internal die temperature will rise and eventually, possibly damage the device.

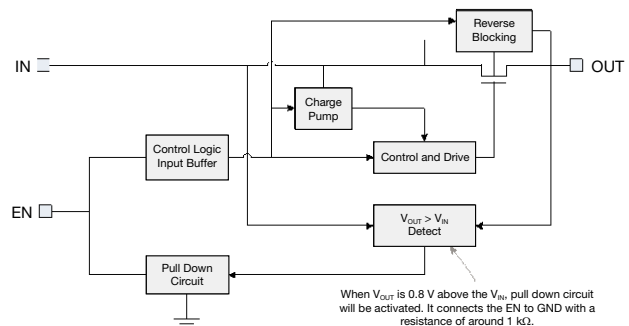

Active EN Pull Down for Reverse Blocking

When an internal circuit detects the condition of V_{OUT} 0.8 V higher than V_{IN} , it will turn on the pull down circuit connected to EN, forcing the switching OFF. The pull down value is about 1 k Ω .

Pulse Current Capability

The device is mounted on the evaluation board shown in the PCB layout section. It is loaded with pulses of 5 A and 1 ms for periods of 4.6 ms.

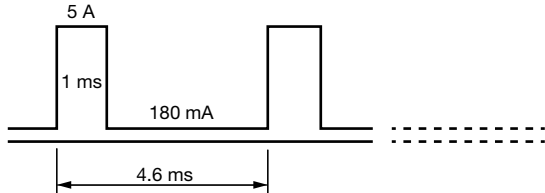

The SiP32510 can safely support 5 A pulse current repetitively at 25 °C.

Switch Non-Repetitive Pulsed Current

The SiP32510 can withstand inrush current of up to 12 A for 100 μs at 25 °C when heavy capacitive loads are connected and the part is already enabled.

Recommended Board Layout

For the best performance, all traces should be as short as possible to minimize the inductance and parasitic effects. The input and output capacitors should be kept as close as possible to the input and output pins respectively.

Connecting the central exposed pad to GND, using wide traces for input, output, and GND help reducing the case to ambient thermal impedance.

R_{DS(ON)} Measurement

As mentioned in the thermal consideration section, the R_{DS(ON)} is an important specification for the load switch. A proper method to measure the R_{DS(ON)} will ensure the proper calculation of the maximum operating power the SiP32510 load switch. The Kelvin connection directly to the input/output pin of the device is used to measure the dropout voltage of the SiP32510. By using the Kelvin connection to measure the dropout voltage will eliminate the measurement error due to the voltage drop caused by the forced power current. As illustrated in the following layout, J6 (OUT-S) is Kelvin connection to the output of SiP32510 and J5 (IN-S) is the Kelvin connection to the input of SiP32510. A current meter is used to measure the output current.

R_{DS(on)} is calculated by the following formula:

$$R_{DS(on)} = \frac{\text{Dropout Voltage}}{\text{Output Current}}$$

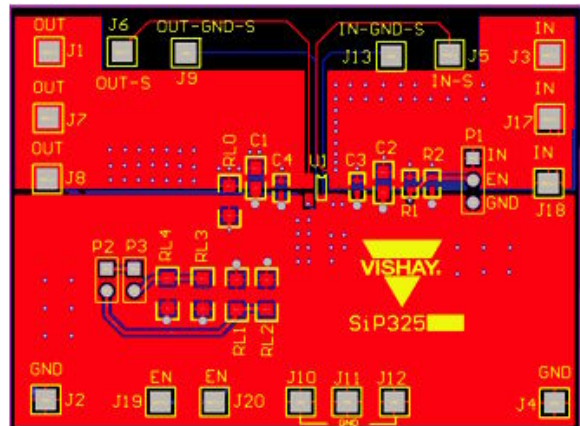

Figure 32 - Evaluation Board Layout for TSOT23-6L

Vishay Siliconix maintains worldwide manufacturing capability. Products may be manufactured at one of several qualified locations. Reliability data for Silicon Technology and Package Reliability represent a composite of all qualified locations. For related documents such as package/tape drawings, part marking, and reliability data, see www.vishay.com/ppg?63577.



Disclaimer

ALL PRODUCT, PRODUCT SPECIFICATIONS AND DATA ARE SUBJECT TO CHANGE WITHOUT NOTICE TO IMPROVE RELIABILITY, FUNCTION OR DESIGN OR OTHERWISE.

Vishay Intertechnology, Inc., its affiliates, agents, and employees, and all persons acting on its or their behalf (collectively, "Vishay"), disclaim any and all liability for any errors, inaccuracies or incompleteness contained in any datasheet or in any other disclosure relating to any product.

Vishay makes no warranty, representation or guarantee regarding the suitability of the products for any particular purpose or the continuing production of any product. To the maximum extent permitted by applicable law, Vishay disclaims (i) any and all liability arising out of the application or use of any product, (ii) any and all liability, including without limitation special, consequential or incidental damages, and (iii) any and all implied warranties, including warranties of fitness for particular purpose, non-infringement and merchantability.

Statements regarding the suitability of products for certain types of applications are based on Vishay's knowledge of typical requirements that are often placed on Vishay products in generic applications. Such statements are not binding statements about the suitability of products for a particular application. It is the customer's responsibility to validate that a particular product with the properties described in the product specification is suitable for use in a particular application. Parameters provided in datasheets and / or specifications may vary in different applications and performance may vary over time. All operating parameters, including typical parameters, must be validated for each customer application by the customer's technical experts. Product specifications do not expand or otherwise modify Vishay's terms and conditions of purchase, including but not limited to the warranty expressed therein.

Except as expressly indicated in writing, Vishay products are not designed for use in medical, life-saving, or life-sustaining applications or for any other application in which the failure of the Vishay product could result in personal injury or death. Customers using or selling Vishay products not expressly indicated for use in such applications do so at their own risk. Please contact authorized Vishay personnel to obtain written terms and conditions regarding products designed for such applications.

No license, express or implied, by estoppel or otherwise, to any intellectual property rights is granted by this document or by any conduct of Vishay. Product names and markings noted herein may be trademarks of their respective owners.

Mouser Electronics

Authorized Distributor

Click to View Pricing, Inventory, Delivery & Lifecycle Information:

Vishay:

[SIP32510DT-T1-GE3](#)