



Automotive Dual N-Channel 40 V (D-S) 175 °C MOSFETs

PRODUCT SUMMARY		
	N-CHANNEL 1	N-CHANNEL 2
V _{DS} (V)	40	40
R _{DS(on)} (Ω) at V _{GS} = 10 V	0.0160	0.0064
R _{DS(on)} (Ω) at V _{GS} = 4.5 V	0.0188	0.0076
I _D (A)	15	18
Configuration	Dual N	

FEATURES

- TrenchFET® Power MOSFET
- AEC-Q101 Qualified^d
- 100 % R_g and UIS Tested
- Material categorization:
For definitions of compliance please see www.vishay.com/doc?99912

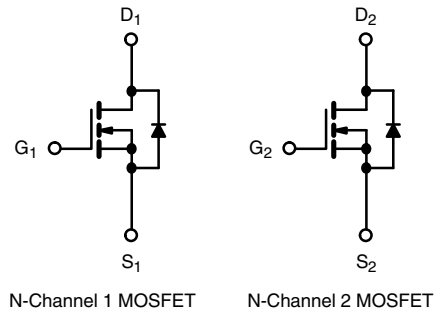
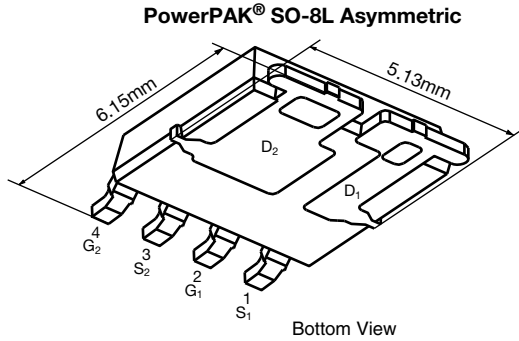

ORDERING INFORMATION	
Package	PowerPAK SO-8L Dual Asymmetric
Lead (Pb)-free and Halogen-free	SQJ940EP-T1-GE3

ABSOLUTE MAXIMUM RATINGS (T _C = 25 °C, unless otherwise noted)					
PARAMETER	SYMBOL	N-CHANNEL 1	N-CHANNEL 2	UNIT	
Drain-Source Voltage	V _{DS}	40	40	V	
Gate-Source Voltage	V _{GS}	± 20			
Continuous Drain Current ^a	I _D	T _C = 25 °C	15	18	A
		T _C = 125 °C	15	10.5	
Continuous Source Current (Diode Conduction) ^a	I _S	15	39		
Pulsed Drain Current ^b	I _{DM}	60	72		
Single Pulse Avalanche Current	I _{AS}	20.5	35.5		
Single Pulse Avalanche Energy	E _{AS}	21	63	mJ	
Maximum Power Dissipation ^b	P _D	T _C = 25 °C	48	43	W
		T _C = 125 °C	16	14	
Operating Junction and Storage Temperature Range	T _J , T _{stg}	- 55 to + 175		°C	
Soldering Recommendations (Peak Temperature) ^{e, f}		260			

THERMAL RESISTANCE RATINGS				
PARAMETER	SYMBOL	N-CHANNEL 1	N-CHANNEL 2	UNIT
Junction-to-Ambient	R _{thJA}	70	70	°C/W
Junction-to-Case (Drain)	R _{thJC}	3.3	3.5	

Notes

- Package limited.
- Pulse test; pulse width ≤ 300 μs, duty cycle ≤ 2 %.
- When mounted on 1" square PCB (FR4 material).
- Parametric verification ongoing.
- See solder profile (www.vishay.com/doc?73257). The PowerPAK SO-8L is a leadless package. The end of the lead terminal is exposed copper (not plated) as a result of the singulation process in manufacturing. A solder fillet at the exposed copper tip cannot be guaranteed and is not required to ensure adequate bottom side solder interconnection.
- Rework conditions: manual soldering with a soldering iron is not recommended for leadless components.



SPECIFICATIONS ($T_C = 25\text{ }^\circ\text{C}$, unless otherwise noted)								
PARAMETER	SYMBOL	TEST CONDITIONS			MIN.	TYP.	MAX.	UNIT
Static								
Drain-Source Breakdown Voltage	V_{DS}	$V_{GS} = 0\text{ V}, I_D = 250\text{ }\mu\text{A}$		N-Ch 1	40	-	-	V
		$V_{GS} = 0\text{ V}, I_D = 250\text{ }\mu\text{A}$		N-Ch 2	40	-	-	
Gate-Source Threshold Voltage	$V_{GS(th)}$	$V_{DS} = V_{GS}, I_D = 250\text{ }\mu\text{A}$		N-Ch 1	1.5	2	2.5	V
		$V_{DS} = V_{GS}, I_D = 250\text{ }\mu\text{A}$		N-Ch 2	1.5	2	2.5	
Gate-Source Leakage	I_{GSS}	$V_{DS} = 0\text{ V}, V_{GS} = \pm 20\text{ V}$		N-Ch 1	-	-	± 100	nA
				N-Ch 2	-	-	± 100	
Zero Gate Voltage Drain Current	I_{DSS}	$V_{GS} = 0\text{ V}$	$V_{DS} = 40\text{ V}$	N-Ch 1	-	-	1	μA
		$V_{GS} = 0\text{ V}$	$V_{DS} = -40\text{ V}$	N-Ch 2	-	-	1	
		$V_{GS} = 0\text{ V}$	$V_{DS} = 40\text{ V}, T_J = 125\text{ }^\circ\text{C}$	N-Ch 1	-	-	50	
		$V_{GS} = 0\text{ V}$	$V_{DS} = 40\text{ V}, T_J = 125\text{ }^\circ\text{C}$	N-Ch 2	-	-	50	
		$V_{GS} = 0\text{ V}$	$V_{DS} = 40\text{ V}, T_J = 175\text{ }^\circ\text{C}$	N-Ch 1	-	-	150	
		$V_{GS} = 0\text{ V}$	$V_{DS} = 40\text{ V}, T_J = 175\text{ }^\circ\text{C}$	N-Ch 2	-	-	150	
On-State Drain Current ^a	$I_{D(on)}$	$V_{GS} = 10\text{ V}$	$V_{DS} \geq 5\text{ V}$	N-Ch 1	30	-	-	A
		$V_{GS} = 10\text{ V}$	$V_{DS} \geq 5\text{ V}$	N-Ch 2	30	-	-	
Drain-Source On-State Resistance ^a	$R_{DS(on)}$	$V_{GS} = 10\text{ V}$	$I_D = 15\text{ A}$	N-Ch 1	-	0.0133	0.0160	Ω
		$V_{GS} = 10\text{ V}$	$I_D = 20\text{ A}$	N-Ch 2	-	0.0053	0.0064	
		$V_{GS} = 10\text{ V}$	$I_D = 15\text{ A}, T_J = 125\text{ }^\circ\text{C}$	N-Ch 1	-	-	0.0270	
		$V_{GS} = 10\text{ V}$	$I_D = 20\text{ A}, T_J = 125\text{ }^\circ\text{C}$	N-Ch 2	-	-	0.0105	
		$V_{GS} = 10\text{ V}$	$I_D = 15\text{ A}, T_J = 175\text{ }^\circ\text{C}$	N-Ch 1	-	-	0.0334	
		$V_{GS} = 10\text{ V}$	$I_D = 20\text{ A}, T_J = 175\text{ }^\circ\text{C}$	N-Ch 2	-	-	0.0130	
		$V_{GS} = 4.5\text{ V}$	$I_D = 13\text{ A}$	N-Ch 1	-	0.0157	0.0188	
		$V_{GS} = 4.5\text{ V}$	$I_D = 18\text{ A}$	N-Ch 2	-	0.0063	0.0076	
Forward Transconductance ^b	g_{fs}	$V_{DS} = 15\text{ V}, I_D = 15\text{ A}$		N-Ch 1	-	64	-	S
		$V_{DS} = 15\text{ V}, I_D = 20\text{ A}$		N-Ch 2	-	102	-	
Dynamic^b								
Input Capacitance	C_{iss}	$V_{GS} = 0\text{ V}$	$V_{DS} = 20\text{ V}, f = 1\text{ MHz}$	N-Ch 1	-	717	896	pF
		$V_{GS} = 0\text{ V}$	$V_{DS} = 20\text{ V}, f = 1\text{ MHz}$	N-Ch 2	-	1850	2313	
Output Capacitance	C_{oss}	$V_{GS} = 0\text{ V}$	$V_{DS} = 20\text{ V}, f = 1\text{ MHz}$	N-Ch 1	-	118	148	pF
		$V_{GS} = 0\text{ V}$	$V_{DS} = 20\text{ V}, f = 1\text{ MHz}$	N-Ch 2	-	272	340	
Reverse Transfer Capacitance	C_{rss}	$V_{GS} = 0\text{ V}$	$V_{DS} = 20\text{ V}, f = 1\text{ MHz}$	N-Ch 1	-	48	60	pF
		$V_{GS} = 0\text{ V}$	$V_{DS} = 20\text{ V}, f = 1\text{ MHz}$	N-Ch 2	-	98	123	
Total Gate Charge ^c	Q_g	$V_{GS} = 10\text{ V}$	$V_{DS} = 20\text{ V}, I_D = 6\text{ A}$	N-Ch 1	-	13.5	20	nC
		$V_{GS} = 10\text{ V}$	$V_{DS} = 20\text{ V}, I_D = 16\text{ A}$	N-Ch 2	-	31.8	48	
Gate-Source Charge ^c	Q_{gs}	$V_{GS} = 10\text{ V}$	$V_{DS} = 20\text{ V}, I_D = 6\text{ A}$	N-Ch 1	-	2.24	-	nC
		$V_{GS} = 10\text{ V}$	$V_{DS} = 20\text{ V}, I_D = 16\text{ A}$	N-Ch 2	-	5.5	-	
Gate-Drain Charge ^c	Q_{gd}	$V_{GS} = 10\text{ V}$	$V_{DS} = 20\text{ V}, I_D = 6\text{ A}$	N-Ch 1	-	2.06	-	nC
		$V_{GS} = 10\text{ V}$	$V_{DS} = 20\text{ V}, I_D = 16\text{ A}$	N-Ch 2	-	4.7	-	
Gate Resistance	R_g	$f = 1\text{ MHz}$		N-Ch 1	1.2	2.52	5	Ω
				N-Ch 2	3	7.93	13	

Notes

- a. Pulse test; pulse width $\leq 300\text{ }\mu\text{s}$, duty cycle $\leq 2\%$.
- b. Guaranteed by design, not subject to production testing.
- c. Independent of operating temperature.



SPECIFICATIONS ($T_C = 25\text{ }^\circ\text{C}$, unless otherwise noted)							
PARAMETER	SYMBOL	TEST CONDITIONS	MIN.	TYP.	MAX.	UNIT	
Turn-On Delay Time ^c	$t_{d(on)}$	$V_{DD} = 20\text{ V}$, $R_L = 20\text{ }\Omega$ $I_D \cong 1\text{ A}$, $V_{GEN} = 10\text{ V}$, $R_g = 1\text{ }\Omega$	N-Ch 1	-	4.8	7.2	ns
		$V_{DD} = 20\text{ V}$, $R_L = 20\text{ }\Omega$ $I_D \cong 1\text{ A}$, $V_{GEN} = 10\text{ V}$, $R_g = 1\text{ }\Omega$	N-Ch 2	-	7.7	11.6	
Rise Time ^c	t_r	$V_{DD} = 20\text{ V}$, $R_L = 20\text{ }\Omega$ $I_D \cong 1\text{ A}$, $V_{GEN} = 10\text{ V}$, $R_g = 1\text{ }\Omega$	N-Ch 1	-	9.3	14	
		$V_{DD} = 20\text{ V}$, $R_L = 20\text{ }\Omega$ $I_D \cong 1\text{ A}$, $V_{GEN} = 10\text{ V}$, $R_g = 1\text{ }\Omega$	N-Ch 2	-	9.5	14.3	
Turn-Off Delay Time ^c	$t_{d(off)}$	$V_{DD} = 20\text{ V}$, $R_L = 20\text{ }\Omega$ $I_D \cong 1\text{ A}$, $V_{GEN} = 10\text{ V}$, $R_g = 1\text{ }\Omega$	N-Ch 1	-	15.6	23.4	
		$V_{DD} = 20\text{ V}$, $R_L = 20\text{ }\Omega$ $I_D \cong 1\text{ A}$, $V_{GEN} = 10\text{ V}$, $R_g = 1\text{ }\Omega$	N-Ch 2	-	47	70	
Fall Time ^c	t_f	$V_{DD} = 20\text{ V}$, $R_L = 20\text{ }\Omega$ $I_D \cong 1\text{ A}$, $V_{GEN} = 10\text{ V}$, $R_g = 1\text{ }\Omega$	N-Ch 1	-	4.9	7.4	
		$V_{DD} = 20\text{ V}$, $R_L = 20\text{ }\Omega$ $I_D \cong 1\text{ A}$, $V_{GEN} = 10\text{ V}$, $R_g = 1\text{ }\Omega$	N-Ch 2	-	13.5	20.3	
Source-Drain Diode Ratings and Characteristics ^b							
Pulsed Current ^a	I_{SM}		N-Ch 1	-	-	60	A
			N-Ch 2	-	-	72	
Forward Voltage	V_{SD}	$I_F = 8\text{ A}$, $V_{GS} = 0\text{ V}$	N-Ch 1	-	0.8	1.2	V
		$I_F = 17\text{ A}$, $V_{GS} = 0\text{ V}$	N-Ch 2	-	0.8	1.2	

Notes

- Pulse test; pulse width $\leq 300\text{ }\mu\text{s}$, duty cycle $\leq 2\%$.
- Guaranteed by design, not subject to production testing.
- Independent of operating temperature.

Stresses beyond those listed under "Absolute Maximum Ratings" may cause permanent damage to the device. These are stress ratings only, and functional operation of the device at these or any other conditions beyond those indicated in the operational sections of the specifications is not implied. Exposure to absolute maximum rating conditions for extended periods may affect device reliability.



N-CHANNEL 1 TYPICAL CHARACTERISTICS ($T_A = 25\text{ }^\circ\text{C}$, unless otherwise noted)

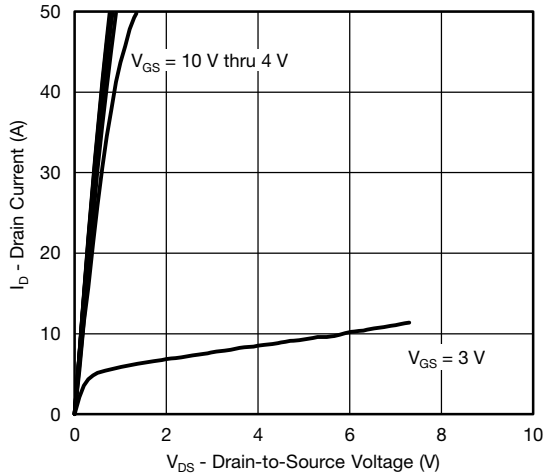

Output Characteristics

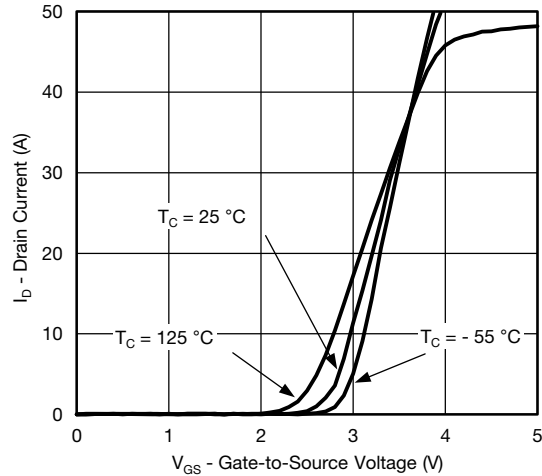

Transfer Characteristics

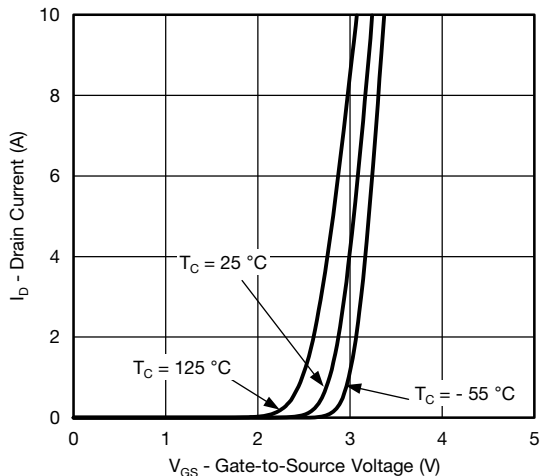

Transfer Characteristics

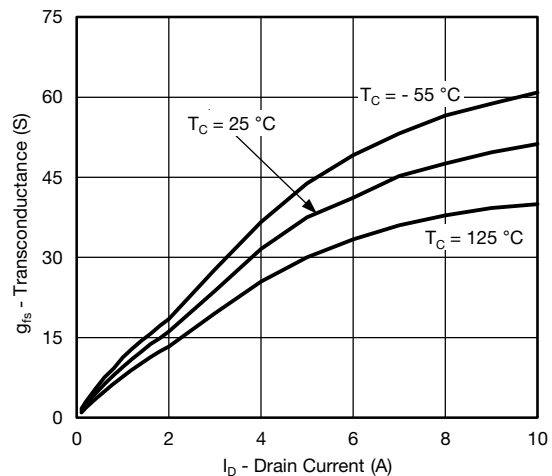

Transconductance

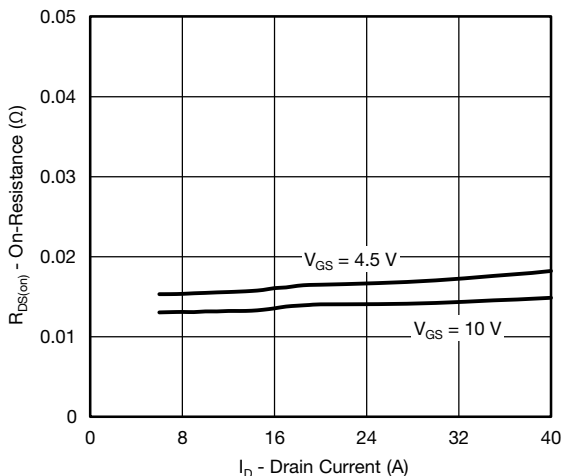

On-Resistance vs. Drain Current

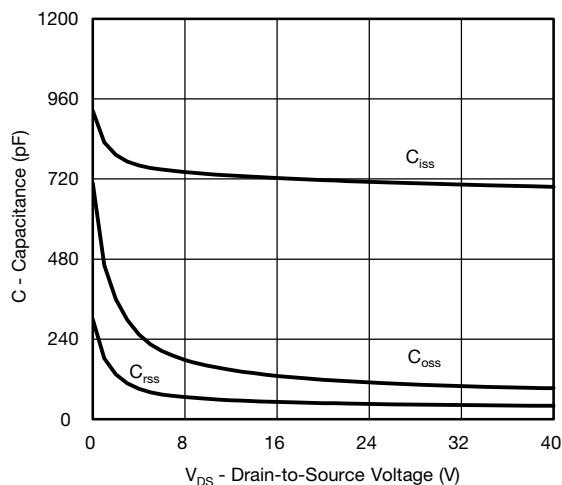

Capacitance



N-CHANNEL 1 TYPICAL CHARACTERISTICS ($T_A = 25\text{ }^\circ\text{C}$, unless otherwise noted)

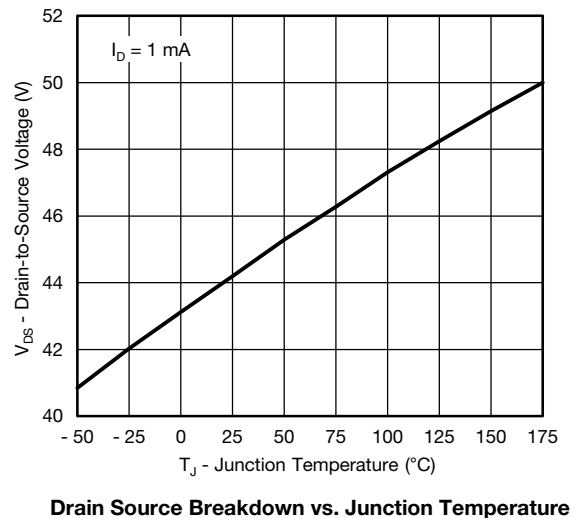
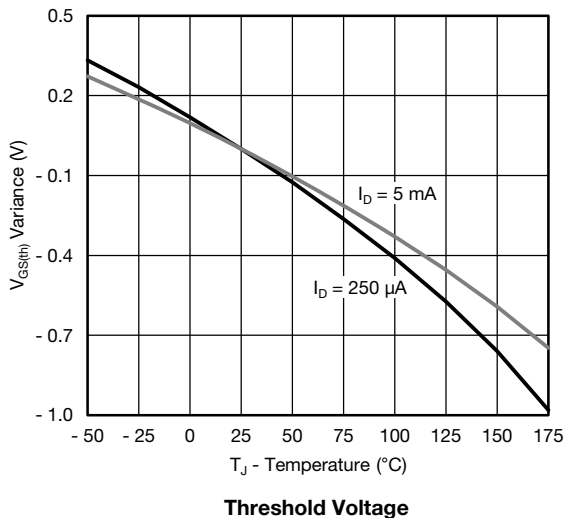
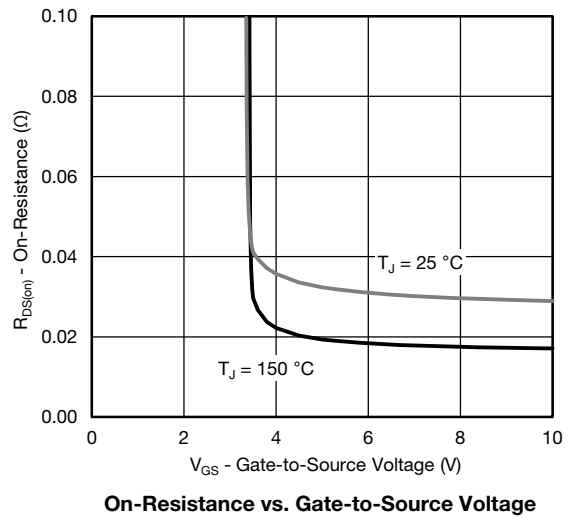
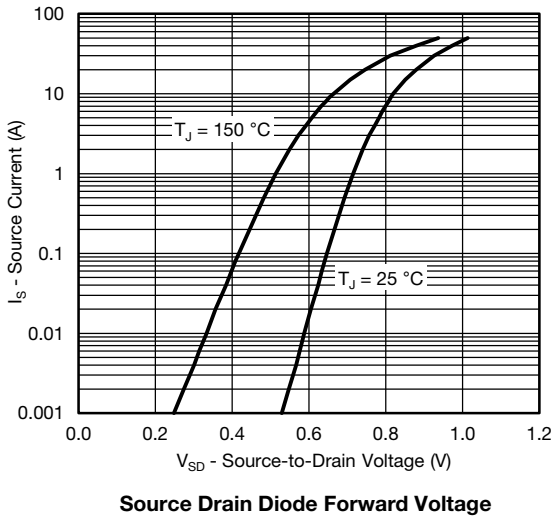
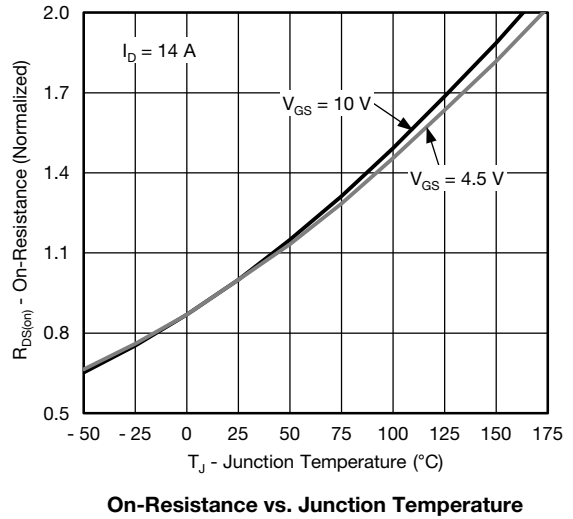
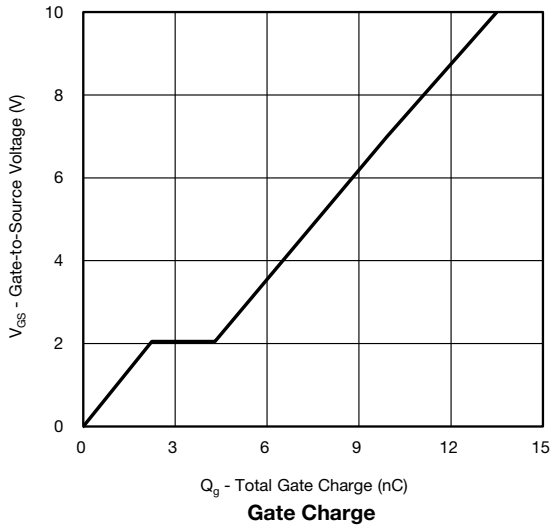



N-CHANNEL 1 TYPICAL CHARACTERISTICS ($T_A = 25\text{ }^\circ\text{C}$, unless otherwise noted)

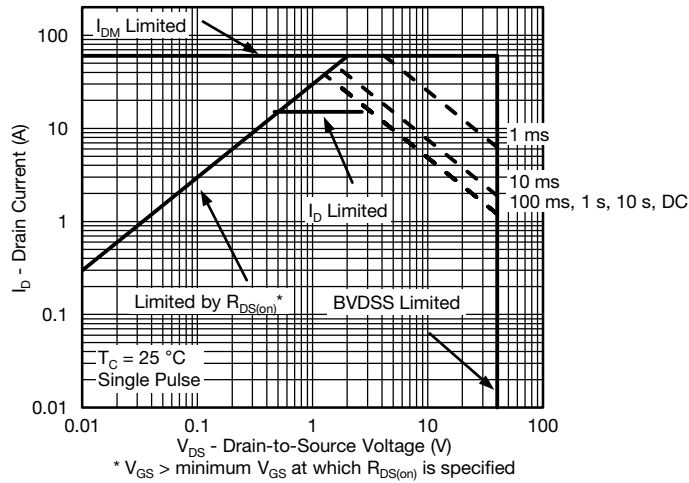

Safe Operating Area

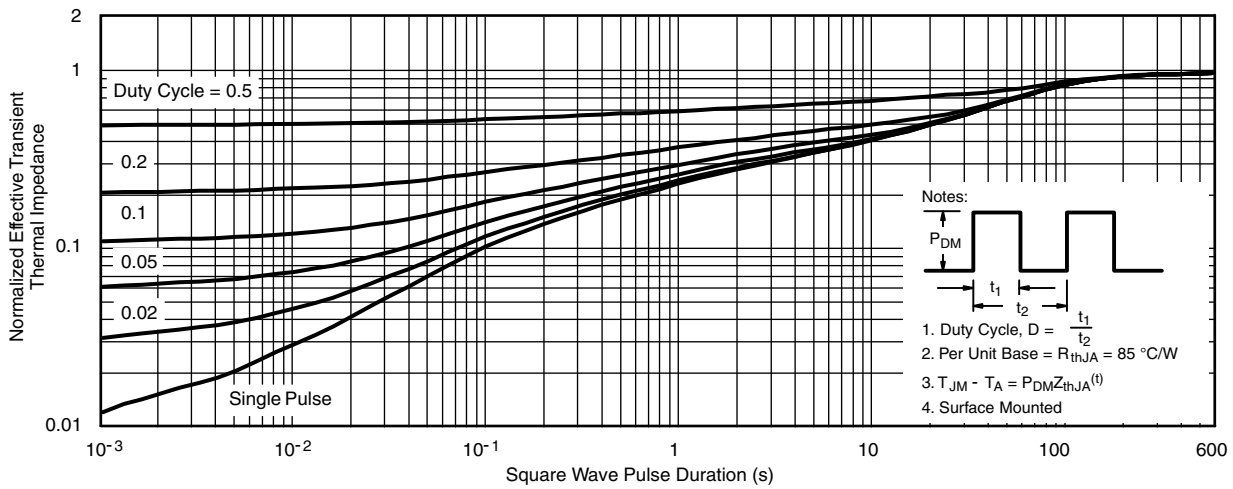

Normalized Thermal Transient Impedance, Junction-to-Ambient



N-CHANNEL 1 TYPICAL CHARACTERISTICS ($T_A = 25\text{ }^\circ\text{C}$, unless otherwise noted)

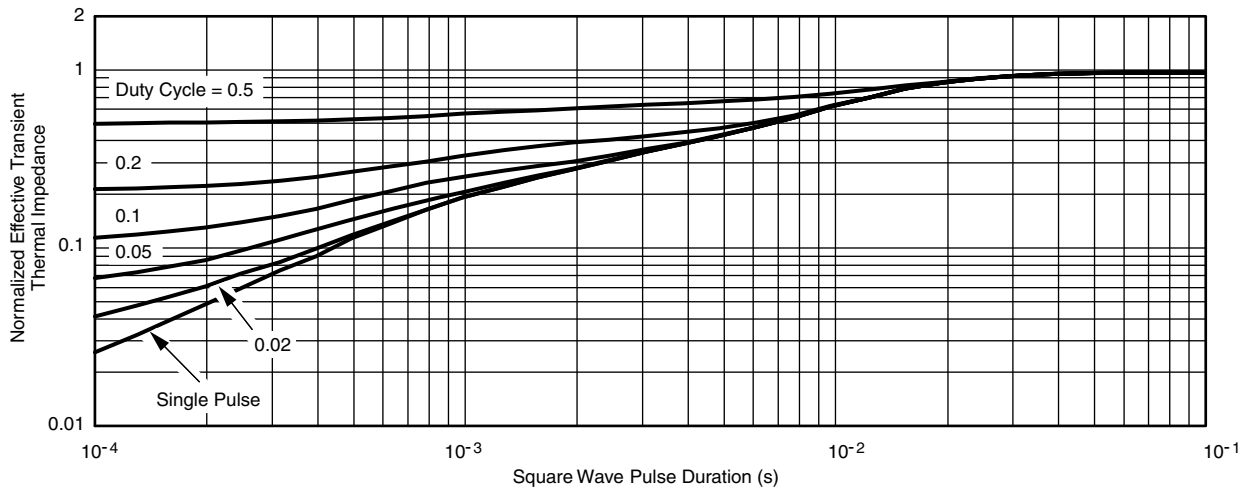

Normalized Thermal Transient Impedance, Junction-to-Case

Note

- The characteristics shown in the two graphs
 - Normalized Transient Thermal Impedance Junction-to-Ambient ($25\text{ }^\circ\text{C}$)
 - Normalized Transient Thermal Impedance Junction-to-Case ($25\text{ }^\circ\text{C}$)are given for general guidelines only to enable the user to get a “ball park” indication of part capabilities. The data are extracted from single pulse transient thermal impedance characteristics which are developed from empirical measurements. The latter is valid for the part mounted on printed circuit board - FR4, size 1" x 1" x 0.062", double sided with 2 oz. copper, 100 % on both sides. The part capabilities can widely vary depending on actual application parameters and operating conditions.



N-CHANNEL 2 TYPICAL CHARACTERISTICS ($T_A = 25\text{ }^\circ\text{C}$, unless otherwise noted)

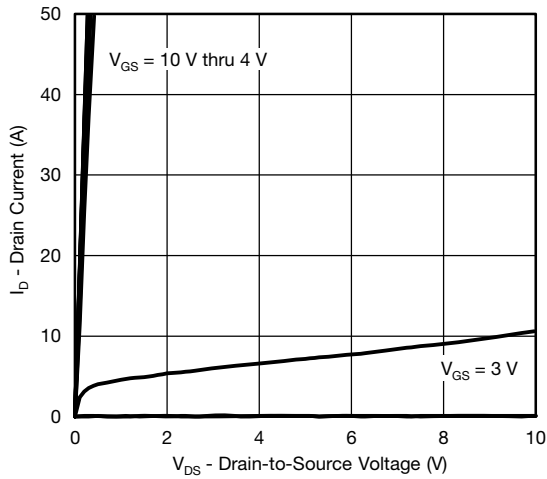

Output Characteristics

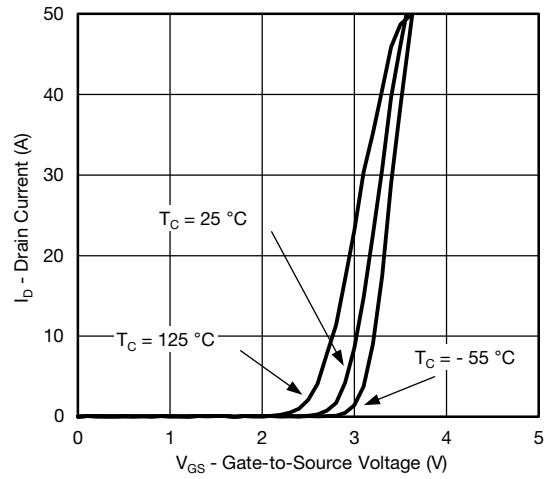

Transfer Characteristics

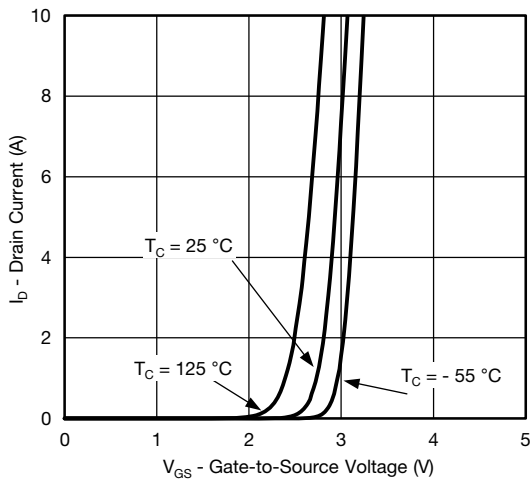

Transfer Characteristics

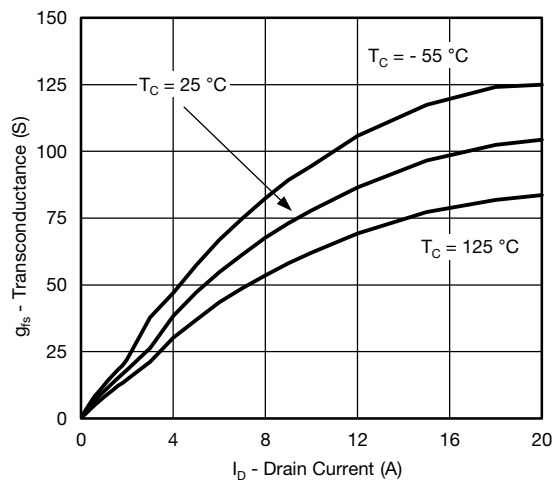

Transconductance

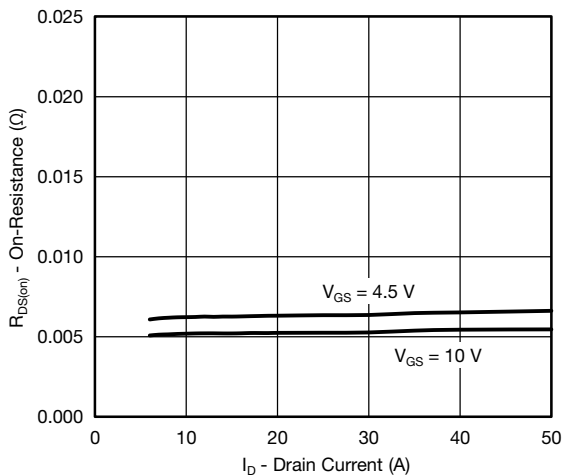

On-Resistance vs. Drain Current

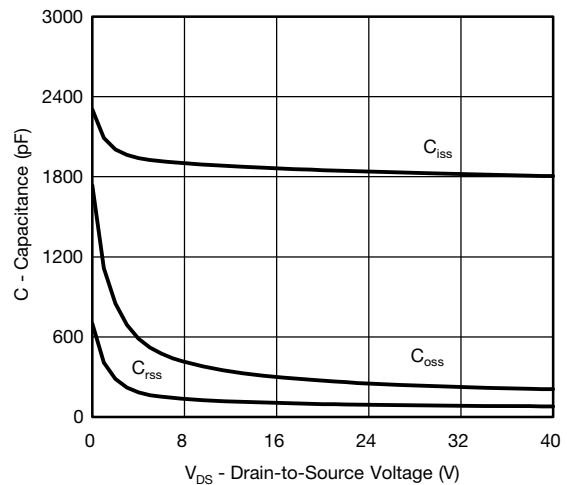

Capacitance



N-CHANNEL 2 TYPICAL CHARACTERISTICS ($T_A = 25\text{ }^\circ\text{C}$, unless otherwise noted)

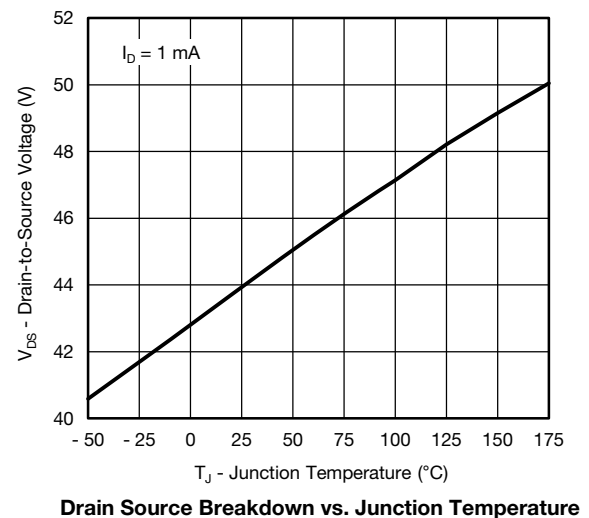
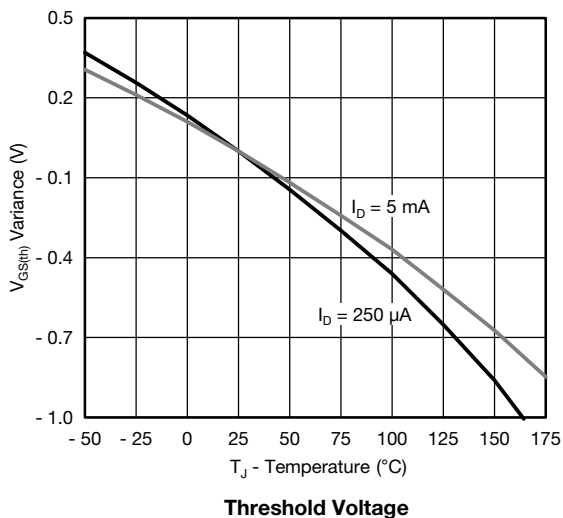
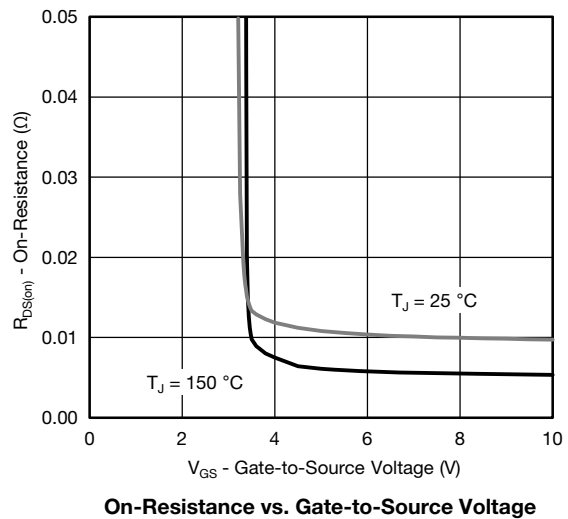
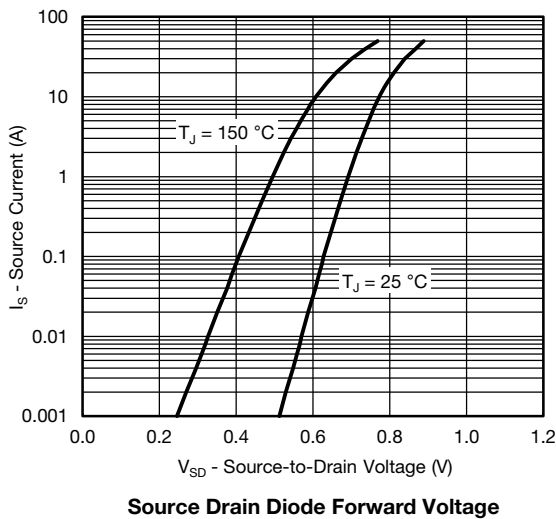
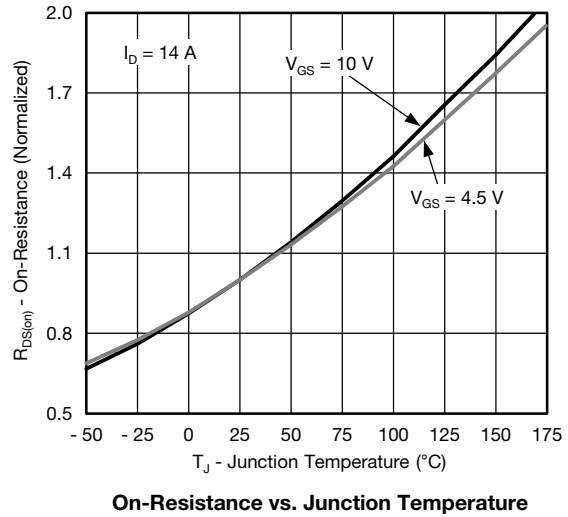
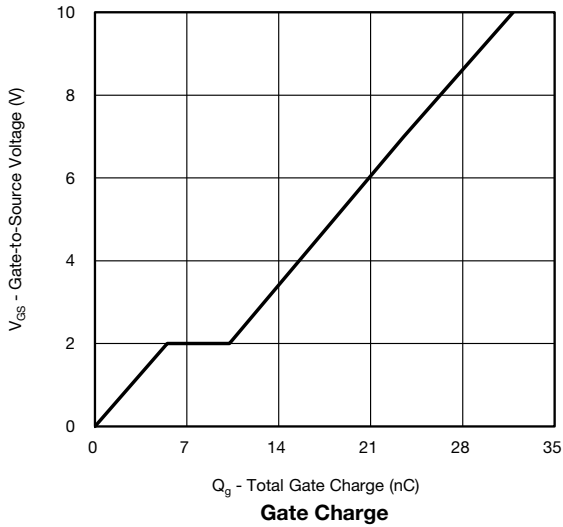

N-CHANNEL 2 TYPICAL CHARACTERISTICS ($T_A = 25\text{ }^\circ\text{C}$, unless otherwise noted)

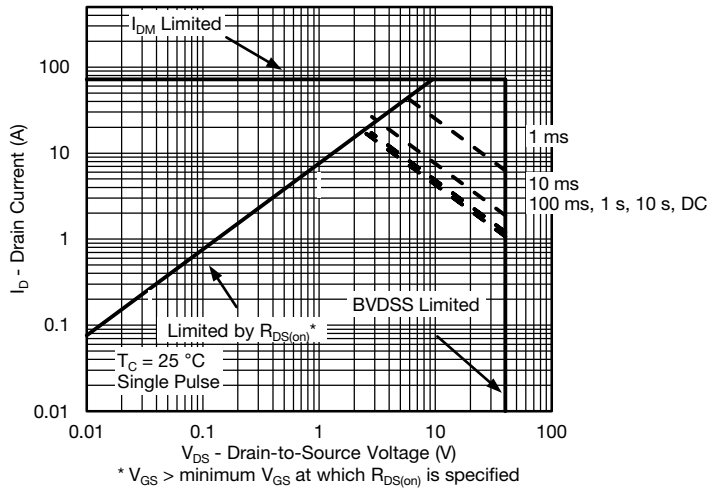

Safe Operating Area

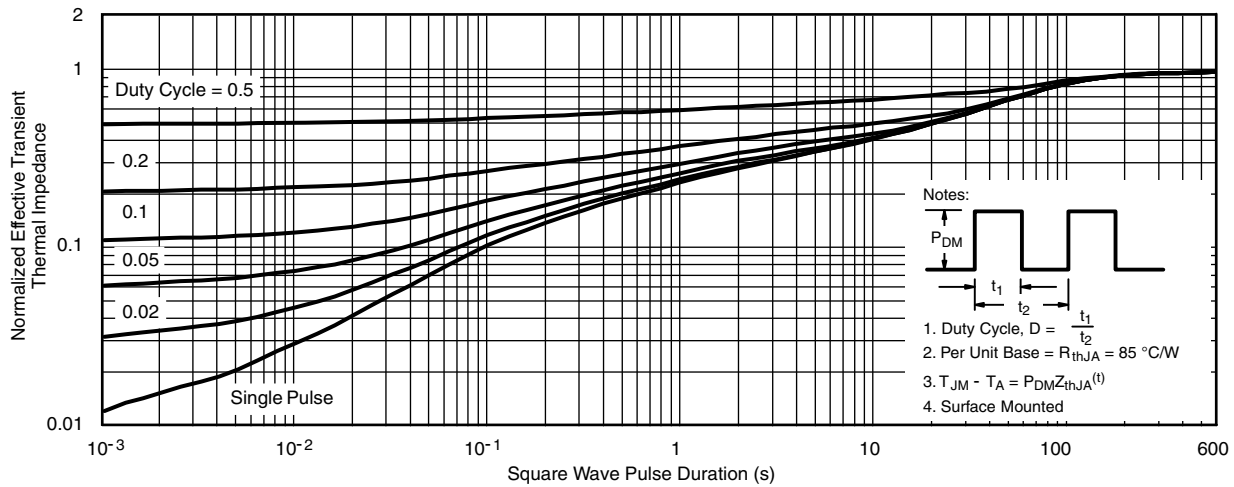

Normalized Thermal Transient Impedance, Junction-to-Ambient



N-CHANNEL 2 TYPICAL CHARACTERISTICS ($T_A = 25\text{ }^\circ\text{C}$, unless otherwise noted)

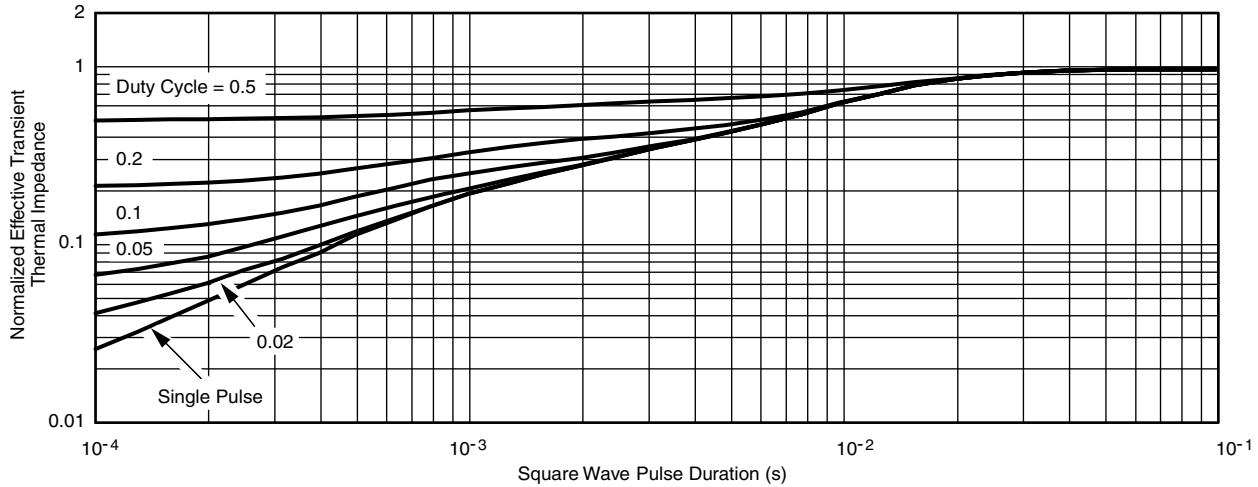

Normalized Thermal Transient Impedance, Junction-to-Case

Note

- The characteristics shown in the two graphs
 - Normalized Transient Thermal Impedance Junction-to-Ambient (25 °C)
 - Normalized Transient Thermal Impedance Junction-to-Case (25 °C)
 are given for general guidelines only to enable the user to get a “ball park” indication of part capabilities. The data are extracted from single pulse transient thermal impedance characteristics which are developed from empirical measurements. The latter is valid for the part mounted on printed circuit board - FR4, size 1" x 1" x 0.062", double sided with 2 oz. copper, 100 % on both sides. The part capabilities can widely vary depending on actual application parameters and operating conditions.

Vishay Siliconix maintains worldwide manufacturing capability. Products may be manufactured at one of several qualified locations. Reliability data for Silicon Technology and Package Reliability represent a composite of all qualified locations. For related documents such as package/tape drawings, part marking, and reliability data, see www.vishay.com/ppg?62767.



PowerPAK® SO-8L

Ordering codes for the SQ rugged series power MOSFETs in the PowerPAK SO-8L package:

DATASHEET PART NUMBER	OLD ORDERING CODE ^a	NEW ORDERING CODE
SQJ200EP	-	SQJ200EP-T1_GE3
SQJ202EP	-	SQJ202EP-T1_GE3
SQJ401EP	SQJ401EP-T1-GE3	SQJ401EP-T1_GE3
SQJ402EP	SQJ402EP-T1-GE3	SQJ402EP-T1_GE3
SQJ403EEP	SQJ403EEP-T1-GE3	SQJ403EEP-T1_GE3
SQJ403EP	-	SQJ403EP-T1_GE3
SQJ410EP	SQJ410EP-T1-GE3	SQJ410EP-T1_GE3
SQJ412EP	SQJ412EP-T1-GE3	SQJ412EP-T1_GE3
SQJ416EP	-	SQJ416EP-T1_GE3
SQJ418EP	-	SQJ418EP-T1_GE3
SQJ422EP	SQJ422EP-T1-GE3	SQJ422EP-T1_GE3
SQJ423EP	-	SQJ423EP-T1_GE3
SQJ431EP	SQJ431EP-T1-GE3	SQJ431EP-T1_GE3
SQJ443EP	SQJ443EP-T1-GE3	SQJ443EP-T1_GE3
SQJ444EP	-	SQJ444EP-T1_GE3
SQJ446EP	-	SQJ446EP-T1_GE3
SQJ456EP	SQJ456EP-T1-GE3	SQJ456EP-T1_GE3
SQJ457EP	-	SQJ457EP-T1_GE3
SQJ459EP	-	SQJ459EP-T1_GE3
SQJ460AEP	-	SQJ460AEP-T1_GE3
SQJ461EP	SQJ461EP-T1-GE3	SQJ461EP-T1_GE3
SQJ463EP	SQJ463EP-T1-GE3	SQJ463EP-T1_GE3
SQJ465EP	SQJ465EP-T1-GE3	SQJ465EP-T1_GE3
SQJ469EP	SQJ469EP-T1-GE3	SQJ469EP-T1_GE3
SQJ474EP	-	SQJ474EP-T1_GE3
SQJ476EP	-	SQJ476EP-T1_GE3
SQJ479EP	-	SQJ479EP-T1_GE3
SQJ486EP	SQJ486EP-T1-GE3	SQJ486EP-T1_GE3
SQJ488EP	SQJ488EP-T1-GE3	SQJ488EP-T1_GE3
SQJ500AEP	SQJ500AEP-T1-GE3	SQJ500AEP-T1_GE3
SQJ840EP	SQJ840EP-T1-GE3	SQJ840EP-T1_GE3
SQJ844AEP	SQJ844AEP-T1-GE3	SQJ844AEP-T1_GE3
SQJ850EP	SQJ850EP-T1-GE3	SQJ850EP-T1_GE3
SQJ858AEP	SQJ858AEP-T1-GE3	SQJ858AEP-T1_GE3
SQJ868EP	-	SQJ868EP-T1_GE3
SQJ886EP	SQJ886EP-T1-GE3	SQJ886EP-T1_GE3
SQJ910AEP	SQJ910AEP-T1-GE3	SQJ910AEP-T1_GE3
SQJ912AEP	SQJ912AEP-T1-GE3	SQJ912AEP-T1_GE3
SQJ940EP	SQJ940EP-T1-GE3	SQJ940EP-T1_GE3
SQJ942EP	SQJ942EP-T1-GE3	SQJ942EP-T1_GE3
SQJ951EP	SQJ951EP-T1-GE3	SQJ951EP-T1_GE3
SQJ952EP	-	SQJ952EP-T1_GE3
SQJ956EP	SQJ956EP-T1-GE3	SQJ956EP-T1_GE3
SQJ960EP	SQJ960EP-T1-GE3	SQJ960EP-T1_GE3
SQJ963EP	SQJ963EP-T1-GE3	SQJ963EP-T1_GE3
SQJ968EP	SQJ968EP-T1-GE3	SQJ968EP-T1_GE3
SQJ980AEP	SQJ980AEP-T1-GE3	SQJ980AEP-T1_GE3
SQJ992EP	SQJ992EP-T1-GE3	SQJ992EP-T1_GE3

Note

a. Old ordering code is obsolete and no longer valid for new orders

PowerPAK[®] SO-8L Assymmetric Case Outline

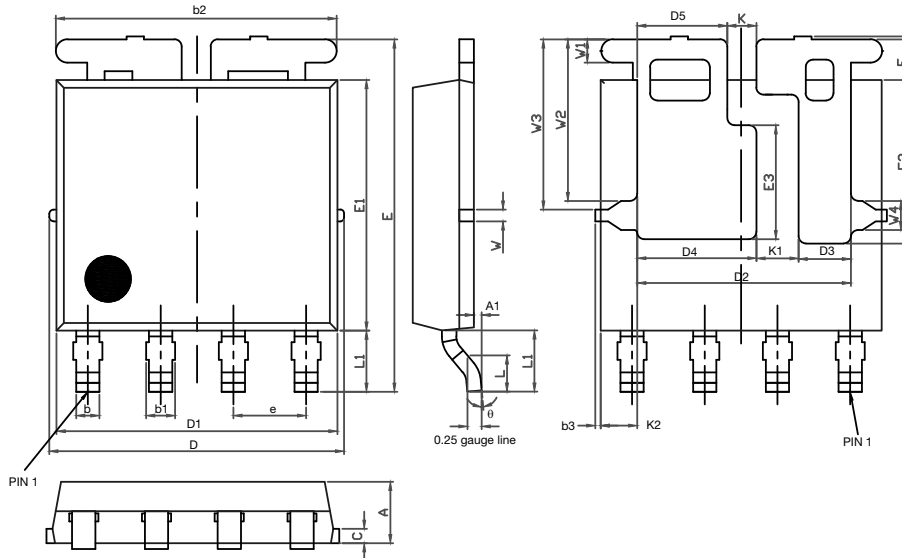

DIM.	MILLIMETERS			INCHES		
	MIN.	NOM.	MAX.	MIN.	NOM.	MAX.
A	1.00	1.07	1.14	0.039	0.042	0.045
A1	0.00	0.06	0.13	0.000	0.003	0.005
b	0.33	0.41	0.48	0.013	0.016	0.019
b1	0.44	0.51	0.58	0.017	0.020	0.023
b2	4.80	4.90	5.00	0.189	0.193	0.197
b3	0.04	0.12	0.20	0.002	0.005	0.008
c	0.20	0.25	0.30	0.008	0.010	0.012
D	5.00	5.13	5.25	0.197	0.202	0.207
D1	4.80	4.90	5.00	0.189	0.193	0.197
D2	3.63	3.73	3.83	0.143	0.147	0.151
D3	0.81	0.91	1.01	0.032	0.036	0.040
D4	1.98	2.08	2.18	0.078	0.082	0.086
D5	1.47	1.57	1.67	0.058	0.062	0.066
e	1.20	1.27	1.34	0.047	0.050	0.053
E	6.05	6.15	6.25	0.238	0.242	0.246
E1	4.27	4.37	4.47	0.168	0.172	0.176
E2	2.75	2.85	2.95	0.108	0.112	0.116
E3	1.89	1.99	2.09	0.074	0.078	0.082
F	0.05	0.12	0.19	0.002	0.005	0.007
L	0.62	0.72	0.82	0.024	0.028	0.032
L1	0.92	1.07	1.22	0.036	0.042	0.048
K	0.41	0.51	0.61	0.016	0.020	0.024
K1	0.64	0.74	0.84	0.025	0.029	0.033
K2	0.54	0.64	0.74	0.021	0.025	0.029
W	0.13	0.23	0.33	0.005	0.009	0.013
W1	0.31	0.41	0.51	0.012	0.016	0.020
W2	2.72	2.82	2.92	0.107	0.111	0.115
W3	2.86	2.96	3.06	0.113	0.117	0.120
W4	0.41	0.51	0.61	0.016	0.020	0.024
θ	5°	10°	12°	5°	10°	12°

DWG: 6009

Note

- Millimeters will govern



RECOMMENDED MINIMUM PADS FOR PowerPAK® SO-8L DUAL ASYMMETRIC

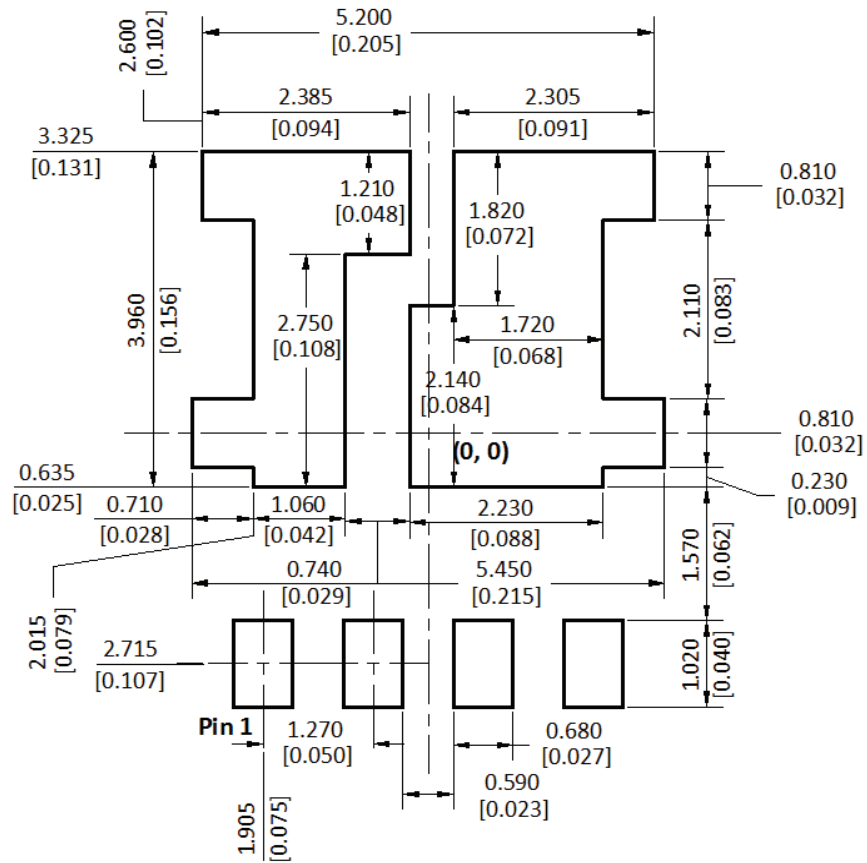

Recommended Minimum Pads
Dimensions in mm [inches]



Disclaimer

ALL PRODUCT, PRODUCT SPECIFICATIONS AND DATA ARE SUBJECT TO CHANGE WITHOUT NOTICE TO IMPROVE RELIABILITY, FUNCTION OR DESIGN OR OTHERWISE.

Vishay Intertechnology, Inc., its affiliates, agents, and employees, and all persons acting on its or their behalf (collectively, "Vishay"), disclaim any and all liability for any errors, inaccuracies or incompleteness contained in any datasheet or in any other disclosure relating to any product.

Vishay makes no warranty, representation or guarantee regarding the suitability of the products for any particular purpose or the continuing production of any product. To the maximum extent permitted by applicable law, Vishay disclaims (i) any and all liability arising out of the application or use of any product, (ii) any and all liability, including without limitation special, consequential or incidental damages, and (iii) any and all implied warranties, including warranties of fitness for particular purpose, non-infringement and merchantability.

Statements regarding the suitability of products for certain types of applications are based on Vishay's knowledge of typical requirements that are often placed on Vishay products in generic applications. Such statements are not binding statements about the suitability of products for a particular application. It is the customer's responsibility to validate that a particular product with the properties described in the product specification is suitable for use in a particular application. Parameters provided in datasheets and / or specifications may vary in different applications and performance may vary over time. All operating parameters, including typical parameters, must be validated for each customer application by the customer's technical experts. Product specifications do not expand or otherwise modify Vishay's terms and conditions of purchase, including but not limited to the warranty expressed therein.

Except as expressly indicated in writing, Vishay products are not designed for use in medical, life-saving, or life-sustaining applications or for any other application in which the failure of the Vishay product could result in personal injury or death. Customers using or selling Vishay products not expressly indicated for use in such applications do so at their own risk. Please contact authorized Vishay personnel to obtain written terms and conditions regarding products designed for such applications.

No license, express or implied, by estoppel or otherwise, to any intellectual property rights is granted by this document or by any conduct of Vishay. Product names and markings noted herein may be trademarks of their respective owners.

Mouser Electronics

Authorized Distributor

Click to View Pricing, Inventory, Delivery & Lifecycle Information:

Vishay:

[SQJ940EP-T1-GE3](#) [SQJ940EP-T1_GE3](#)