

Insulated Gate Bipolar Transistor Trench PT IGBT, 600 V, 250 A

Proprietary Vishay IGBT Silicon “L Series”



SOT-227

PRODUCT SUMMARY	
V_{CES}	600 V
I_C DC ⁽¹⁾	239 A at 90 °C
$V_{CE(on)}$ typical at 100 A, 25 °C	1.10 V
Speed	DC to 1 kHz
Package	SOT-227
Circuit	Single switch no diode

Note

⁽¹⁾ Maximum continuous collector current 100 A to do not exceed the maximum temperature of terminals

FEATURES

- Standard speed Trench PT IGBT
- Fully isolated package
- Very low internal inductance (≤ 5 nH typical)
- Industry standard outline
- UL approved file E78996
- Material categorization: for definitions of compliance please see www.vishay.com/doc?99912



**RoHS
COMPLIANT**

BENEFITS

- Optimized for high current inverter stages (AC TIG welding machine)
- Direct mounting to heatsink
- Plug-in compatible with other SOT-227 packages
- Lower conduction losses
- Low EMI, requires less snubbing

ABSOLUTE MAXIMUM RATINGS				
PARAMETER	SYMBOL	TEST CONDITIONS	MAX.	UNITS
Collector to emitter voltage	V_{CES}		600	V
Continuous collector current	I_C	$T_C = 25\text{ °C}$	380	A
		$T_C = 90\text{ °C}$	239	
Pulsed collector current	I_{CM}		600	
Clamped inductive load current	I_{LM}		400	
Gate-to-emitter voltage	V_{GE}		± 20	V
Power dissipation, IGBT	P_D	$T_C = 25\text{ °C}$	893	W
		$T_C = 90\text{ °C}$	429	
Isolation voltage	V_{ISOL}	Any terminal to case, $t = 1$ min	2500	V

ELECTRICAL SPECIFICATIONS ($T_J = 25\text{ °C}$ unless otherwise specified)						
PARAMETER	SYMBOL	TEST CONDITIONS	MIN.	TYP.	MAX.	UNITS
Collector to emitter breakdown voltage	$V_{BR(CES)}$	$V_{GE} = 0\text{ V}, I_C = 250\text{ }\mu\text{A}$	600	-	-	V
Collector to emitter voltage	$V_{CE(on)}$	$V_{GE} = 15\text{ V}, I_C = 100\text{ A}$	-	1.10	1.30	
		$V_{GE} = 15\text{ V}, I_C = 100\text{ A}, T_J = 125\text{ °C}$	-	1.03	-	
		$V_{GE} = 15\text{ V}, I_C = 100\text{ A}, T_J = 150\text{ °C}$	-	1.0	-	
Gate threshold voltage	$V_{GE(th)}$	$V_{CE} = V_{GE}, I_C = 3.2\text{ mA}$	4.1	6.1	8.1	
		$V_{CE} = V_{GE}, I_C = 3.2\text{ mA}, T_J = 125\text{ °C}$	-	3.5	-	
Temperature coefficient of threshold voltage	$\Delta V_{GE(th)}/\Delta T_J$	$V_{CE} = V_{GE}, I_C = 3.2\text{ mA}, (25\text{ °C to }125\text{ °C})$	-	-26	-	mV/°C
Collector to emitter leakage current	I_{CES}	$V_{GE} = 0\text{ V}, V_{CE} = 600\text{ V}$	-	1.0	100	μA
		$V_{GE} = 0\text{ V}, V_{CE} = 600\text{ V}, T_J = 125\text{ °C}$	-	350	-	
		$V_{GE} = 0\text{ V}, V_{CE} = 600\text{ V}, T_J = 150\text{ °C}$	-	700	-	
Gate to emitter leakage current	I_{GES}	$V_{GE} = \pm 20\text{ V}$	-	-	± 350	nA



SWITCHING CHARACTERISTICS ($T_J = 25\text{ }^\circ\text{C}$ unless otherwise specified)									
PARAMETER	SYMBOL	TEST CONDITIONS		MIN.	TYP.	MAX.	UNITS		
Total gate charge (turn-on)	Q_g	$I_C = 100\text{ A}, V_{CC} = 400\text{ V}, V_{GE} = 15\text{ V}$		-	942	-	nC		
Gate to emitter charge (turn-on)	Q_{ge}			-	295	-			
Gate to collector charge (turn-on)	Q_{gc}			-	802	-			
Turn-on switching loss	E_{on}	$I_C = 100\text{ A}, V_{CC} = 480\text{ V}, V_{GE} = 15\text{ V}, R_g = 5\text{ }\Omega, L = 500\text{ }\mu\text{H}, T_J = 25\text{ }^\circ\text{C}$		-	2.2	-	mJ		
Turn-off switching loss	E_{off}			-	11	-			
Total switching loss	E_{tot}			-	13.2	-			
Turn-on delay time	$t_{d(on)}$			$I_C = 100\text{ A}, V_{CC} = 480\text{ V}, V_{GE} = 15\text{ V}, R_g = 5\text{ }\Omega, L = 500\text{ }\mu\text{H}, T_J = 125\text{ }^\circ\text{C}$		-	300	-	ns
Rise time	t_r					-	85	-	
Turn-off delay time	$t_{d(off)}$					-	515	-	
Fall time	t_f	-	450			-			
Turn-on switching loss	E_{on}	$I_C = 100\text{ A}, V_{CC} = 480\text{ V}, V_{GE} = 15\text{ V}, R_g = 5\text{ }\Omega, L = 500\text{ }\mu\text{H}, T_J = 125\text{ }^\circ\text{C}$				-	2.6	-	mJ
Turn-off switching loss	E_{off}					-	21.5	-	
Total switching loss	E_{tot}			-	24.1	-			
Turn-on delay time	$t_{d(on)}$			Energy losses include tail and diode recovery. diode used 60APH06		-	285	-	ns
Rise time	t_r					-	85	-	
Turn-off delay time	$t_{d(off)}$					-	785	-	
Fall time	t_f	-	790			-			
Reverse bias safe operating area	RBSOA	$T_J = 150\text{ }^\circ\text{C}, I_C = 400, R_g = 5\text{ }\Omega, V_{GE} = 15\text{ V to } 0\text{ V}, V_{CC} = 480\text{ V}, V_P = 600\text{ V}, L = 500\text{ }\mu\text{H}$		Fullsquare					

THERMAL AND MECHANICAL SPECIFICATIONS						
PARAMETER	SYMBOL	TEST CONDITIONS	MIN.	TYP.	MAX.	UNITS
Junction and storage temperature range	T_J, T_{Stg}		-40	-	150	$^\circ\text{C}$
Junction to case	R_{thJC}		-	-	0.14	$^\circ\text{C/W}$
Case to heatsink	R_{thCS}	Flat, greased surface	-	0.1	-	
Weight			-	30	-	g
Mounting torque		Torque to terminal	-	-	1.1 (9.7)	Nm (lbf.in)
		Torque to heatsink	-	-	1.3 (11.5)	Nm (lbf.in)
Case style		SOT-227				

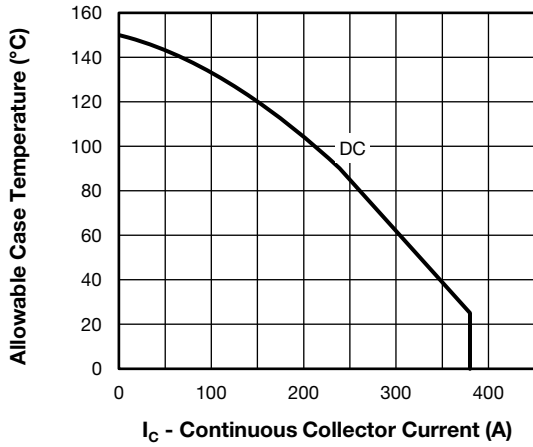

Fig. 1 - Maximum DC IGBT Collector Current vs. Case Temperature

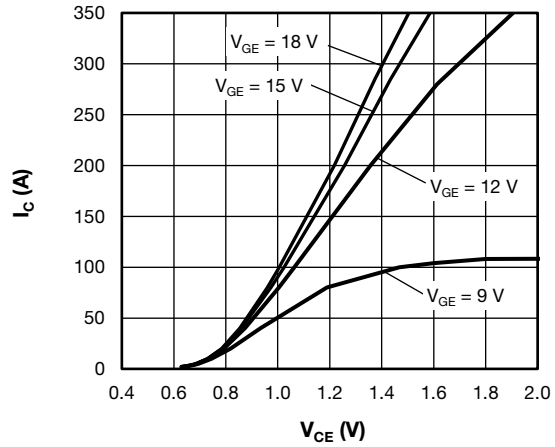

Fig. 4 - Typical Output Characteristics vs. V_{GE} at 125 °C

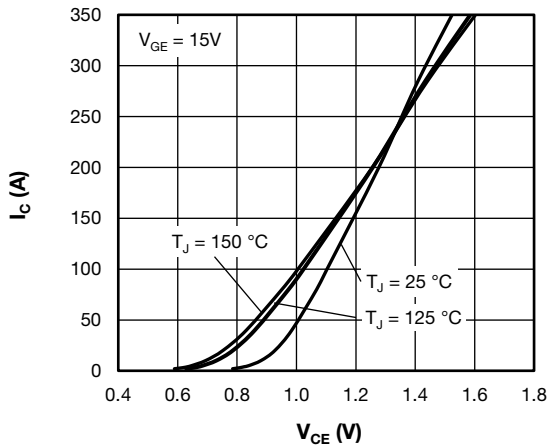

Fig. 2 - Typical IGBT Output Characteristics vs. $V_{GE} = 15 V$

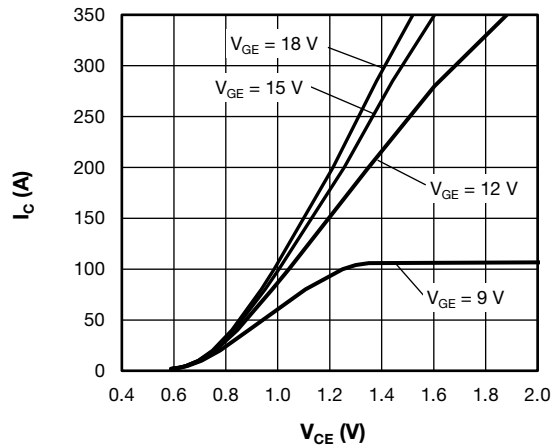

Fig. 5 - Typical Output Characteristics vs. V_{GE} at 150 °C

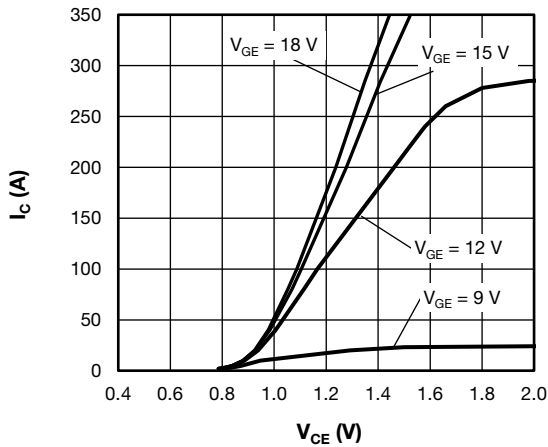

Fig. 3 - Typical Output Characteristics vs. V_{GE} at 25 °C

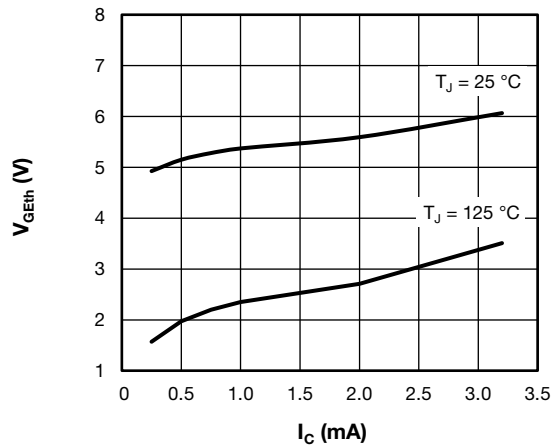

Fig. 6 - Typical Gate Threshold Voltage Characteristics

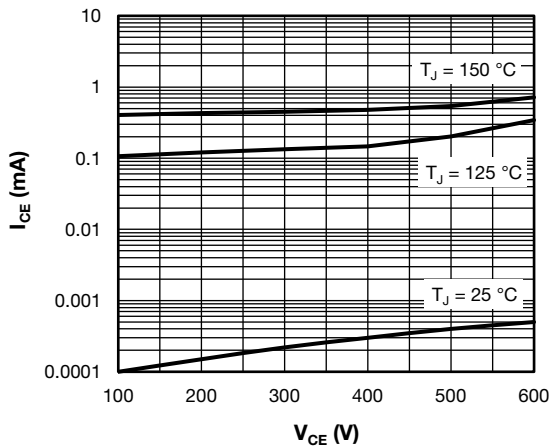

Fig. 7 - Typical Zero Voltage Collector Current

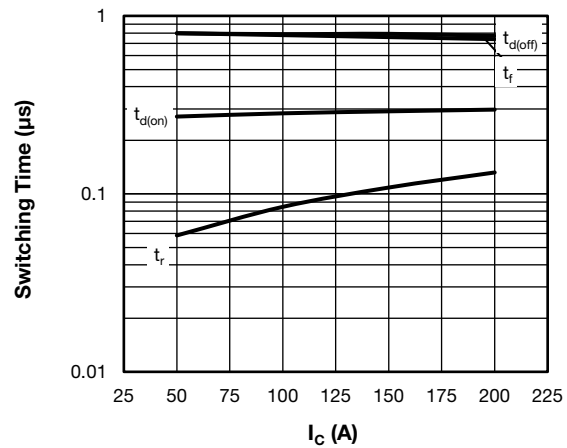

Fig. 10 - Typical IGBT Switching Time vs. I_C
 $T_J = 125\text{ °C}$, $V_{CC} = 480\text{ V}$, $V_{GE} = 15\text{ V}$, $L = 500\text{ μH}$, $R_g = 5\text{ Ω}$
Diode used: 60APH06

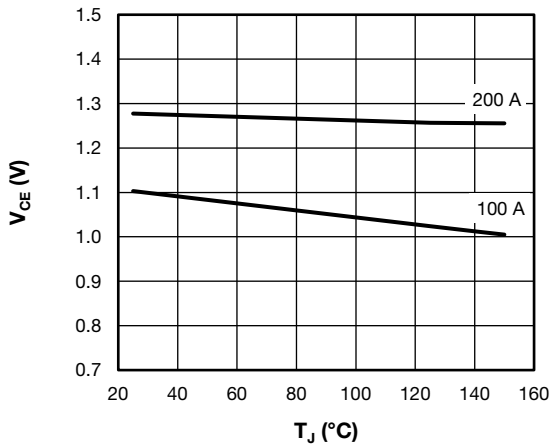

Fig. 8 - Typical V_{CE} vs. Junction Temperature

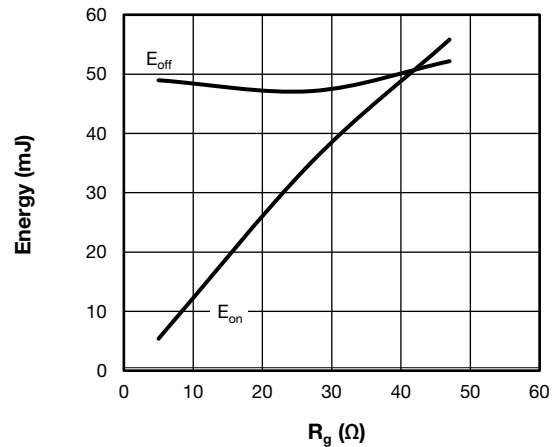

Fig. 11 - Typical IGBT Energy Losses vs. R_g
 $T_J = 125\text{ °C}$, $I_C = 200\text{ A}$, $V_{CC} = 480\text{ V}$, $V_{GE} = 15\text{ V}$, $L = 500\text{ μH}$,
 $R_g = 5\text{ Ω}$, Diode used: 60APH06

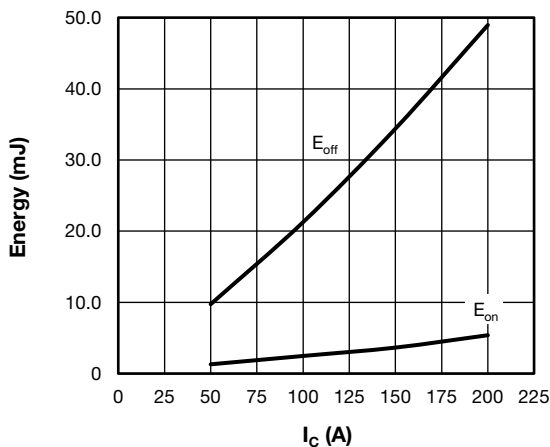

Fig. 9 - Typical IGBT Energy Losses vs. I_C
 $T_J = 125\text{ °C}$, $V_{CC} = 480\text{ V}$, $V_{GE} = 15\text{ V}$, $L = 500\text{ μH}$, $R_g = 5\text{ Ω}$
Diode used: 60APH06

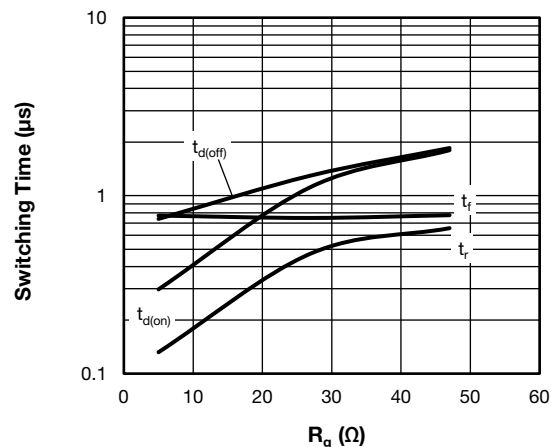

Fig. 12 - Typical IGBT Switching Time vs. R_g
 $T_J = 125\text{ °C}$, $I_C = 200\text{ A}$, $V_{CC} = 480\text{ V}$, $V_{GE} = 15\text{ V}$, $L = 500\text{ μH}$,
 $R_g = 5\text{ Ω}$, Diode used: 60APH06

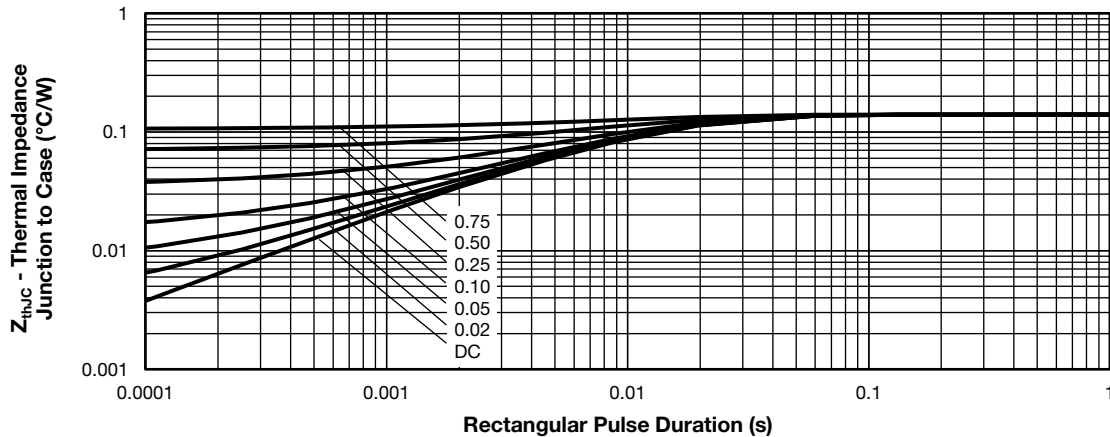

Fig. 13 - Maximum Thermal Impedance Characteristics

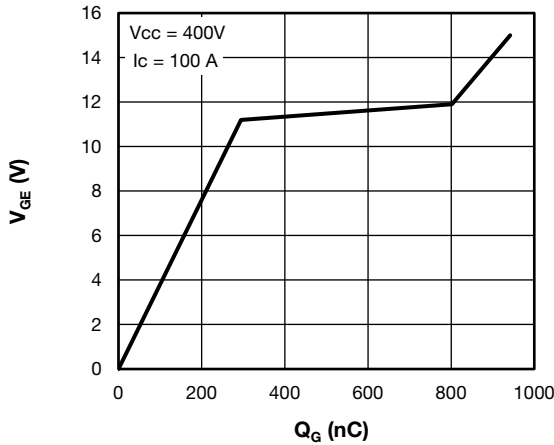
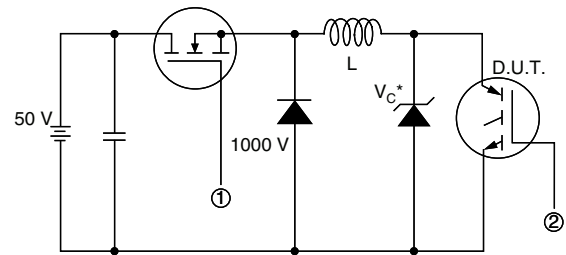

Fig. 14 - Typical Gate Charge vs. Gate Emitter Voltage



* Driver same type as D.U.T.; $V_C = 80\%$ of V_{CE} (max)
Note: Due to the 50 V power supply, pulse width and inductor will increase to obtain rated I_d

Fig. 16a - Clamped Inductive Load Test Circuit

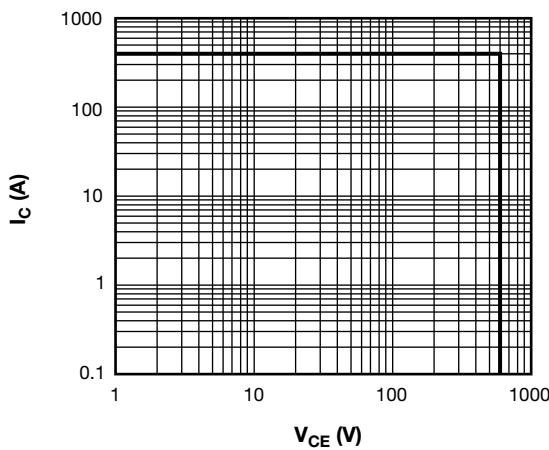

Fig. 15 - Reverse BIAS SOA, $T_J = 150\text{ }^\circ\text{C}$, $V_{GE} = 15\text{ V}$

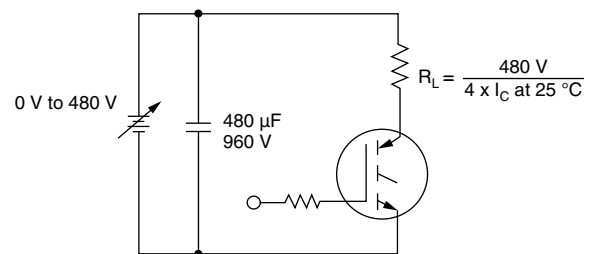
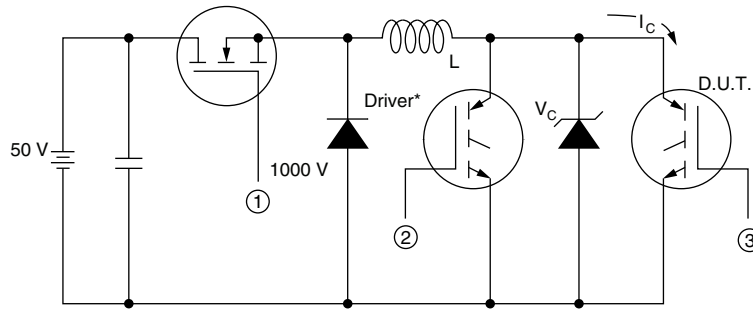

Fig. 16b - Pulsed Collector Current Test Circuit



* Driver same type as D.U.T., $V_C = 480\text{ V}$

Fig. 17a - Switching Lost Test Circuit

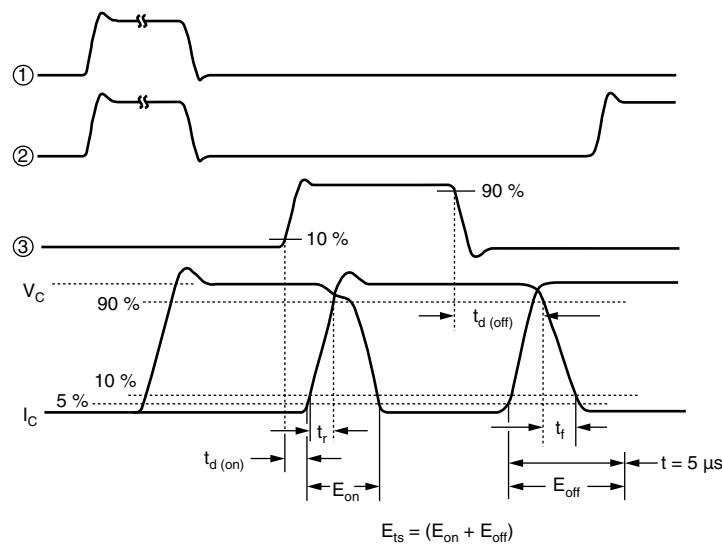

Fig. 17b - Switching Loss Waveforms

ORDERING INFORMATION TABLE

Device code	VS-	G	P	250	S	A	60	S
	①	②	③	④	⑤	⑥	⑦	⑧

- 1** - Vishay Semiconductors product
- 2** - Insulated Gate Bipolar Transistor (IGBT)
- 3** - P = Trench PT IGBT
- 4** - Current rating (250 = 250 A)
- 5** - Circuit configuration (S = single switch, no diode)
- 6** - Package indicator (A = SOT-227)
- 7** - Voltage rating (60 = 600 V)
- 8** - Speed/type (S = standard speed)



CIRCUIT CONFIGURATION		
CIRCUIT	CIRCUIT CONFIGURATION CODE	CIRCUIT DRAWING
Single switch, no diode	S	

LINKS TO RELATED DOCUMENTS	
Dimensions	www.vishay.com/doc?95423
Packaging information	www.vishay.com/doc?95425



SOT-227 Generation II

DIMENSIONS in millimeters (inches)

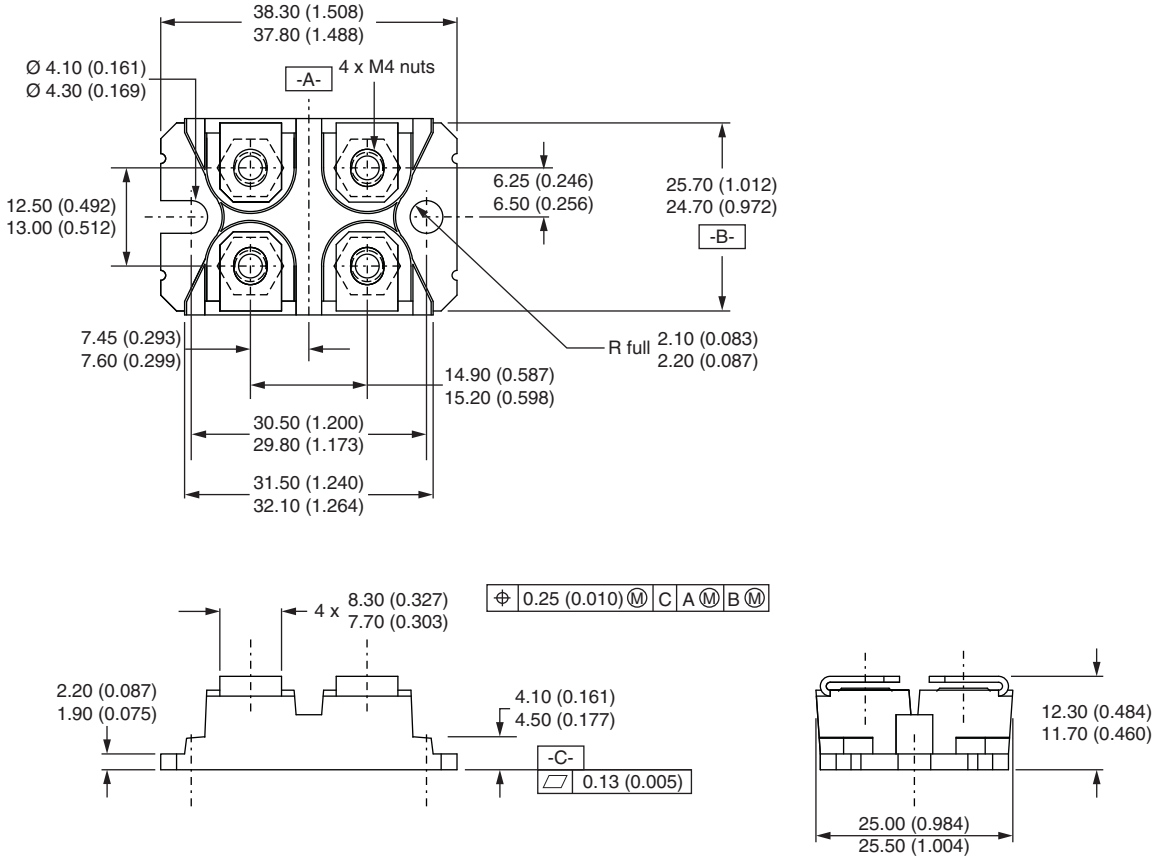

Note

- Controlling dimension: millimeter



Disclaimer

ALL PRODUCT, PRODUCT SPECIFICATIONS AND DATA ARE SUBJECT TO CHANGE WITHOUT NOTICE TO IMPROVE RELIABILITY, FUNCTION OR DESIGN OR OTHERWISE.

Vishay Intertechnology, Inc., its affiliates, agents, and employees, and all persons acting on its or their behalf (collectively, "Vishay"), disclaim any and all liability for any errors, inaccuracies or incompleteness contained in any datasheet or in any other disclosure relating to any product.

Vishay makes no warranty, representation or guarantee regarding the suitability of the products for any particular purpose or the continuing production of any product. To the maximum extent permitted by applicable law, Vishay disclaims (i) any and all liability arising out of the application or use of any product, (ii) any and all liability, including without limitation special, consequential or incidental damages, and (iii) any and all implied warranties, including warranties of fitness for particular purpose, non-infringement and merchantability.

Statements regarding the suitability of products for certain types of applications are based on Vishay's knowledge of typical requirements that are often placed on Vishay products in generic applications. Such statements are not binding statements about the suitability of products for a particular application. It is the customer's responsibility to validate that a particular product with the properties described in the product specification is suitable for use in a particular application. Parameters provided in datasheets and / or specifications may vary in different applications and performance may vary over time. All operating parameters, including typical parameters, must be validated for each customer application by the customer's technical experts. Product specifications do not expand or otherwise modify Vishay's terms and conditions of purchase, including but not limited to the warranty expressed therein.

Except as expressly indicated in writing, Vishay products are not designed for use in medical, life-saving, or life-sustaining applications or for any other application in which the failure of the Vishay product could result in personal injury or death. Customers using or selling Vishay products not expressly indicated for use in such applications do so at their own risk. Please contact authorized Vishay personnel to obtain written terms and conditions regarding products designed for such applications.

No license, express or implied, by estoppel or otherwise, to any intellectual property rights is granted by this document or by any conduct of Vishay. Product names and markings noted herein may be trademarks of their respective owners.

Mouser Electronics

Authorized Distributor

Click to View Pricing, Inventory, Delivery & Lifecycle Information:

[Vishay:](#)

[VS-GP250SA60S](#)